



## **SMT power inductors**

Size 10.4 × 10.0 × 5.8 (mm)

**Series/Type:** B82475A1  
**Date:** October 2009

Rated inductance 10 ..H to 680 ..H  
Rated current 0.28 A to 2.6 A



### Construction

- Ferrite core
- Winding: enamel copper wire
- Winding soldered to terminals
- Plastic terminal carrier

### Features

- Temperature range up to 150 °C
- High rated current
- Low DC resistance
- Suitable for lead-free reflow soldering as referenced in JEDEC J-STD 020C
- Qualification based on AEC-Q200
- RoHS-compatible

### Applications

- Filtering of supply voltages
- Coupling, decoupling
- DC/DC converters
- Automotive electronics
- Industrial electronics
- Consumer electronics

### Terminals

- Base material CuSn6P
- Layer composition Ni, Sn (lead-free)
- Electro-plated

### Marking

- Marking on component:  
Manufacturer, L value (μH, coded),  
manufacturing date (YWWD)
- Minimum data on reel:  
Manufacturer, ordering code, L value,  
quantity, date of packing

### Delivery mode and packing unit

- 24-mm blister tape, wound on 330-mm Ø reel
- Packing unit: 500 pcs./reel

**SMD**

**Dimensional drawing and layout recommendation**

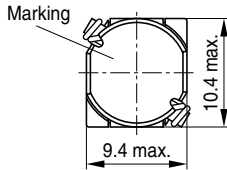
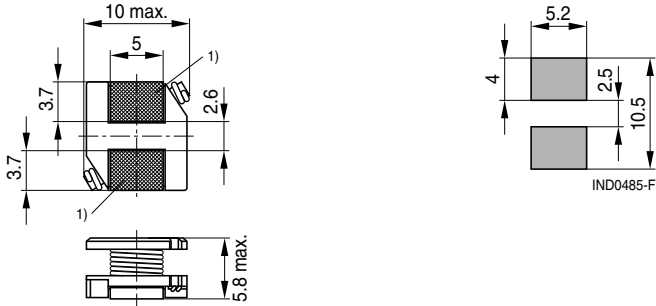

1) Soldering area

IND0484-A-E

Dimensions in mm

Component tolerances  $\pm 0.2$  mm unless otherwise noted.

**Taping and packing**

**Blister tape**

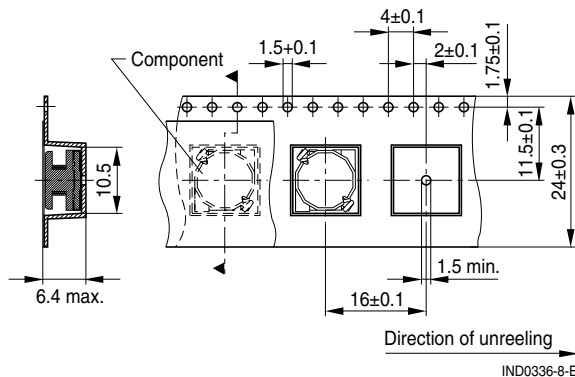

**Reel**

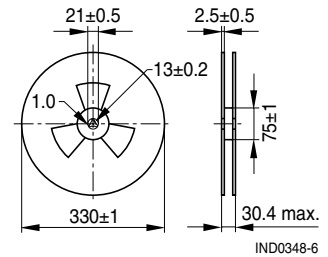

Dimensions in mm

**Technical data and measuring conditions**

Rated inductance $L_R$	Measured with LCR meter Agilent 4284A at frequency $f_L$ , at 0.1 V, 20 °C
Rated temperature $T_R$	85 °C
Rated current $I_R$	Max. permissible DC with temperature increase of $\leq 40$ K at rated temperature
Saturation current $I_{sat}$	Max. permissible DC with inductance decrease $\Delta L/L_0$ of approx. 10%
DC resistance $R_{max}$	Measured at 20 °C
Solderability (lead-free)	Dip and look method Sn95.5Ag3.8Cu0.7: (245 ±5) °C, (5 ±0.3) s Wetting of soldering area $\geq 90\%$ (based on IEC 60068-2-58)
Resistance to soldering heat	260 °C, 40 s (as referenced in JEDEC J-STD 020C)
Climatic category	55/150/56 (to IEC 60068-1)
Storage conditions	Mounted: -55 °C ... +150 °C Packaged: -25 °C ... +40 °C, $\leq 75\%$ RH
Weight	Approx. 1.5 g

**Characteristics and ordering codes**

$L_R$ $\mu\text{H}$	Tolerance	$f_L$ MHz	$I_R$ A	$I_{sat}$ A	$R_{max}$ $\Omega$	Ordering code
10	$\pm 20\% \triangleq M$	0.1	2.60	2.75	0.06	B82475A1103M000
15		0.1	2.27	2.35	0.08	B82475A1153M000
22		0.1	1.95	2.00	0.10	B82475A1223M000
33		0.1	1.50	1.60	0.12	B82475A1333M000
47	$\pm 10\% \triangleq K$	0.1	1.28	1.35	0.17	B82475A1473K000
68		0.1	1.11	1.20	0.22	B82475A1683K000
100		0.1	0.97	1.00	0.35	B82475A1104K000
150		0.1	0.78	0.82	0.47	B82475A1154K000
220		0.1	0.66	0.70	0.73	B82475A1224K000
330		0.1	0.52	0.55	1.15	B82475A1334K000
470		0.1	0.42	0.45	1.48	B82475A1474K000
680		0.1	0.28	0.30	2.25	B82475A1684K000

Sample kit available. Ordering code: B8247XX001  
For more information refer to chapter "Sample kits".

**SMD**

**Impedance  $|Z|$  versus frequency  $f$**   
 measured with impedance analyzer  
 Agilent 4294A, typical values at 20 °C

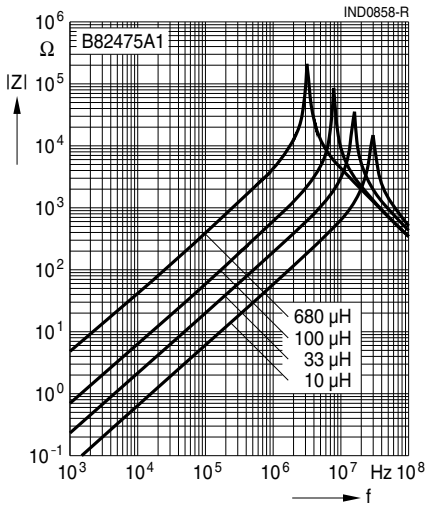

**Inductance  $L$  versus DC load current  $I_{DC}$**   
 measured with LCR meter Agilent 4275A,  
 typical values at 20 °C

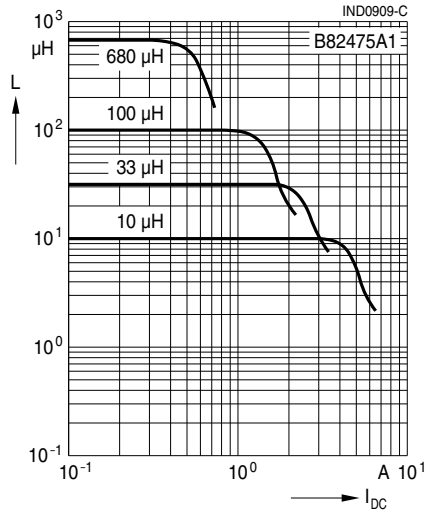

**Current derating  $I_{op}/I_R$**   
**versus ambient temperature  $T_A$**   
 (rated temperature  $T_R = 85 °C$ )

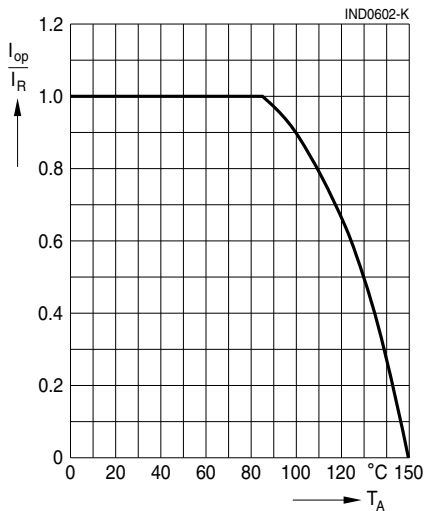

## Cautions and warnings

- Please note the recommendations in our Inductors data book (latest edition) and in the data sheets.
  - Particular attention should be paid to the derating curves given there.
  - The soldering conditions should also be observed. Temperatures quoted in relation to wave soldering refer to the pin, not the housing.
- If the components are to be washed varnished it is necessary to check whether the washing varnish agent that is used has a negative effect on the wire insulation, any plastics that are used, or on glued joints. In particular, it is possible for washing varnish agent residues to have a negative effect in the long-term on wire insulation.
- The following points must be observed if the components are potted in customer applications:
  - Many potting materials shrink as they harden. They therefore exert a pressure on the plastic housing or core. This pressure can have a deleterious effect on electrical properties, and in extreme cases can damage the core or plastic housing mechanically.
  - It is necessary to check whether the potting material used attacks or destroys the wire insulation, plastics or glue.
  - The effect of the potting material can change the high-frequency behaviour of the components.
- Ferrites are sensitive to direct impact. This can cause the core material to flake, or lead to breakage of the core.
- Even for customer-specific products, conclusive validation of the component in the circuit can only be carried out by the customer.

## Important notes

The following applies to all products named in this publication:

1. Some parts of this publication contain **statements about the suitability of our products for certain areas of application**. These statements are based on our knowledge of typical requirements that are often placed on our products in the areas of application concerned. We nevertheless expressly point out **that such statements cannot be regarded as binding statements about the suitability of our products for a particular customer application**. As a rule, EPCOS is either unfamiliar with individual customer applications or less familiar with them than the customers themselves. For these reasons, it is always ultimately incumbent on the customer to check and decide whether an EPCOS product with the properties described in the product specification is suitable for use in a particular customer application.
2. We also point out that **in individual cases, a malfunction of electronic components or failure before the end of their usual service life cannot be completely ruled out in the current state of the art, even if they are operated as specified**. In customer applications requiring a very high level of operational safety and especially in customer applications in which the malfunction or failure of an electronic component could endanger human life or health (e.g. in accident prevention or life-saving systems), it must therefore be ensured by means of suitable design of the customer application or other action taken by the customer (e.g. installation of protective circuitry or redundancy) that no injury or damage is sustained by third parties in the event of malfunction or failure of an electronic component.
3. **The warnings, cautions and product-specific notes must be observed.**
4. In order to satisfy certain technical requirements, **some of the products described in this publication may contain substances subject to restrictions in certain jurisdictions (e.g. because they are classed as hazardous)**. Useful information on this will be found in our Material Data Sheets on the Internet ([www.epcos.com/material](http://www.epcos.com/material)). Should you have any more detailed questions, please contact our sales offices.
5. We constantly strive to improve our products. Consequently, **the products described in this publication may change from time to time**. The same is true of the corresponding product specifications. Please check therefore to what extent product descriptions and specifications contained in this publication are still applicable before or when you place an order.

We also **reserve the right to discontinue production and delivery of products**. Consequently, we cannot guarantee that all products named in this publication will always be available. The aforementioned does not apply in the case of individual agreements deviating from the foregoing for customer-specific products.

6. Unless otherwise agreed in individual contracts, **all orders are subject to the current version of the “General Terms of Delivery for Products and Services in the Electrical Industry” published by the German Electrical and Electronics Industry Association (ZVEI)**.
7. The trade names EPCOS, BAOKE, Alu-X, CeraDiode, CSMP, CSSP, CTVS, DSSP, MiniBlue, MiniCell, MKK, MLSC, MotorCap, PCC, PhaseCap, PhaseCube, PhaseMod, PhiCap, SIFERRIT, SIFI, SIKOREL, SilverCap, SIMDAD, SIMID, SineFormer, SIOV, SIP5D, SIP5K, ThermoFuse, WindCap are **trademarks registered or pending** in Europe and in other countries. Further information will be found on the Internet at [www.epcos.com/trademarks](http://www.epcos.com/trademarks).