



Solid-Electrolyte TANTALEX[®] Capacitors for High Frequency Power Supplies



FEATURES

- Hermetically-sealed, axial-lead solid tantalum capacitors
- Small size and long life
- Exceptional capacitance stability and excellent resistance to severe environmental conditions
- The military equivalent is the CSR21 which is qualified to MIL-C-39003/09

APPLICATIONS

Designed for power supply filtering applications at above 100kHz

PERFORMANCE CHARACTERISTICS

Operating Temperature: - 55°C to + 85°C. (To + 125°C with voltage derating.)

Capacitance Tolerance: At 120 Hz, + 25°C. ± 20% and ± 10% standard. ± 5% available as a special.

Dissipation Factor: At 120 Hz, + 25°C. Dissipation factor, as determined from the expression $2\pi fRC$, shall not exceed the values listed in the Standard Ratings Tables.

DC Leakage Current (DCL Max.):

At + 25°C: Leakage current shall not exceed the values listed in the Standard Ratings Tables.

At + 85°C: Leakage current shall not exceed 10 times the values listed in the Standard Ratings Tables.

At +125°C: Leakage current shall not exceed 15 times the values listed in the Standard Ratings Tables.

Life Test: Capacitors shall withstand rated DC voltage applied at + 85°C for 2000 hours or derated DC voltage applied at + 125°C for 1000 hours.

Following the life test:

1. DCL shall not exceed 125% of the initial requirement.
2. Dissipation Factor shall meet the initial requirement.
3. Change in capacitance shall not exceed ± 5%.

ORDERING INFORMATION

550D MODEL	157 CAPACITANCE	X0 CAPACITANCE TOLERANCE	006 DC VOLTAGE RATING AT + 85°C	R CASE CODE	2 STYLE NUMBER	T PACKAGING
This is expressed in picofarads. The first two digits are the significant figures. The third is the number of zeros to follow. Standard capacitance ratings are in accordance with EIA preferred number series wherever possible.		X0 = ± 20% X9 = ± 10% X5 = ± 5% Special Order.	This is expressed in volts. To complete the three-digit block, zeros precede the voltage rating.	See Ratings and Case Codes Table.	2 = Insulated sleeve.	T = Tape and Reel

DIMENSIONS in inches [millimeters]

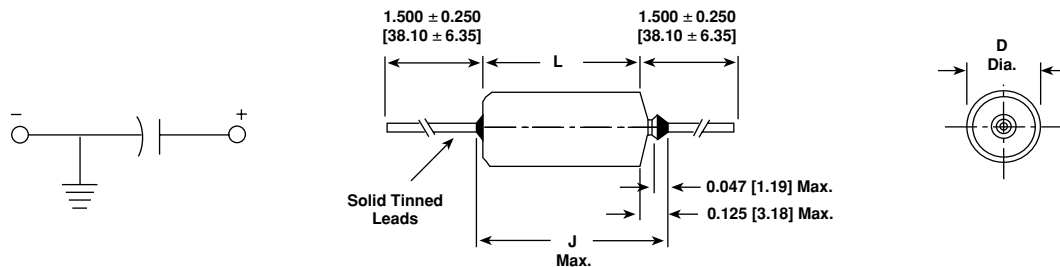

CASE CODE	WITH INSULATING SLEEVE*			LEAD SIZE	
	D	L	J (MAX.)	AWG NO.	NOM. DIA.
R	0.289 ± 0.016 [7.34 ± 0.41]	0.686 ± 0.031 [17.42 ± 0.79]	0.822 [20.88]	22	0.025 [0.64]
S	0.351 ± 0.016 [8.92 ± 0.41]	0.786 ± 0.031 [19.96 ± 0.79]	0.922 [23.42]	22	0.025 [0.64]

*When a shrink-fitted insulation is used, it shall lap over the ends of the capacitor body.

Solid-Electrolyte TANTALEX[®] Capacitors
for High Frequency Power Supplies

Vishay Sprague

STANDARD RATINGS						
CAPACITANCE (μ F)	CASE CODE	PART NUMBER* CAP. TOL. \pm 20%	PART NUMBER* CAP. TOL. \pm 10%	MAX. DCL @ + 25°C (μ A)	MAX. DF @ + 25°C 1kHz (%)	MAX. ESR @ + 25°C 100kHz (Ohms)
6 WVDC @ + 85°C, SURGE = 8 V . . . 4 WVDC @ + 125°C, SURGE = 5 V						
150	R	550D157X0006R2	550D157X9006R2	9	10	0.065
180	R	550D187X0006R2	550D187X9006R2	11	10	0.060
220	S	550D227X0006S2	550D227X9006S2	12	10	0.055
270	S	550D277X0006S2	550D277X9006S2	13	10	0.050
330	S	550D337X0006S2	550D337X9006S2	15	12	0.045
10 WVDC @ + 85°C, SURGE = 13 V . . . 7 WVDC @ + 125°C, SURGE = 9 V						
82	R	550D826X0010R2	550D826X9010R2	8	8	0.085
100	R	550D107X0010R2	550D107X9010R2	10	8	0.075
120	R	550D127X0010R2	550D127X9010R2	12	8	0.070
150	S	550D157X0010S2	550D157X9010S2	15	8	0.065
180	S	550D187X0010S2	550D187X9010S2	18	8	0.060
220	S	550D227X0010S2	550D227X9010S2	20	10	0.055
15 WVDC @ + 85°C, SURGE = 20 V . . . 10 WVDC @ + 125°C, SURGE = 12 V						
56	R	550D566X0015R2	550D566X9015R2	8	6	0.100
68	R	550D686X0015R2	550D686X9015R2	10	6	0.095
82	S	550D826X0015S2	550D826X9015S2	12	6	0.085
100	S	550D107X0015S2	550D107X9015S2	15	8	0.075
120	S	550D127X0015S2	550D127X9015S2	18	8	0.070
150	S	550D157X0015S2	550D157X9015S2	20	8	0.065
20 WVDC @ + 85°C, SURGE = 26 V . . . 13 WVDC @ + 125°C, SURGE = 16 V						
27	R	550D276X0020R2	550D276X9020R2	5	5	0.145
33	R	550D336X0020R2	550D336X9020R2	7	5	0.130
39	R	550D396X0020R2	550D396X9020R2	8	5	0.120
47	R	550D476X0020R2	550D476X9020R2	9	6	0.110
56	S	550D566X0020S2	550D566X9020S2	11	6	0.100
68	S	550D686X0020S2	550D686X9020S2	14	6	0.095
82	S	550D826X0020S2	550D826X9020S2	16	6	0.085
100	S	550D107X0020S2	550D107X9020S2	20	8	0.075
35 WVDC @ + 85°C, SURGE = 46 V . . . 23 WVDC @ + 125°C, SURGE = 28 V						
8.2	R	550D825X0035R2	550D825X9035R2	3	4	0.250
10	R	550D106X0035R2	550D106X9035R2	4	4	0.230
12	R	550D126X0035R2	550D126X9035R2	4	4	0.210
15	R	550D156X0035R2	550D156X9035R2	5	4	0.190
18	R	550D186X0035R2	550D186X9035R2	6	4	0.175
22	R	550D226X0035R2	550D226X9035R2	8	4	0.160
27	S	550D276X0035S2	550D276X9035S2	9	4	0.145
33	S	550D336X0035S2	550D336X9035S2	11	5	0.130
39	S	550D396X0035S2	550D396X9035S2	14	5	0.120
47	S	550D476X0035S2	550D476X9035S2	16	5	0.110
50 WVDC @ + 85°C, SURGE = 65 V . . . 33 WVDC @ + 125°C, SURGE = 40 V						
5.6	R	550D565X0050R2	550D565X9050R2	4	3	0.300
6.8	R	550D685X0050R2	550D685X9050R2	4	3	0.275
8.2	R	550D825X0050R2	550D825X9050R2	5	3	0.250
10.0	R	550D106X0050R2	550D106X9050R2	5	3	0.230
12.0	R	550D126X0050R2	550D126X9050R2	6	3	0.210
15.0	R	550D156X0050R2	550D156X9050R2	8	3	0.190
18.0	R	550D186X0050R2	550D186X9050R2	9	4	0.175
22.0	S	550D226X0050S2	550D226X9050S2	11	4	0.160

*Insert capacitance tolerance code "X5" for \pm 5% units (special order).



TAPE AND REEL PACKAGING in inches [millimeters]

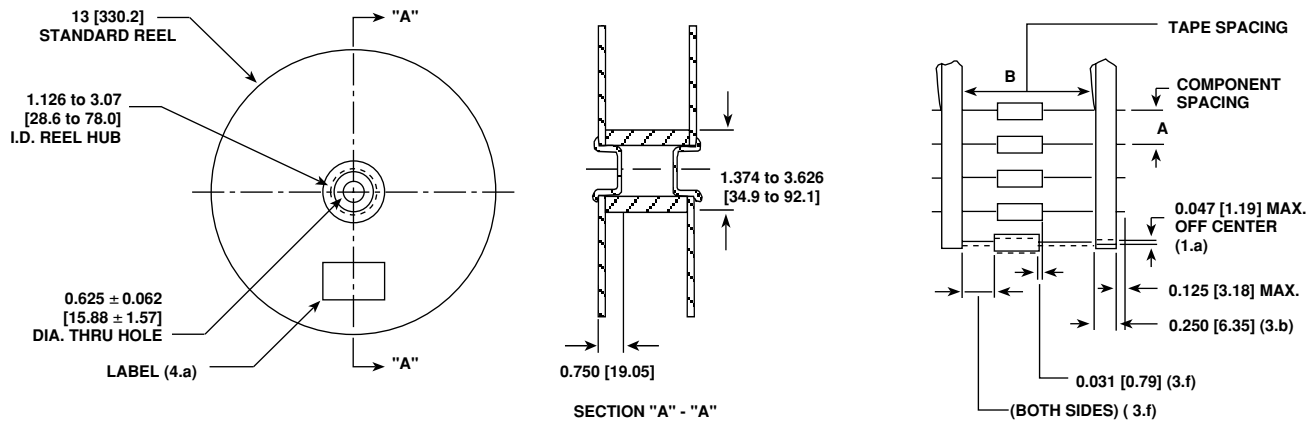

CASE CODE	TYPE 550D UNITS WITH INSULATING SLEEVE			LEAD SIZE		COMPONENT SPACING	TAPE SPACING	UNITS PER REEL
	D	L	J (MAX.)	AWG NO.	NOM. DIA.	A	B	
R	0.289 ± 0.016 [7.34 ± 0.41]	0.686 ± 0.031 [17.42 ± 0.79]	0.822 [20.88]	22	0.025 [0.64]	0.400 ± 0.015 [10.16 ± 0.38]	2.875 ± 0.062 [73.03 ± 1.57]	500
S	0.351 ± 0.016 [8.92 ± 0.41]	0.786 ± 0.031 [19.96 ± 0.79]	0.922 [23.42]	22	0.025 [0.64]	0.400 ± 0.015 [10.16 ± 0.38]	2.875 ± 0.062 [73.03 ± 1.57]	500

STANDARD REEL PACKAGING INFORMATION

1. Component Leads:

- a. Component leads shall not be bent beyond 0.047" [1.19mm] maximum from their nominal position when measured from the leading edge of the component lead at the inside tape edge and at the lead egress from the component.
- b. The 'C' dimension shall be governed by the overall length of the reel packaged component. The distance between flanges shall be 0.125" to 0.250" [3.18mm to 6.35mm] greater than the overall component length.

2. Orientation:

- a. All polarized components must be oriented to one direction. The cathode lead tape shall be a color and the anode lead tape shall be white.

3. Reeling:

- a. Components on any reel shall not represent more than two date codes when date code identification is required.
- b. Component leads shall be positioned between pairs of 0.250" [6.35mm] tape.
- c. The disposable reels have hubs with corrugated fiber board flanges and core or equivalent.
- d. A minimum of 12" [304.8mm] leader of tape shall be provided before the first and after the last component on the reel.
- e. 50 or 60 lb. Kraft paper must be wound between layer of components as far as necessary for component protection. Width of paper to be 0.062" to 0.250" [1.57mm to 6.35mm] less than the 'C' dimension of the reel.

- f. A row of components must be centered between tapes ± 0.047" [1.19mm]. In addition, individual components may deviate from center of component row ± 0.031" [0.79mm].
- g. Staples shall not be used for splicing. Not more than 4 layers of tape shall be used in any splice area and no tape shall be offset from another by more than 0.031" [0.79mm] non-cumulative. Tape splices shall overlap at least 6" [152.4mm] for butt joints and at least 3" [76.2mm] for lap joints and shall not be weaker than unspliced tape. Universal splicing clips may also be used.
- h. Quantity per reel shall be controlled so that tape components and cover shall not extend beyond the smallest dimension of the flange (either across flats or diameter). Once the quantity per reel for each part number has been established, future orders for that part number shall be packaged in that quantity. When order or release quantity is less than the established quantity, a standard commercial pack is to be used.
- i. A maximum of 0.25% of the components per reel quantity may be missing without consecutive missing components.
- j. Adequate protection must be provided to prevent physical damage to both reel and components during shipment and storage.

4. Marking:

- a. Minimum reel and carton marking shall consist of the following: Customer Part Number, Purchase Order No., Quantity, Package Date, Manufacturer's name, Electrical Value, Date Code, Vishay Sprague Part Number and Country of Origin.

TYPICAL CURVES @ + 25°C, IMPEDANCE AND ESR VS FREQUENCY

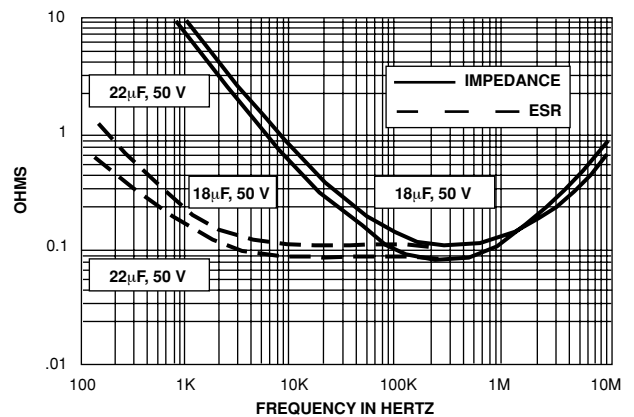
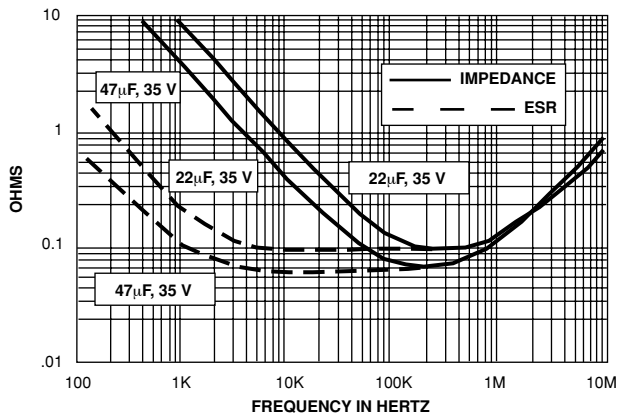
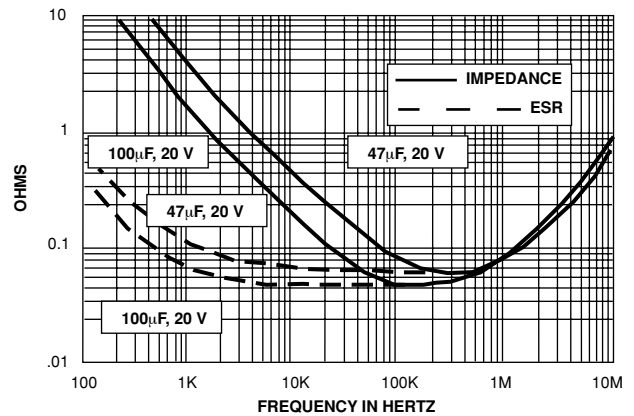
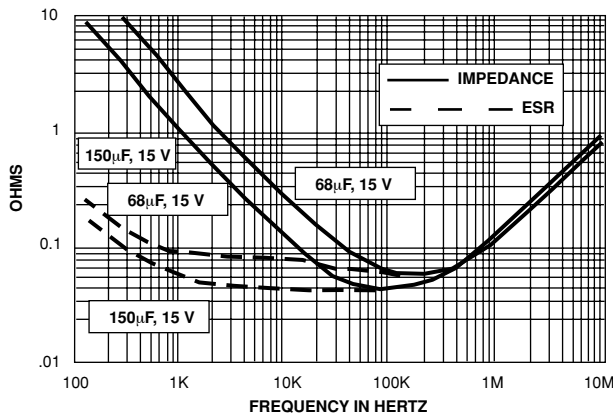
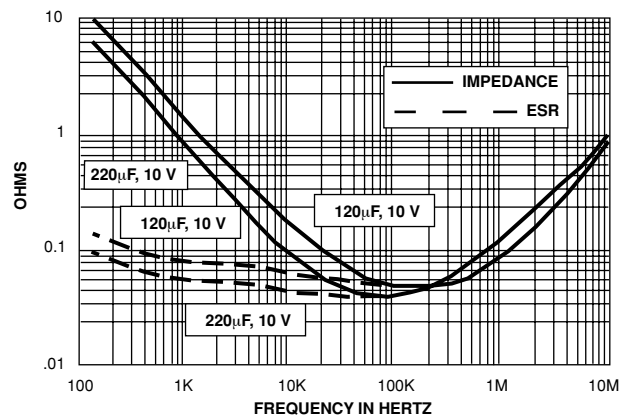
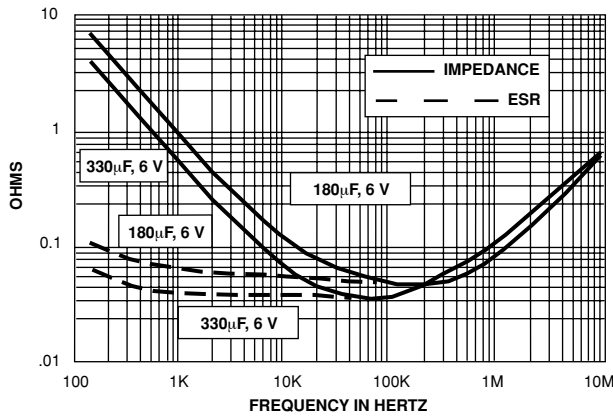



PERFORMANCE CHARACTERISTICS

- 1. **Operating Temperature:** Capacitors are designed to operate over the temperature range of - 55°C to +85°C with no derating.
- 1.1 Capacitors may be operated up to + 125°C with voltage derating to two-thirds the + 85°C rating.

+ 85°C Rating		+ 125°C Rating	
WORKING VOLTAGE (V)	SURGE VOLTAGE (V)	WORKING VOLTAGE (V)	SURGE VOLTAGE (V)
6	8	4	5
10	13	7	9
15	20	10	12
20	26	13	16
35	46	23	28
50	65	33	40

- 2. **DC Working Voltage:** The DC working voltage is the maximum operating voltage for continuous duty at the rated temperature.
- 3. **Surge Voltage:** The surge DC rating is the maximum voltage to which the capacitors may be subjected under any conditions, including transients and peak ripple at the highest line voltage.
- 3.1 **Surge Voltage Test:** Capacitors shall withstand the surge voltage applied in series with a 33 ohm ± 5% resistor at the rate of one-half minute on, one-half minute off, at + 85°C, for 1000 successive test cycles.
- 3.2 Following the surge voltage test, the dissipation factor and the leakage current shall meet the initial requirements; the capacitance shall not have changed more than ± 10%.
- 4. **Capacitance Tolerance:** The capacitance of all capacitors shall be within the specified tolerance limits of the nominal rating.
- 4.1 Capacitance measurements shall be made by means of polarized capacitance bridge. The polarizing voltage shall be of such magnitude that there shall be no reversal of polarity due to the AC component. The maximum voltage applied to capacitors during measurement shall be 2 volts rms at 1000Hz at + 25°C. If the AC voltage applied is less than one-half volt rms, no DC bias is required. Measurement accuracy of the bridge shall be within ± 2%.
- 5. **Capacitance Change With Temperature:** The capacitance change with temperature shall not exceed the following percentage of the capacitance measured at + 25%

- 55°C	+ 85°C	+ 125°C
- 10%	+ 8%	+ 12%

- 6. **Dissipation Factor:** The dissipation factor, determined from the expression $2\pi fRC$, shall not exceed values listed in the Standard Ratings Table.
- 6.1 Measurements shall be made by the bridge method at, or referred to, a frequency of 1000Hz and a temperature of + 25°C.

- 7. **Leakage Current:** Capacitors shall be stabilized at the rated temperature for 30 minutes. Rated voltage shall be applied to capacitors for 5 minutes using a steady source of power (such as a regulated power supply) with 1000 ohm resistor connected in series with the capacitor under test to limit the charging current. Leakage current shall then be measured.

Note that the leakage current varies with applied voltage. See graph below for the appropriate adjustment factor.

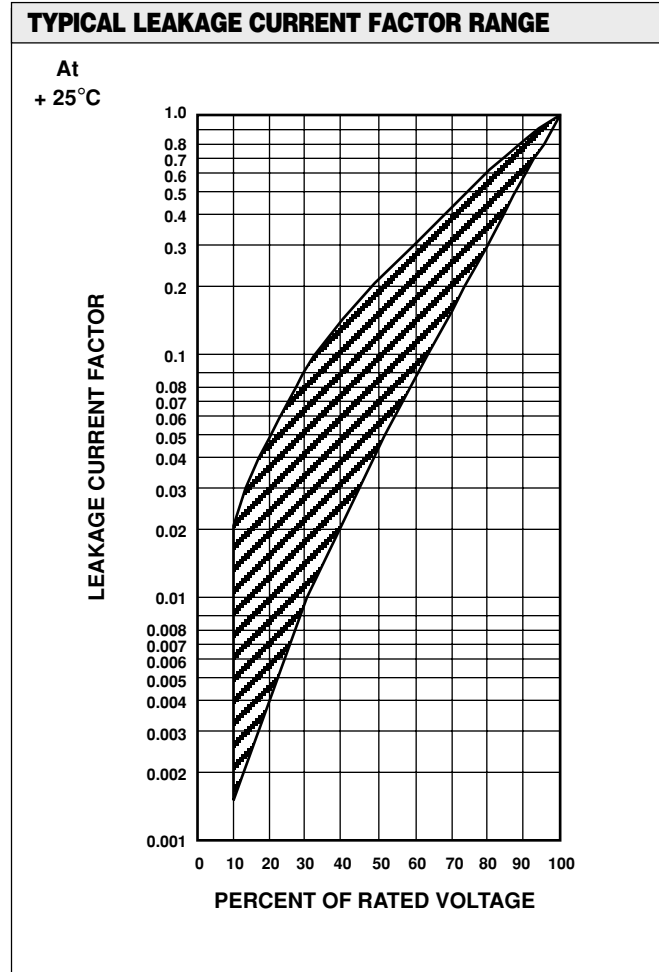

- 7.1 **At + 25°C,** the leakage current shall not exceed the value listed in the Standard Ratings Table.
- 7.2 **At + 85°C,** the leakage current shall not exceed 10 times the value listed in the Standard Ratings Table.
- 7.3 **At + 125°C,** the leakage current shall not exceed 15 times the value listed in the Standard Ratings Table.
- 8. **Life Test:** Capacitors shall withstand rated DC voltage applied at + 85°C for 2000 hours or rated DC voltage applied at + 125°C for 1000 hours.
- 8.1 Following the life test, the dissipation factor shall meet the initial requirement; the capacitance change shall not exceed ± 2%; the leakage current shall not exceed 125% of the original requirement.

9. **Shelf Test:** Capacitors shall withstand a shelf test for 5000 hours at a temperature of + 85°C, with no voltage applied.
- 9.1 Following the shelf test, the leakage current shall meet the initial requirement; the dissipation factor shall not exceed 150% of the initial requirement; the capacitance change shall not exceed $\pm 5\%$.
10. **Vibration Tests:** Capacitors shall be subjected to vibration tests in accordance with the following criteria.
- 10.1 Capacitors shall be secured for test by means of a rigid mounting using suitable brackets.
- 10.2 **Low Frequency Vibration:** Vibration shall consist of a simple harmonic motion having an amplitude of 0.03" [0.76] and a maximum total excursion of 0.06" [1.52], in a direction perpendicular to the major axis of the capacitor.
- 10.2.1 Vibration frequency shall be varied uniformly between the approximate limits of 10Hz to 55Hz during a period of approximately one minute, continuously for one and one-half hours.
- 10.2.2 A cathode ray oscilloscope or other comparable means shall be used in determining electrical intermittency during the final 30 minutes of the test. The AC voltage applied shall not exceed 2 volts rms.
- 10.2.3 Electrical tests shall show no evidence of intermittent contacts, open circuits or short circuits during these tests.
- 10.2.4 Following the low frequency vibration test, capacitors shall meet the original requirements for leakage current and dissipation factor; capacitance change shall not exceed $\pm 5\%$ of the original measured value.
- 10.3 **High Frequency Vibration:** Vibration shall consist of a simple harmonic motion having an amplitude of 0.06" [1.52] $\pm 10\%$ maximum total excursion or 20 g peak, whichever is less.
- 10.3.1 Vibration Frequency shall be varied logarithmically from 50Hz to 2000Hz and return to 50Hz during a cycle period of 20 minutes.
- 10.3.2 The vibration shall be applied for 4 hours in each of 2 directions, parallel and perpendicular to the major axis of the capacitors.
- 10.3.3 Rated DC voltage shall be applied during the vibration cycling.
- 10.3.4 A cathode ray oscilloscope or other comparable means shall be used in determining electrical intermittency during test. The AC voltage applied shall not exceed 2 volts rms.
- 10.3.5 Electrical tests shall show no evidence of intermittent contacts, open circuits or short circuits during these tests.
- 10.3.6 There shall be no mechanical damage to these capacitors as a result of these tests.
- 10.3.7 Following the high frequency vibration test, capacitors shall meet the original limits for capacitance, dissipation factor and leakage current.
11. **Acceleration Test:**
- 11.1 Capacitors shall be rigidly mounted by means of suitable brackets.
- 11.2 Capacitors shall be subjected to a constant acceleration of 100g for a period of 10 seconds in each of 2 mutually perpendicular planes.
- 11.2.1 The direction of motion shall be parallel to and perpendicular to the cylindrical axis of the capacitors.
- 11.3 Rated DC voltage shall be applied during acceleration test.
- 11.3.1 A cathode ray oscilloscope or other comparable means shall be used in determining electrical intermittency during test. The AC voltage applied shall not exceed 2 volts rms.
- 11.4 Electrical tests shall show no evidence of intermittent contacts, open circuits or short circuits during these tests.
- 11.5 There shall be no mechanical damage to these capacitors as a result of these tests.
- 11.6 Following the acceleration test, capacitors shall meet the original limits for capacitance, dissipation factor and leakage current.
10. **Shock Test:**
- 12.1 Capacitors shall be rigidly mounted by means of suitable brackets. The test load shall be distributed uniformly on the test platform to minimize the effects of unbalanced loads.
- 12.1.1 Test equipment shall be adjusted to produce a shock of 100g peak with a duration of 6 mS and a sawtooth waveform at a velocity change of 9.7 feet/second.
- 12.2 Capacitors shall be subjected to 3 shocks applied in each of 3 directions corresponding to the 3 mutually perpendicular axes of the capacitors.
- 12.3 Rated DC voltage shall be applied to capacitors during test.
- 12.3.1 A cathode ray oscilloscope or other comparable means shall be used in determining electrical intermittency during test. The AC voltage applied shall not exceed 2 volts rms.
- 12.4 Electrical tests shall show no evidence of intermittent contacts, open circuits or short circuits during these tests.
- 12.5 There shall be no mechanical damage to these capacitors as a result of these tests.
- 12.6 Following the shock test, capacitors shall meet the original limits for capacitance, dissipation factor and leakage current.



13. Moisture Resistance:

- 13.1 Capacitors shall be subjected to temperature cycling at 90% to 98% relative humidity, in a test chamber constructed of non-reactive materials (non-resiniferous and containing no formaldehyde or phenol). Steam or distilled, demineralized or deionized water having a pH value between 6.0 and 7.2 at + 23°C shall be used to obtain the required humidity. No rust, corrosive contaminants or dripping condensate shall be imposed on test specimens.
- 13.1.1 Capacitors shall be mounted by their normal mounting means in a normal mounting position and placed in a test chamber so that uniform and thorough exposure is obtained.
- 13.1.2 No conditioning or initial measurements will be performed prior to temperature cycling. Polarization and load voltages are not applicable.
- 13.1.3 Capacitors shall be subjected to temperature cycling from + 25°C to + 65°C to + 25°C (+ 10°C, -2°C) over a period of 8 hours, at 90% to 98% relative humidity, for 20 cycles.
- 13.1.4 Temperature cycling shall be stopped after an even number of cycles 5 times during the first 18 cycles, and the capacitor shall be allowed to stabilize at high humidity for 1 to 4 hours.
- 13.1.5 After stabilization, capacitors shall be removed from the humidity chamber and shall be conditioned for 3 hours at - 10°C ± 2°C.
- 13.1.6 After cold conditioning, capacitors shall be subjected to vibration cycling consisting of a simple harmonic vibration having an amplitude of 0.03" [0.76] and a maximum total excursion of 0.06" [1.52] varied uniformly from 10Hz to 55Hz to 10Hz over a period of 1 minute, for 15 cycles.
- 13.1.7 Capacitors shall then be returned to temperature/humidity cycling.
- 13.2 After completion of temperature cycling, capacitors shall be removed from the test chamber and stabilized at room temperature for 2 to 6 hours.
- 13.3 Capacitors shall show no evidence of harmful or extensive corrosion, obliteration or marking or other visible damage.
- 13.4 Following the moisture resistance test, capacitors shall meet the original limits for capacitance, dissipation factor and leakage current.

14. Insulating Sleeves:

- 14.1 Capacitors with insulating sleeves shall withstand a 2000 volt DC potential applied for 1 minute between the case and a metal 'V' block in intimate contact with the insulating sleeve.
- 14.2 Capacitors with insulating sleeves shall have the insulation resistance measured between the case and a metal 'V' block in intimate contact with the insulating sleeve. The insulation resistance shall be at least 1000 megohms.

15. Thermal Shock And Immersion Cycling:

- 15.1 Capacitors shall be conditioned prior to temperature cycling for 15 minutes at + 25°C, at less than 50% relative humidity and a barometric pressure at 28 to 31 inches.
- 15.2 Capacitors shall be subjected to thermal shock in a cycle of exposure to ambient air at - 65°C (+ 0°C, - 5°C) for 30 minutes, then, + 25°C (+ 10°C, - 5°C) for 5 minutes, then + 125°C (+ 3°C, - 0°C) for 30 minutes, then + 25°C (+ 10°C, - 5°C) for 5 minutes, for 5 cycles.
- 15.3 Between 4 and 24 hours after temperature cycling, capacitors shall be subjected to immersion in a bath of fresh tap water with the non-corrosive dye Rhodamine B added, at + 65°C (+ 5°C, - 0°C) for 15 minutes, then, within 3 seconds, immersed in a saturated solution of sodium chloride and water with Rhodamine B added, at a temperature of + 25°C (+ 10°C, - 5°C) for 15 minutes, for 2 cycles.
- 15.3.1 Capacitors shall be thoroughly rinsed and wiped or air-blasted dry immediately upon removal from immersion cycling.
- 15.4 Capacitors shall show no evidence of harmful or extensive corrosion, obliteration of marking or other visible damage.
- 15.5 Following the thermal shock immersion cycling test, capacitors shall meet the original requirements for leakage current and dissipation factor; capacitance change shall not exceed ± 5% of the original measured value.
- 15.6 Capacitors shall be opened and examined. There shall be no evidence of dye penetration.
16. **Reduced Pressure Test:**
- 16.1 Capacitors shall be stabilized at a reduced pressure of 0.315" [8.0] of mercury, equivalent to an altitude of 100,000 feet [30,480 meters], for a period of 5 minutes.
- 16.2 Rated DC voltage shall be applied for 1 minute.
- 16.3 Capacitors shall not flash over nor shall end seals be damaged.
- 16.4 Following the reduced pressure test, the capacitance, equivalent series resistance and leakage current shall meet the original requirements.
17. **Lead Pull Test:** Leads shall withstand a tensile stress of 3 pounds (1.4 kilograms) applied in any direction for 30 seconds.
17. **Marking:** Capacitors shall be marked with Sprague® or (2); the type number 550D; rated capacitance and tolerance, rated DC working voltage and the standard EIA date code.
- 18.1 Capacitors shall be marked on one end with a plus sign (+) to identify the positive terminal.
- 18.2 Sprague® reserves the right to furnish capacitors of higher working voltages than those ordered, where the physical size of the higher voltage units is identical to that of the units ordered.

GUIDE TO APPLICATION

1. **A-C Ripple Current:** The maximum allowable ripple current shall be determined from the formula:

$$I_{rms} = \sqrt{\frac{P}{R_{ESR}}}$$

P = Power Dissipation in Watts @ + 25°C as given in the table in Paragraph Number 5 (Power Dissipation).

R_{ESR} = The capacitor Equivalent Series Resistance at the specified frequency.

2. **A-C Ripple Voltage:** The maximum allowable ripple voltage shall be determined by the formula:

$$V_{rms} = Z \sqrt{\frac{P}{R_{ESR}}}$$

or, from the formula:

$$V_{rms} = I_{rms} \times Z$$

where

P = Power Dissipation in Watts @ + 25°C as given in the table in Paragraph Number 5 (Power Dissipation).

R_{ESR} = The capacitor Equivalent Series Resistance at the specified frequency.

Z = The capacitor impedance at the specified frequency.

- 2.1 The sum of the peak AC voltage plus the DC voltage shall not exceed the DC voltage rating of the capacitor.

- 2.2 The sum of the negative peak AC voltage plus the applied DC voltage shall not allow a voltage reversal exceeding 15% of the DC working voltage at + 25°C.

3. **Reverse Voltage:** These capacitors are capable of withstanding peak voltages in the reverse direction equal to 15% of the DC rating at + 25°C, 10% of the DC rating at + 55°C; 5% of the DC rating at +85°C.

4. **Temperature Derating:** If these capacitors are to be operated at temperatures above + 25°C, the permissible rms ripple current or voltage shall be calculated using the derating factors as shown:

Temperature	Derating Factor
+ 25°C	1.0
+ 55°C	0.8
+ 85°C	0.6
+ 125°C	0.4

5. **Power Dissipation:** The figures shown relate to an approximate + 20°C rise in case temperature measured in free air. Power dissipation will be affected by the heat sinking capability of the mounting surface. Non-sinusoidal ripple current may produce heating effects which differ from those shown. It is important that the equivalent *I_{rms}* value be established when calculating permissible operating levels.

Case Code	Maximum Permissible Power Dissipation @ + 25°C (Watts) in free air
R	0.185
S	0.225