

SANMOTION

2-PHASE STEPPING SYSTEMS

F2

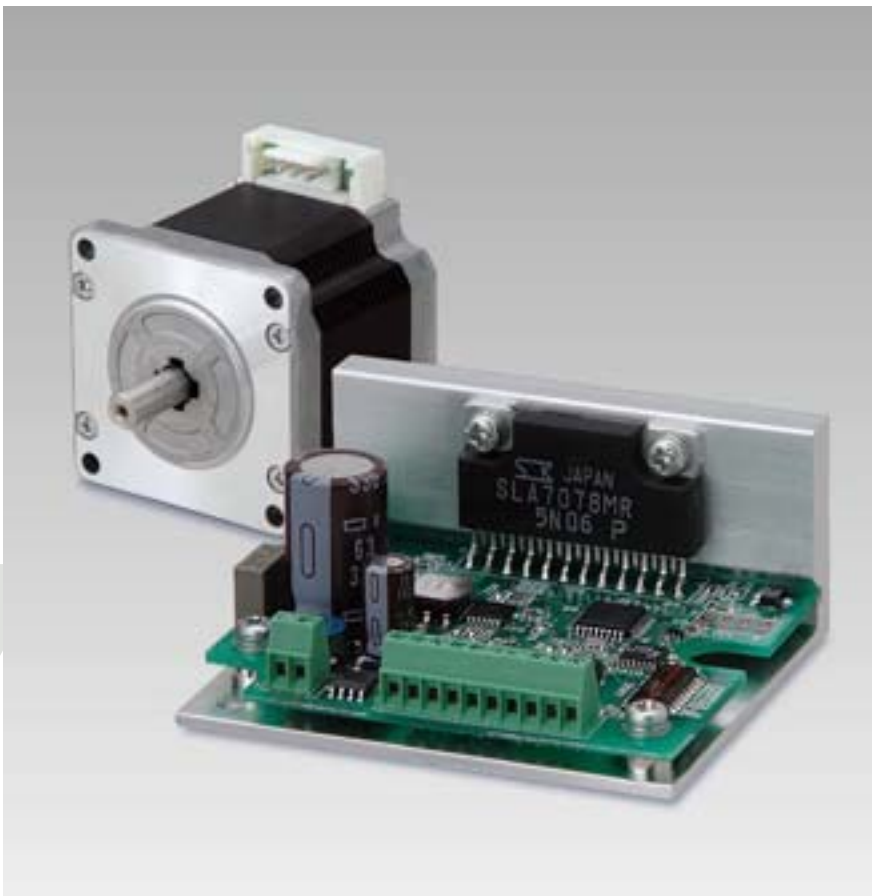

Ver.2

SANYO DENKI

F series DRIVER features

1 Low-vibration mode

DC input

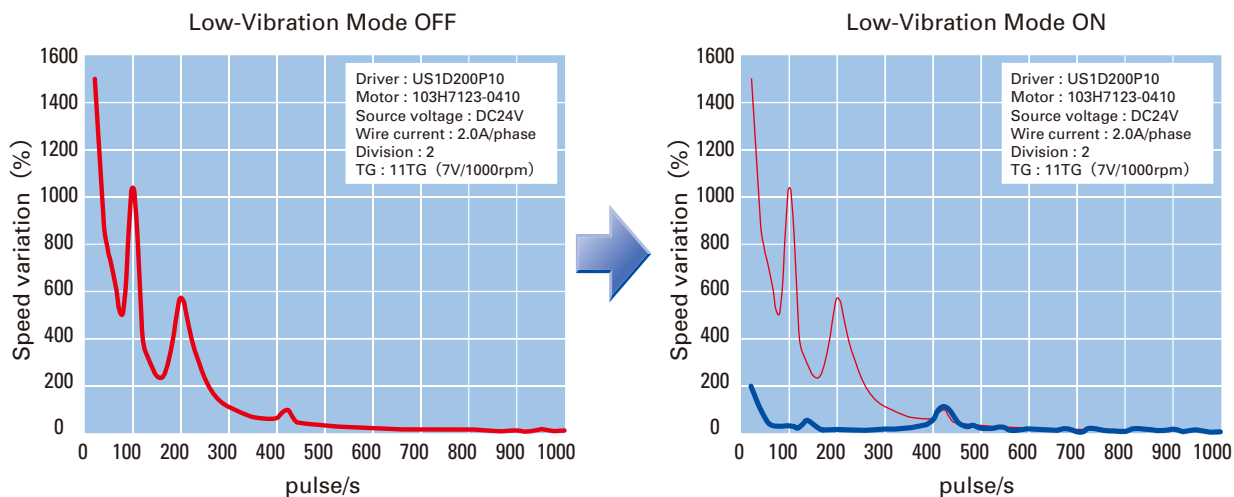

2 Compact / Light weight

DC input

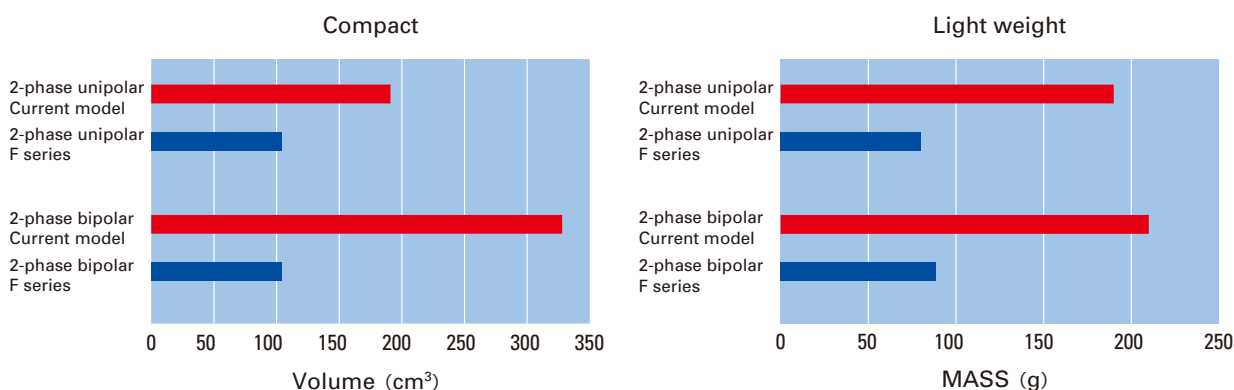

Compliance with international standards

The standard specification SANMOTION F series stepping driver complies with UL and EN safety standards. Stepping motors complying with UL and EN standards are available upon request.



DC input

Set model

DC input

Stepping motors with integrated drivers

P.4

A driver incorporating a motion control function needed for driving a motor and a 2-phase stepping motor were integrated into a single unit.

Motor flange size



Unipolar standard (standard model)

P.13

The standard set includes a F series driver and a H or SH series motor.

Motor flange size

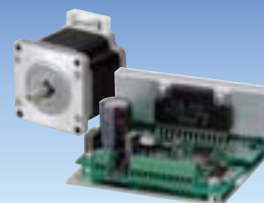

Bipolar standard (standard model)

P.14

The standard set includes a F series driver and a H or SH series motor.

Motor flange size

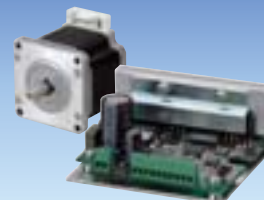

Control method

How do you want to control the equipment?

The F series offers the choice of 3 different control methods

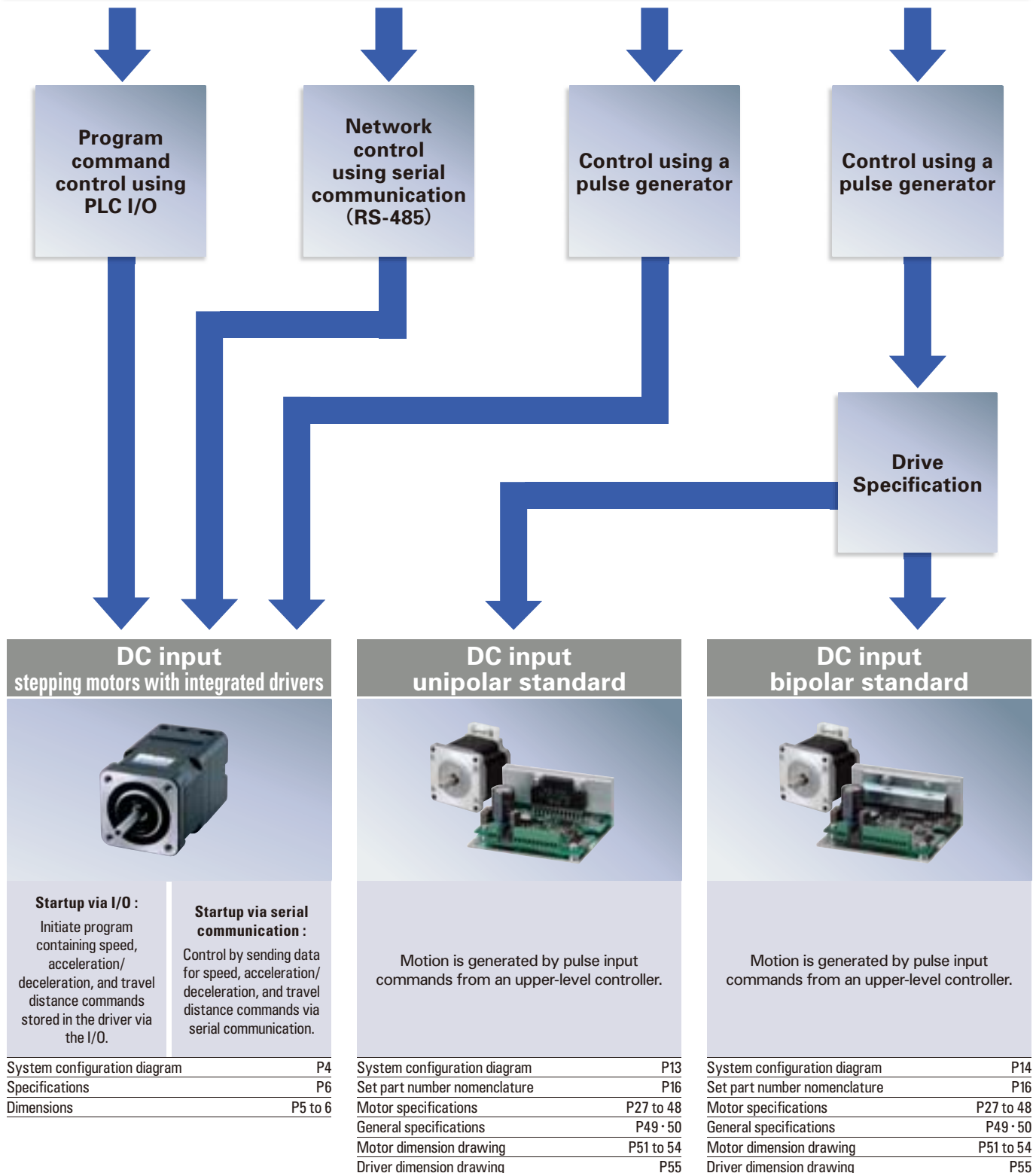

Stepping Motors with Integrated drivers

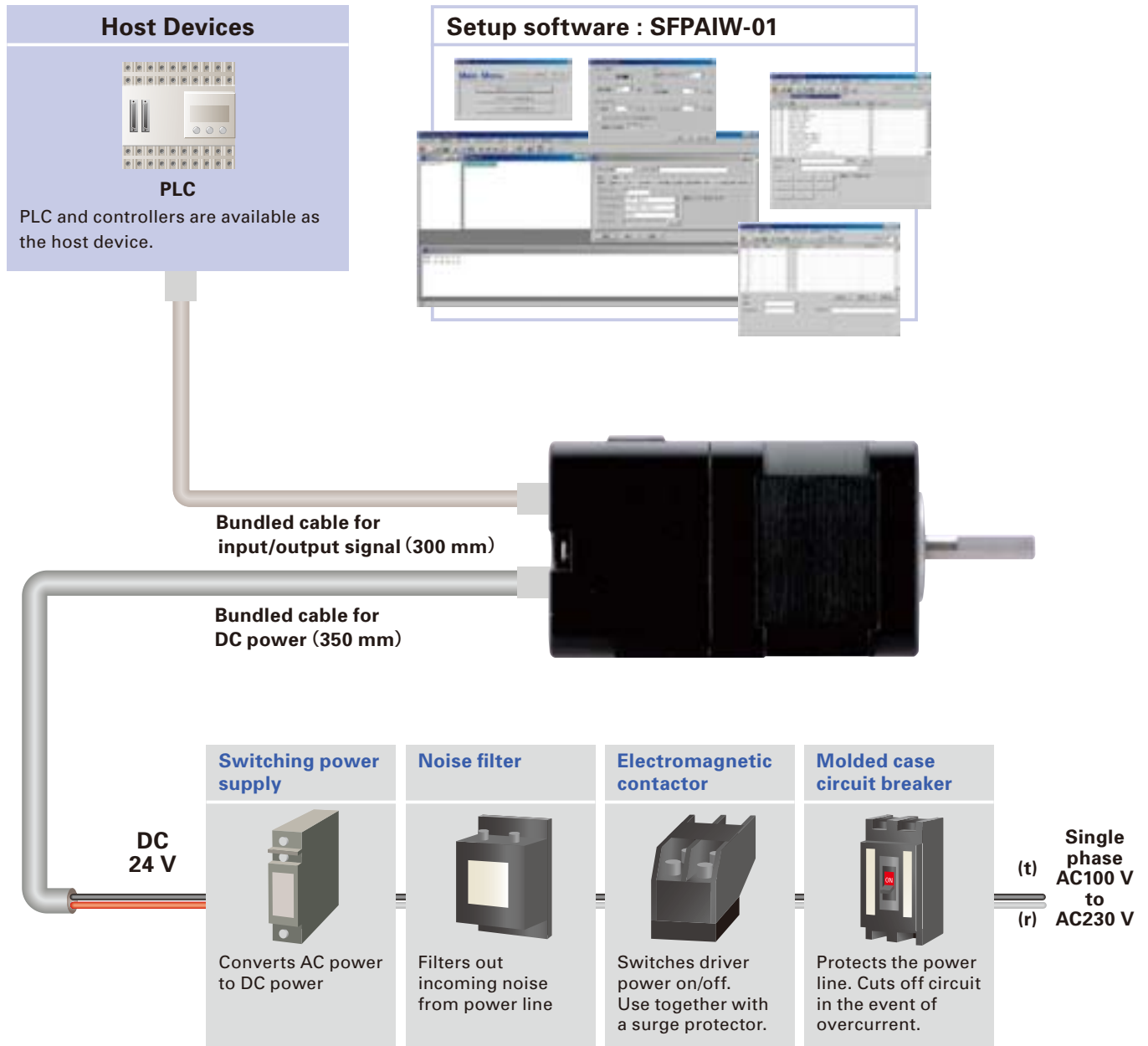

Stepping motors with integrated drivers



Features

1. Driver and motor are now integrated into a single unit.

A driver incorporating a motion control function needed for driving a motor and a 2-phase stepping motor were integrated into a single unit for enabling a more compact installation space and less wiring.

2. Three types of operation modes can be selected to match the specific application.

- (1) Control by command pulses
- (2) Program control by general-purpose I/O(Parallel)
- (3) Compliant with RS-485, half-duplex asynchronous communication

Pulse rate-torque characteristics

42mm (1.65inch)

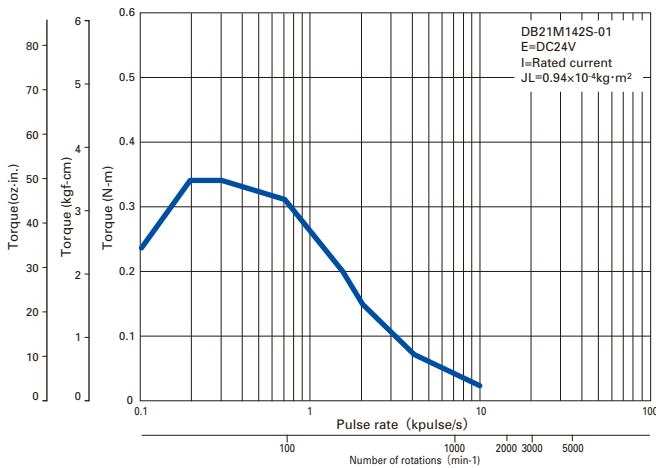

60mm (2.36inch)

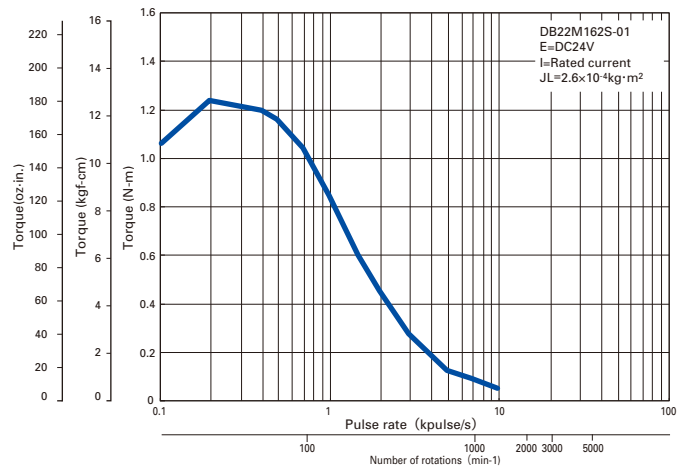

The data are measured under the drive condition of our company. The drive torque may vary depending on the accuracy of customer-side equipment.

Dimensions [Unit : mm (inch)]

42mm (1.65inch)

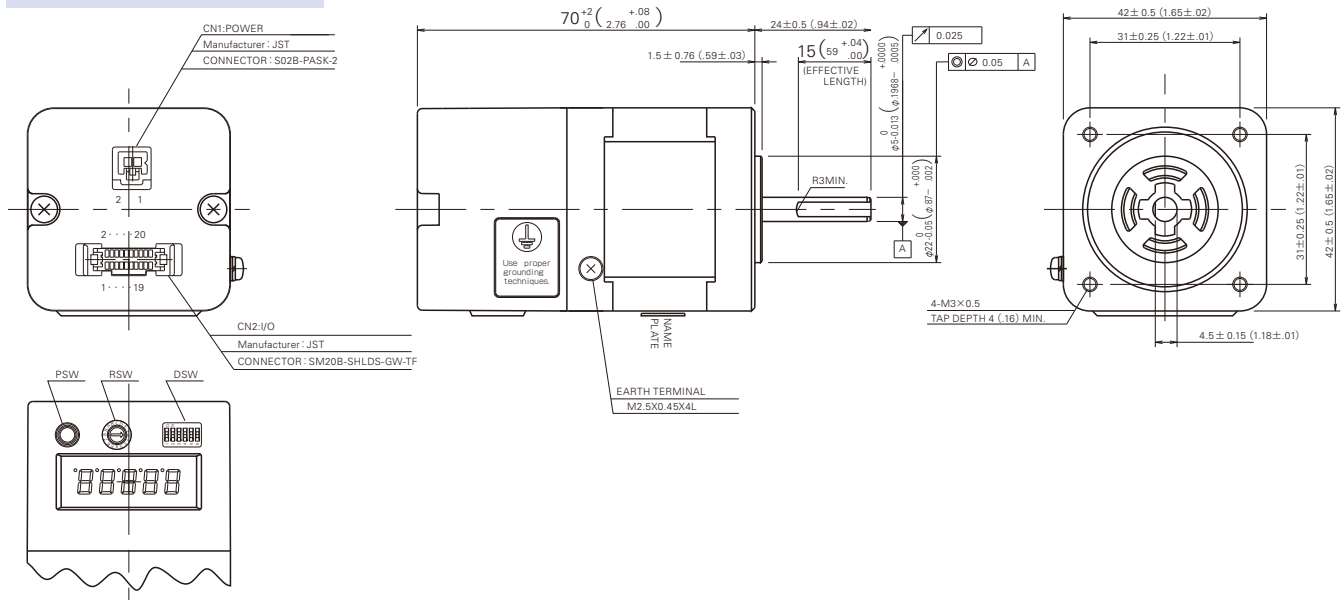

Input circuit configuration

Input interface

Input circuit configuration

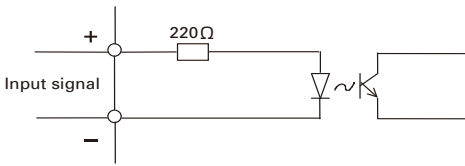

Input signal specifications

Negative logic

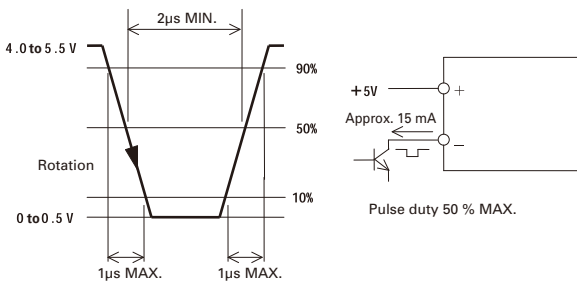

Positive logic

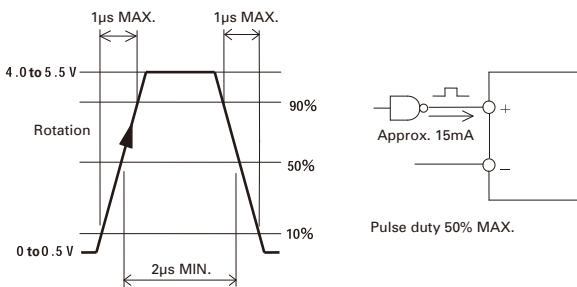

Timing of the command pulse

2-input mode (CW, CCW)

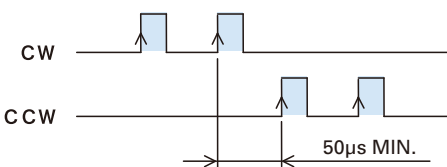

- The internal photo coupler turns ON within the high pulse and, at its falling edge to OFF, the internal circuit (motor) is activated.
- When applying the pulse to CW, turn OFF the CCW side internal photo coupler.
- When applying the pulse to CCW, turn OFF the CW side internal photo coupler.

Pulse and direction mode (CK, U/D)

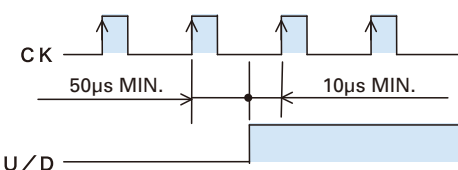

- The "H" level is input for U/D and, at its rising edge to "H" level, the internal circuit (stepping motor) is activated.
- Switching the input signal U/D should be performed while the input level on the CK side is "L" .

Input circuit configuration

Input circuit configuration (PD, EXT, F/H, EMG)

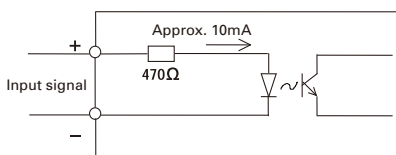

Timing of command pulse, step angle selection, and FULL/HALF selection input signal

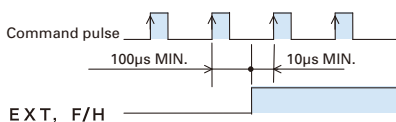

- Shaded area indicates internal photo coupler "ON".
- EXT input signal
EXT photo coupler "ON" enables a function by external F/H input signal.
EXT photo coupler "OFF" enables the setting of a number of micro steps by main unit's rotary switch S.S.
- F/H input signal
F/H photo coupler "ON" sets HALF step (2-division) operation.
F/H photo coupler "OFF" sets FULL step (1-division) operation.
- Refer to switching EXT and F/H input signal in the [FULL/HALF input signal, command pulse, and step angle select].
- When switching the step angle by EXT and F/H input signal, the phase origin LCD may not turn ON and the phase origin monitor output may not output when stop. Refer to the MON output in the [Output Interface].

Output interface

Output circuit configuration (BUSY, MON, AL)

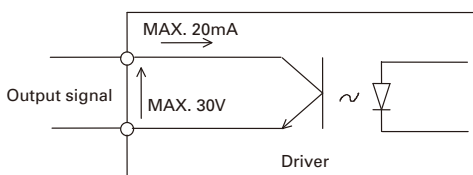

Mon output

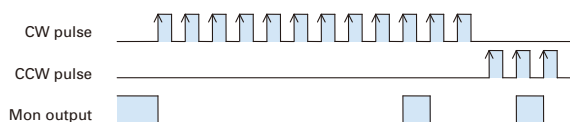

- When the motor excitation phase is at the phase origin (power ON status), the photo coupler is turned "ON", and the upper D.P of status LED turns on synchronously.
- Output from MON is set to on at every 7.2 degrees of motor output shaft from phase origin.

When changing the division setting by F/H input signal.

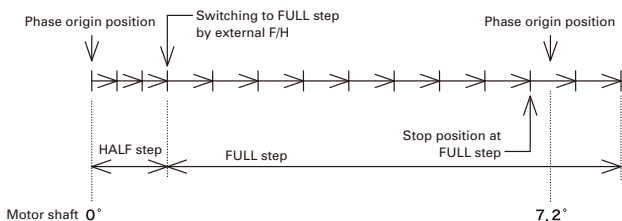

- When changing the motor division setting by the external input signal and the rotary switch as shown in the example below, the motor cannot stop where MON output signal can be output. Take this into consideration when using the MON output signal.

WIRING

Specification Summary of Input/Output Signals (Serial I/F mode)

Signal	Reference Designation	Pin Number	Function Summary
General-purpose input common	+COM	6	Input signal common of the 6 to 9 pins DC5V is input.
Alarm clear signal (standard)	ALMC	6	Recoverable alarms are cleared. Internal photo coupler off → on → Alarm clear
General-purpose input 1	IN1	6	This is a general-purpose input signal that can be used by program driving. Internal photo coupler on → General purpose input 1 on Internal photo coupler off → General purpose input 1 off
Emergency stop input	EMG	6	The emergency stop signal is input. Internal photo coupler on → No emergency stop Internal photo coupler off → Emergency stop
Origin signal	ORG	6	The origin signal used for the return to origin operation is input. Internal photo coupler on → Origin signal on Internal photo coupler off → Origin signal off
+ direction overtravel signal	+OT	7	An overtravel signal in the + direction is input. Internal photo coupler on → + direction overtravel not arrived Internal photo coupler off → + direction overtravel arrived
General-purpose input 2	IN2	7	This is a general-purpose input signal that can be used by program driving. Internal photo coupler on → General purpose input 2 on Internal photo coupler off → General purpose input 2 off
Emergency stop input	EMG	7	The emergency stop signal is input. Internal photo coupler on → No emergency stop Internal photo coupler off → Emergency stop
Origin signal	ORG	7	The origin signal used for the return to origin operation is input. Internal photo coupler on → Origin signal on Internal photo coupler off → Origin signal off
Alarm clear signal	ALMC	7	Recoverable alarms are cleared. Internal photo coupler off → on → Alarm clear
- direction overtravel signal	-OT	8	An overtravel signal in the - direction is input. Internal photo coupler on → - direction overtravel not arrived Internal photo coupler off → - direction overtravel arrived
General-purpose input 3	IN3	8	This is a general-purpose input signal that can be used by program driving. Internal photo coupler on → General purpose input 3 on Internal photo coupler off → General purpose input 3 off
Emergency stop input	EMG	8	emergency stop signal is input. Internal photo coupler on → No emergency stop Internal photo coupler off → Emergency stop
Origin signal	ORG	8	The origin signal used for the return to origin operation is input. Internal photo coupler on → Origin signal on Internal photo coupler off → Origin signal off
Alarm clear signal	ALMC	8	Recoverable alarms are cleared. Internal photo coupler off → on → Alarm clear

Signal	Reference Designation	Pin Number	Function Summary
Emergency stop signal	EMG	9	The emergency stop signal is input. Internal photo coupler on → No emergency stop Internal photo coupler off → Emergency stop
General-purpose input 4c	IN4	9	This is a general-purpose input signal that can be used by program driving. Internal photo coupler on → General purpose input 4 on Internal photo coupler off → General purpose input 4 off
Origin signal	ORG	9	The origin signal used for the return to origin operation is input. Internal photo coupler on → Origin signal on Internal photo coupler off → Origin signal off
Alarm clear signal	ALMC	9	alarms are cleared. Internal photo coupler off → on → Alarm clear
During motor operation	BUSY	10	The operation status of the motor is output. Internal photo coupler on → During motor operation Internal photo coupler off → During motor stop
During program execution	PEND	10	The execution status of the program is output. Internal photo coupler on → During program execution Internal photo coupler off → Program execution complete
Zone signal	ZONE	10	on when the current position is inside the coordinates that were set beforehand.
During program execution	PEND	11	The execution status of the program is output. Internal photo coupler on → During program execution Internal photo coupler off → Program execution complete
During motor operation	BUSY	11	The operation status of the motor is output. Internal photo coupler on → During motor operation Internal photo coupler off → During motor stop
Zone signal	ZONE	11	Turns on when the current position is inside the coordinates that were set beforehand.
Alarm output	ALM	12	When various alarm circuits operate in the driver, an external signal is output. At this time, the stepping motor becomes non excited status.
Output signal common	OUT_COM	13	It is for the output signal common.
DATA+	DATA+	14	It is for the serial signal.
DATA-	DATA-	15	It is for the serial signal.

Specification Summary of Input/Output Signals (Pulse train I/F mode)

Signal	Reference Designation	Pin Number	Function Summary
CW pulse input (Standard)	CW+ CW-	1 2	When "2 input mode", Input drive pulse rotating CW direction.
Pulse train input	CK+ CK-	1 2	When "1 input mode", Input drive pulse train for motor rotation.
CCW pulse input (Standard)	CCW+ CCW-	3 4	When "2 input mode", Input drive pulse rotating CCW direction.
Rotational direction input	U/D+ U/D-	3 4	When "1 input mode", Input motor rotational direction signal. Internal photo coupler ON → CW direction Internal photo coupler OFF → CCW direction
General-purpose input common	+COM	6	Input signal common of the 6 to 9 pins DC5V is input.
Power down input	PD	6	Inputting PD signal will cut off (power off) the current flowing to the Motor (With dip switch select, change to the Power low function is possible). PD input signal on (internal photo coupler on) → PD function is valid. PD input signal off (internal photo coupler off) → PD function is invalid.
Step angle select input	EXT	7	FULL/HALF select input will become valid by inputting EXT signal. EXT input signal on (internal photo coupler on) → External input signal F/H is valid EXT input signal off (internal photo coupler off) → Main body rotary switch S.S is valid

Signal	Reference Designation	Pin Number	Function Summary
FULL/HALF select input	F/H	8	When EXT input signal on (internal photo coupler on), F/H input signal on (internal photo coupler on) → HALF step F/H input signal off (internal photo coupler off) → FULL step
Emergency stop	EMG	9	The emergency stop signal is input. Internal photo coupler on → No emergency stop Internal photo coupler off → Emergency stop
During motor operation	BUSY	10	The operation status of the motor is output. Internal photo coupler on → During motor operation Internal photo coupler off → During motor stop
Phase origin monitor output	MON	11	When the excitation phase is at the origin (in power on) it turns on. When FULL step, ON once for 4 pulses, when HALF step, ON once for 8 pulses.
Alarm output	ALM	12	When alarm circuits actuated inside the Driver, outputs signals to outside. Then the Stepping motor becomes unexcited status.
Output signal common	OUT_COM	13	It is for the output signal common.

*As for the Motor rotational direction, CW direction is regarded as the clockwise revolution by viewing the Motor from output shaft side.

Specification Summary of Input/Output Signals (Parallel I/F mode)

Signal	Reference Designation	Pin Number	Function Summary
Program drive Start/Stop	START+ START-	1 2	Commands the start and stop of program driving. Internal photo coupler on...Program driving start Internal photo coupler off...Program driving stop
Program pause	PAUSE+ PAUSE-	3 4	When START signal on, a pause in program driving is commanded. Internal photo coupler on...Program driving pause Internal photo coupler off...Program driving pause release
General-purpose input common	+COM	6	Input signal common of the 6 to 9 pins DC5V is input.
Alarm clear signal (standard)	ALMC	6	Recoverable alarms are cleared. Internal photo coupler off → on...Alarm clear
General-purpose input 1	IN1	6	This is a general-purpose input signal that can be used by program driving. Internal photo coupler on...General purpose input 1 on Internal photo coupler off...General purpose input 1 off
Program number selection bit 1	B1	6	The program number is selected along with other bits. (Subordinate bit) Internal photo coupler on...Corresponding bit 1 Internal photo coupler off...Corresponding bit 0
Emergency stop input	EMG	6	The emergency stop signal is input. Internal photo coupler on...No emergency stop Internal photo coupler off...Emergency stop
Origin signal	ORG	6	The origin signal used for the return to origin operation is input. Internal photo coupler on...Origin signal on Internal photo coupler off...Origin signal off
+ direction overtravel signal	+OT	7	An overtravel signal in the + direction is input. Internal photo coupler on...+ direction overtravel not arrived Internal photo coupler off...+ direction overtravel arrived
General-purpose input 2	IN2	7	This is a general-purpose input signal that can be used by program driving. Internal photo coupler on...General purpose input 2 on Internal photo coupler off...General purpose input 2 off
Program number selection bit 2	B2	7	The program number is selected along with other bits. (The second bit from the subordinate) Internal photo coupler on...Corresponding bit 1 Internal photo coupler off...Corresponding bit 0
Emergency stop input	EMG	7	The emergency stop signal is input. Internal photo coupler on...No emergency stop Internal photo coupler off...Emergency stop
Origin signal	ORG	7	The origin signal used for the return to origin operation is input. Internal photo coupler on...Origin signal on Internal photo coupler off...Origin signal off
Alarm clear signal	ALMC	7	Recoverable alarms are cleared. Internal photo coupler off → on...Alarm clear
- direction overtravel signal	-OT	8	An overtravel signal in the - direction is input. Internal photo coupler on...- direction overtravel not arrived Internal photo coupler off...- direction overtravel arrived
General-purpose input 3	IN3	8	This is a general-purpose input signal that can be used by program driving. Internal photo coupler on...General purpose input 3 on Internal photo coupler off...General purpose input 3 off
Program number selection bit 4	B4	8	The program number is selected along with other bits. (The third bit from the subordinate) Internal photo coupler on...Corresponding bit 1 Internal photo coupler off...Corresponding bit 0
Emergency stop input	EMG	8	The emergency stop signal is input. Internal photo coupler on...No emergency stop Internal photo coupler off...Emergency stop
Origin signal	ORG	8	The origin signal used for the return to origin operation is input. Internal photo coupler on...Origin signal on Internal photo coupler off...Origin signal off
Alarm clear signal	ALMC	8	Recoverable alarms are cleared. Internal photo coupler off → on...Alarm clear

Signal	Reference Designation	Pin Number	Function Summary
Emergency stop signal	EMG	9	The emergency stop signal is input. Internal photo coupler on...No emergency stop Internal photo coupler off...Emergency stop
General-purpose input 4	IN4	9	This is a general-purpose input signal that can be used by program driving. Internal photo coupler on...General purpose input 4 on Internal photo coupler off...General purpose input 4 off
Program number selection bit 8	B8	9	The program number is selected along with other bits. (The fourth bit from the subordinate) Internal photo coupler on...Corresponding bit 1 Internal photo coupler off...Corresponding bit 0
Origin signal	ORG	9	The origin signal used for the return to origin operation is input. Internal photo coupler on...Origin signal on Internal photo coupler off...Origin signal off
Alarm clear signal	ALMC	9	Recoverable alarms are cleared. Internal photo coupler off → on...Alarm clear
During motor operation	BUSY	10	The operation status of the motor is output. Internal photo coupler on...During motor operation Internal photo coupler off...During motor stop
During program execution	PEND	10	The execution status of the program is output. Internal photo coupler on...During program execution Internal photo coupler off...Program execution complete
Zone signal	ZONE	10	Turns on when the current position is inside the coordinates that were set beforehand.
During program execution	PEND	11	The execution status of the program is output. Internal photo coupler on...During program execution Internal photo coupler off...Program execution complete
During motor operation	BUSY	11	The operation status of the motor is output. Internal photo coupler on...During motor operation Internal photo coupler off...During motor stop
Zone signal	ZONE	11	Turns on when the current position is inside the coordinates that were set beforehand.
Alarm output	ALM	12	When various alarm circuits operate in the driver, an external signal is output. At this time, the stepping motor becomes non excited status.
Output signal common	OUT_COM	13	It is for the output signal common.
DATA+	DATA+	14	It is for the serial signal.
DATA-	DATA-	15	It is for the serial signal.

External Wiring Diagrams

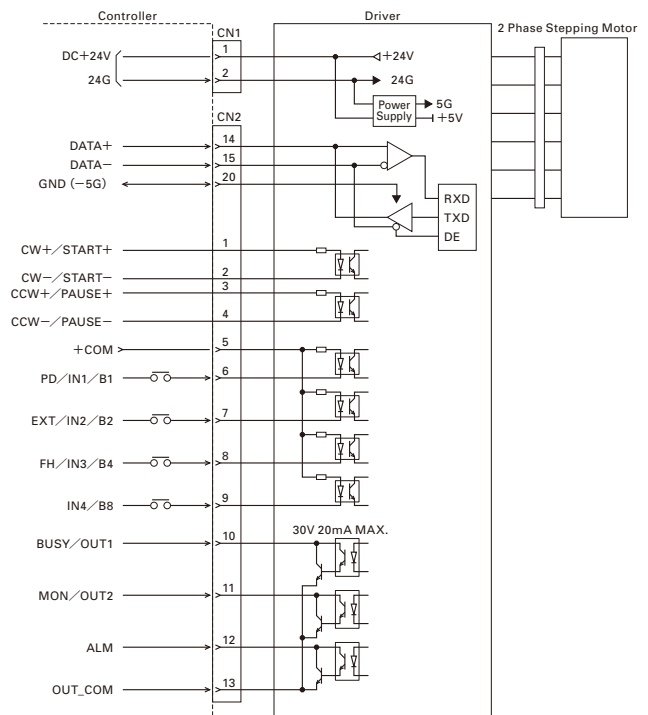

SET UP

Function Select Dip Switch

The functions according to the specification can be selected with this Dip switch.
Confirm the ex-factory setting as follows.

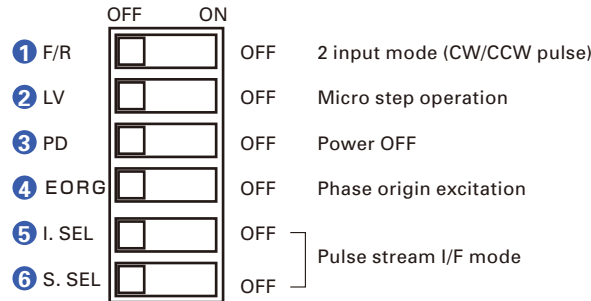

For pulse stream I/F mode

1 Input mode select (F/R)

Input pulse mode selection

This switch setting is only effective in pulse stream I/F mode.

F/R	Input pulse mode
ON	1 input mode (CK,U/D)
OFF	2 input mode (CW,CCW)

2 Low vibration mode select (LV)

Low vibration and smooth operation is enabled even by the rough resolution setting (e.g. 1 division, 2 division) .

This switch setting is only effective in pulse stream I/F mode.

For parallel I/F mode and serial I/F mode, this is usually a low vibration operation.

LV	Operation
ON	Low vibration operation
OFF	Micro step operation

*When LV select is ON (low vibration mode) , operational process of driving pulse will be carried out inside the Driver. Therefore, the Motor movement delays for the time of 3.2ms pulse per input pulse. Note that depending upon the combined Motor, load,driving profile and etc, it may take a while until the shaft is adjusted when the Motor stops. (In parallel I/F mode and serial I/F mode there is no delay)

3 Power down select (PD)

Select the Motor winding current value when inputting the power down signal.This switch setting is only effective in pulse stream I/F mode.

PD	Motor winding current
ON	Current value by rotary switch STP (Power Low)
OFF	0A (Power OFF)

*PD function (the setting selected by PD of the function select dip switch) is enabled by PD input signal ON (built-in photo coupler ON) of Input/ Output signal connector (CN2) . Power down signal input is prior to all the other current settings except for alarms. The operational status may not be maintained such as power swing due to output torque drop or lower operation due to Motor current OFF (unexcited Motor) . Pay extra attention to the input timing of the power down signal in addition that the security device should be installed to the machine.

4 Excitation select (EORG)

*By turning on the EORG, excitation phase when power OFF is saved.

5, 6 Operation mode selection (I.SEL, S.SEL)

The operation mode is selected.

I.SEL	S.SEL	Operation mode
OFF	—	Pulse stream I/F mode
ON	OFF	Parallel I/F mode
	ON	Serial I/F mode

*Change the operation mode selection switch after cutting off the driver's power supply.

For parallel I/F mode or serial I/F mode

The communication speed of serial communication is set.

Switch	Set value	Communication speed(bps)		
		9,600	19,200	38,400
F/R	OFF	○	○	○
	ON			
LV	OFF	○	○	
	ON			○
PD	OFF	○		○
	ON		○	

*The setting change after the power supply is turned on is invalid. It does not function as a F/R, LV, and PD.

*The communication speed of pulse stream I/F mode is fixed at 9600bps.

■ Rotary switch(RSW) and the mode change switch(PSW)

◎ For pulse stream I/F mode

When it selects the step angle, the driving current is selected, and stops the current is selected, set by combining rotary switch (RSW) and mode change switch (PSW).

1. Step angle select(S.S)

The divisions of the basic step angle (0.9° /step) when micro step driving can be set.

Gradation	0	1	2	3	4	5	6	7
Partition	1	2	2.5	4	5	8	10	20
Gradation	8	9	A	B	C	D	E	F
Partition	25	40	50	80	100	125	200	250

Ex-factory setting is at 1 (division 2)

*The step angle select switch (S.S) and the number of partitions become invalid by EXT input signal ON (built-in photo coupler ON) of Input/Output signal connector (CN2).

2. Driving current select(RUN)

The Motor operation current value can be selected.

Gradation	0	1	2	3	4	5	6	7
Motor current (%)	100 (rated)	95	90	85	80	75	70	65
Gradation	8	9	A	B	C	D	E	F
Motor current (%)	60	55	50	45	40	35	30	25

Ex-factory setting is at 0 (rated value).

*When there is a sufficient extra motor torque, lowering the operation current value will be effective in the lower vibration. The Motor output torque is almost proportional to the current value. When adjusting the operational torque, confirm the sufficient operation margin and determine the Motor current value.

3. Current Select when Stop (STP)

The motor current value when stop and when power down input signal ON (power low function is selected by dip switch) can be selected.

Gradation	0	1	2	3	4	5	6	7
Motor current (%)	100 (rated)	95	90	85	80	75	70	65
Gradation	8	9	A	B	C	D	E	F
Motor current (%)	60	55	50	45	40	35	30	25

Ex-factory setting is set at A (50%).

*The current setting when stop by STP becomes valid when the Motor stops (approximately 200ms after the last pulse input) and when power down input signal

◎ For parallel I/F mode and serial I/F mode

The slave bureau address of serial communications can be set.

RSW	Slave station address (HEX)
0	0
1	1
:	:
E	E
F	F

Ex-factory setting is set at 0

*The slave station address of the pulse stream I/F mode is fixed at 0.

Unipolar standard

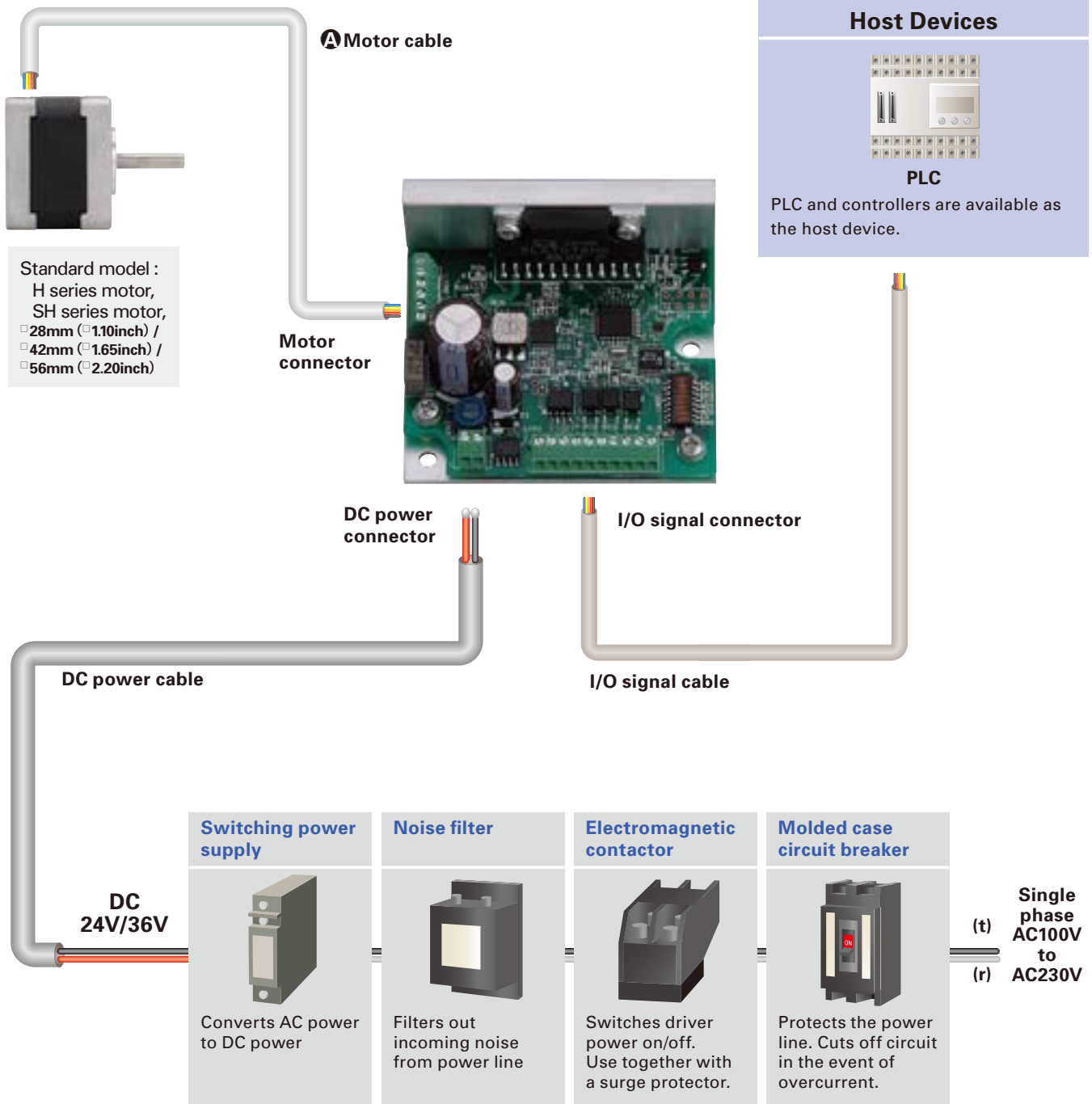

■ Bundled cable (□ 42mm motors only)

⊙ Motor cable
□ 42mm (□ 1.65inch)

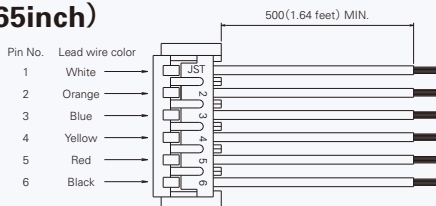

Lead wire	UL1430 AWG26
Housing	HER-6 BLACK (J.S.T Mfg.Co.,Ltd)
Pin	SEH-001T-P0.6 (J.S.T Mfg.Co.,Ltd)

Bipolar standard

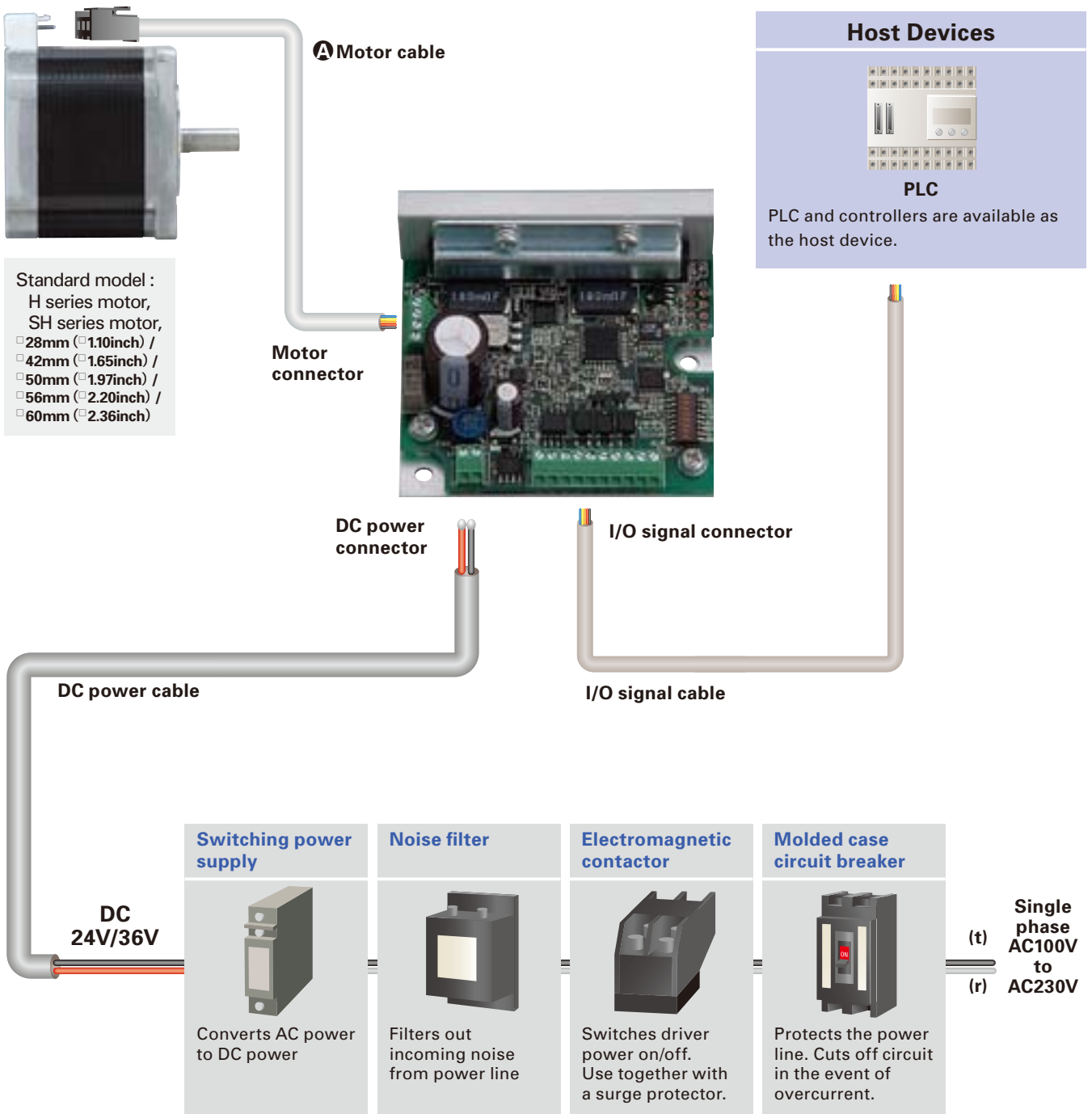

■ Bundled cable (□ 42mm motors only)

Ⓐ Motor cable

□ 42mm (□ 1.65inch)

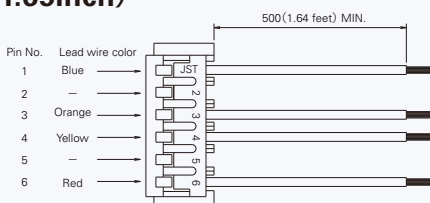

Lead wire	UL1430 AWG26
Housing	HER-6 BLACK (J.S.T Mfg.Co.,Ltd)
Pin	SEH-001T-P0.6 (J.S.T Mfg.Co.,Ltd)

□ 60mm (□ 2.36inch)

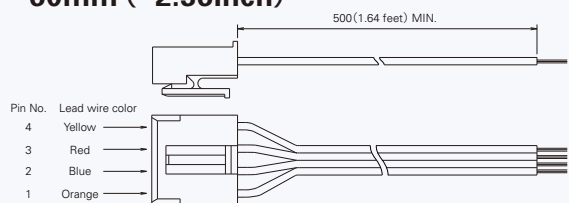

Lead wire	UL1430 AWG22
Housing	VER-4N (J.S.T Mfg.Co.,Ltd)
Pin	SVH-21T-P1.1 (J.S.T Mfg.Co.,Ltd)

Stepping Motors with Internal drivers

Set model

Stepping motor

Dimensions

IC for stepping motor

Part numbering convention

The following set part number specifies a system with an F series unipolar driver (type code : US1D200P10) and a single shaft H series motor (type code : 103H7121-0440) , □56 mm (□2.20 inch) square flange, and 41.8 mm (1.65 inch) motor length.

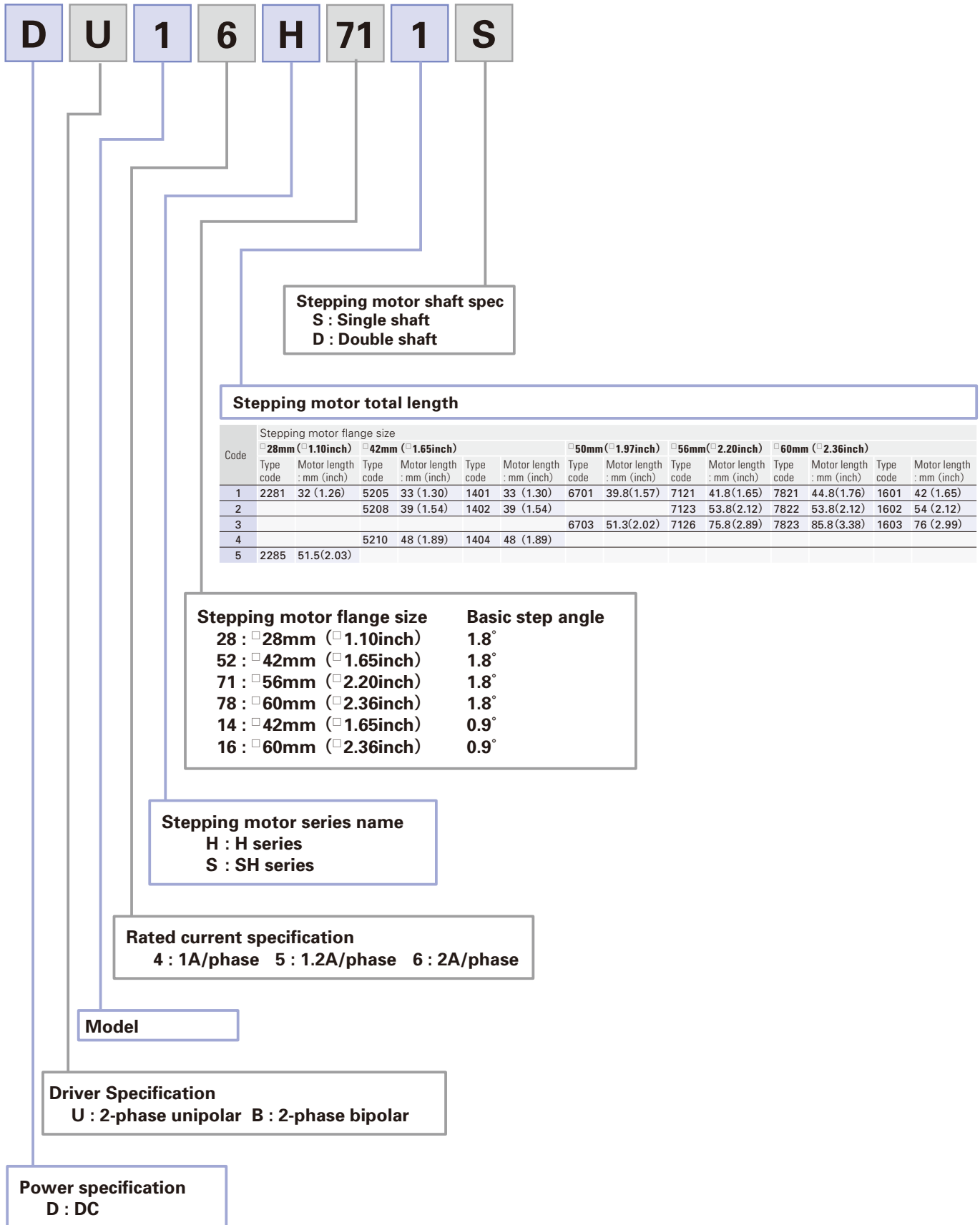

Combination list of 2-phase unipolar driver

System type	Motor flange size	Basic step angle	Set part number		Motor model number		Rated current
			Single shaft	Double shaft	Single shaft	Double shaft	
Standard model	□ 28mm (□ 1.10inch)	1.8°	DU14S281S	DU14S281D	SH2281-5271	SH2281-5231	1A
		1.8°	DU14S285S	DU14S285D	SH2285-5271	SH2285-5231	1A
	□ 42mm (□ 1.65inch)	1.8°	DU15H521S	DU15H521D	103H5205-0440	103H5205-0410	1.2A
		1.8°	DU15H522S	DU15H522D	103H5208-0440	103H5208-0410	1.2A
		1.8°	DU15H524S	DU15H524D	103H5210-0440	103H5210-0410	1.2A
		0.9°	DU15S141S	DU15S141D	SH1421-0441	SH1421-0411	1.2A
		0.9°	DU15S142S	DU15S142D	SH1422-0441	SH1422-0411	1.2A
		0.9°	DU15S144S	DU15S144D	SH1424-0441	SH1424-0411	1.2A
	□ 56mm (□ 2.20inch)	1.8°	DU16H711S	DU16H711D	103H7121-0440	103H7121-0410	2A
		1.8°	DU16H713S	DU16H713D	103H7123-0440	103H7123-0410	2A
		1.8°	DU16H716S	DU16H716D	103H7126-0440	103H7126-0410	2A

Combination list of 2-phase bipolar driver

System type	Motor flange size	Basic step angle	Set part number		Motor model number		Rated current
			Single shaft	Double shaft	Single shaft	Double shaft	
Standard model	□ 28mm (□ 1.10inch)	1.8°	DB14S281S	DB14S281D	SH2281-5771	SH2281-5731	1A
		1.8°	DB14S285S	DB14S285D	SH2285-5771	SH2285-5731	1A
	□ 42mm (□ 1.65inch)	1.8°	DB14H521S	DB14H521D	103H5205-5240	103H5205-5210	1A
		1.8°	DB14H522S	DB14H522D	103H5208-5240	103H5208-5210	1A
		1.8°	DB14H524S	DB14H524D	103H5210-5240	103H5210-5210	1A
		0.9°	DB16S141S	DB16S141D	SH1421-5241	SH1421-5211	2A
		0.9°	DB16S142S	DB16S142D	SH1422-5241	SH1422-5211	2A
		0.9°	DB16S144S	DB16S144D	SH1424-5241	SH1424-5211	2A
	□ 50mm (□ 1.97inch)	1.8°	DB16H671S	DB16H671D	103H6701-5040	103H6701-5010	2A
		1.8°	DB16H672S	DB16H672D	103H6703-5040	103H6703-5010	2A
	□ 56mm (□ 2.20inch)	1.8°	DB16H711S	DB16H711D	103H7121-5740	103H7121-5710	2A
		1.8°	DB16H713S	DB16H713D	103H7123-5740	103H7123-5710	2A
	□ 60mm (□ 2.36inch)	1.8°	DB16H716S	DB16H716D	103H7126-5740	103H7126-5710	2A
		1.8°	DB16H781S	DB16H781D	103H7821-5740	103H7821-5710	2A
		1.8°	DB16H782S	DB16H782D	103H7822-5740	103H7822-5710	2A
		1.8°	DB16H783S	DB16H783D	103H7823-5740	103H7823-5710	2A
		0.9°	DB16S161S	DB16S161D	SH1601-5240	SH1601-5210	2A
		0.9°	DB16S162S	DB16S162D	SH1602-5240	SH1602-5210	2A
		0.9°	DB16S163S	DB16S163D	SH1603-5240	SH1603-5210	2A

Standard model

F series driver + H or SH series motor
Unipolar

Motor flange size



Size	Motor flange size	□28mm (1.10inch) /1.8°	
	Motor length	32mm (1.26inch)	51.5mm (2.03inch)
Set part number	Single shaft	DU14S281S	DU14S285S
	Double shaft	DU14S281D	DU14S285D
Holding torque	N·m(oz·in)	0.055 (7.79)	0.115 (16.28)
Rotor inertia	×10 ⁻⁴ kg·m ² (oz·in ²)	0.01 (0.05)	0.022 (0.12)
Mass (Weight)	kg (lbs)	0.11 (0.24)	0.2 (0.44)
Allowable thrust load	N (lbs)	3 (0.67)	3 (0.67)
Allowable radial load (Note1)	N (lbs)	42 (9.44)	49 (11.02)

(Note1) When load is applied at 1/3 length from output shaft edge.



DC24V

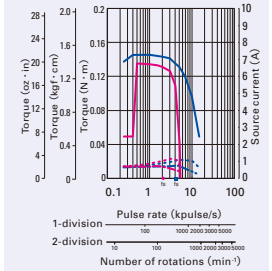
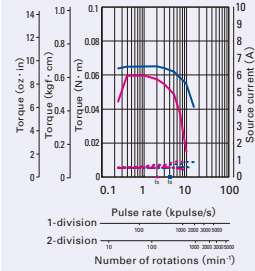

DC36V

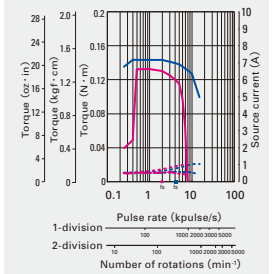
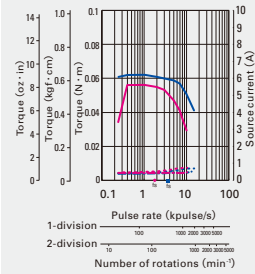

Operating current: 1A/phase

- Pull-out torque
- Source current (load applied)
- Source current (no load)
- 1-division fs
- 2-division fs
- Fs: Maximum self-start frequency when not loaded

The data are measured under the drive condition of our company. The drive torque may very depending on the accuracy of customer-side equipment.

Size	Motor flange size	□42mm(1.65inch)/0.9°		
	Motor length	33mm (1.30inch)	39mm (1.54inch)	48mm (1.89inch)
Set part number	Single shaft	DU15S141S	DU15S142S	DU15S144S
	Double shaft	DU15S141D	DU15S142D	DU15S144D
Holding torque	N·m(oz·in)	0.2 (28.32)	0.29 (41.07)	0.39 (55.23)
Rotor inertia	×10 ⁻⁴ kg·m ² (oz·in ²)	0.044 (0.24)	0.066 (0.361)	0.089 (0.487)
Mass (Weight)	kg (lbs)	0.24 (0.53)	0.29 (0.64)	0.38 (0.84)
Allowable thrust load	N (lbs)	10 (2.25)	10 (2.25)	10 (2.25)
Allowable radial load (Note1)	N (lbs)	30 (6)	30 (6)	30 (6)

(Note1) When load is applied at 1/3 length from output shaft edge.

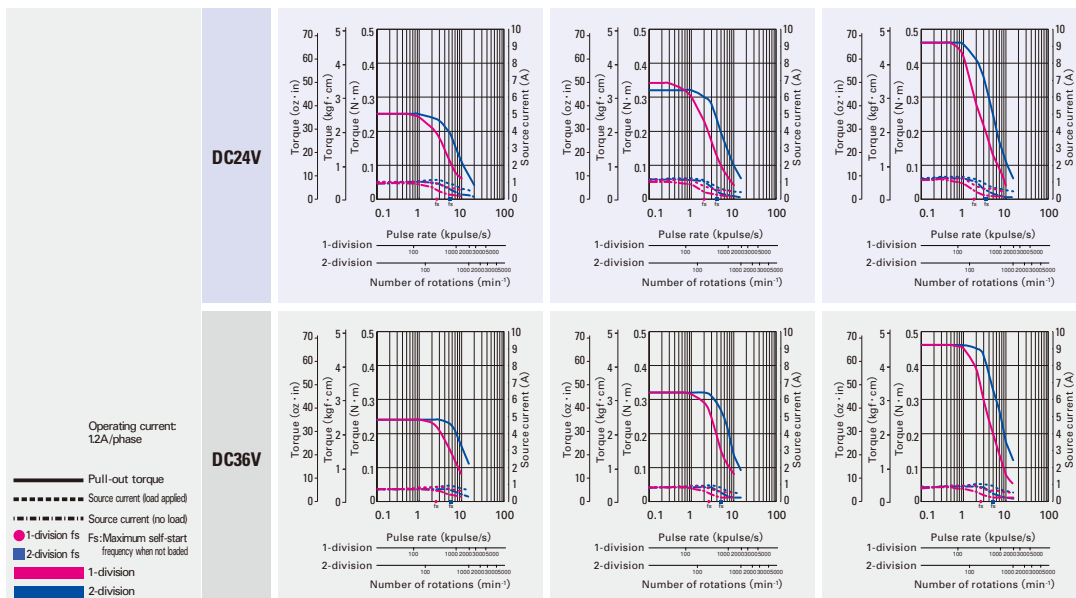

Operating current: 1.2A/phase

- Pull-out torque
- Source current (load applied)
- Source current (no load)
- 1-division fs
- 2-division fs
- Fs: Maximum self-start frequency when not loaded

The data are measured under the drive condition of our company. The drive torque may very depending on the accuracy of customer-side equipment.

Size	Motor flange size	□ 42mm (1.65inch) /1.8°		
	Motor length	33mm (1.30inch)	39mm (1.54inch)	48mm (1.89inch)
Set part number	Single shaft	DU15H521S	DU15H522S	DU15H524S
	Double shaft	DU15H521D	DU15H522D	DU15H524D
Holding torque	N·m(oz·in)	0.2 (28.32)	0.3 (42.48)	0.37 (52.39)
Rotor inertia	×10 ⁻⁴ kg·m ² (oz·in ²)	0.036 (0.20)	0.056 (0.31)	0.072 (0.34)
Mass (Weight)	kg (lbs)	0.23 (0.51)	0.29 (0.64)	0.37 (0.82)
Allowable thrust load	N (lbs)	10 (2.25)	10 (2.25)	10 (2.25)
Allowable radial load (Note1)	N (lbs)	30 (6)	30 (6)	30 (6)

(Note1) When load is applied at 1/3 length from output shaft edge.

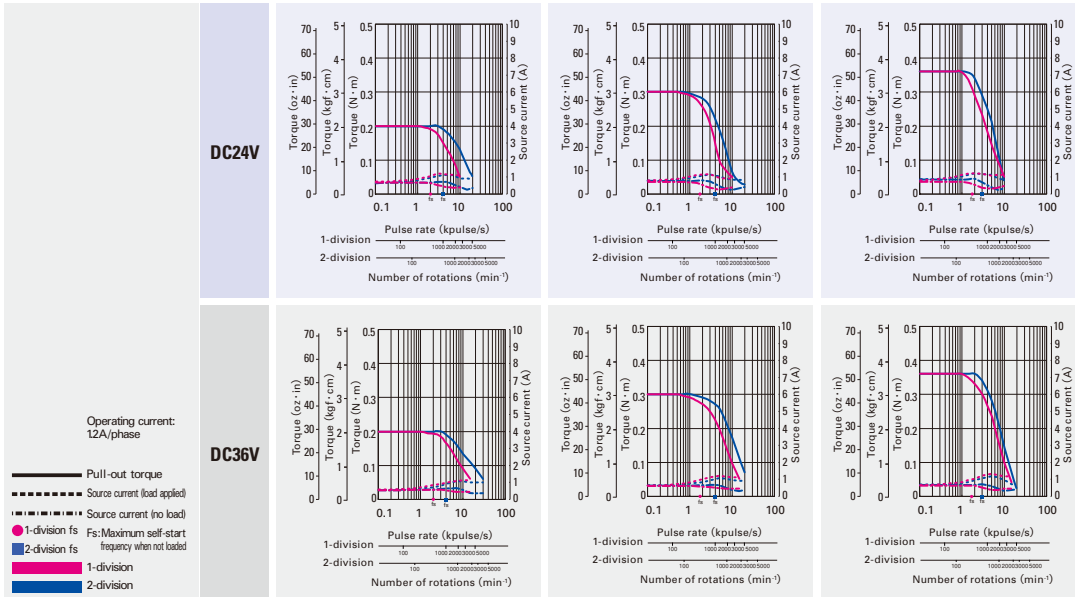

Size	Motor flange size	□ 56mm (2.20inch) /1.8°		
	Motor length	41.8mm (1.65inch)	53.8mm (2.12inch)	75.8mm (2.98inch)
Set part number	Single shaft	DU16H711S	DU16H713S	DU16H716S
	Double shaft	DU16H711D	DU16H713D	DU16H716D
Holding torque	N·m(oz·in)	0.39 (55.23)	0.83 (117.5)	1.27 (179.8)
Rotor inertia	×10 ⁻⁴ kg·m ² (oz·in ²)	0.1 (0.55)	0.21 (1.15)	0.36 (1.97)
Mass (Weight)	kg (lbs)	0.47 (1.04)	0.63 (1.39)	0.98 (2.16)
Allowable thrust load	N (lbs)	15 (3.37)	15 (3.37)	15 (3.37)
Allowable radial load (Note1)	N (lbs)	71 (15)	71 (15)	71 (15)

(Note1) When load is applied at 1/3 length from output shaft edge.

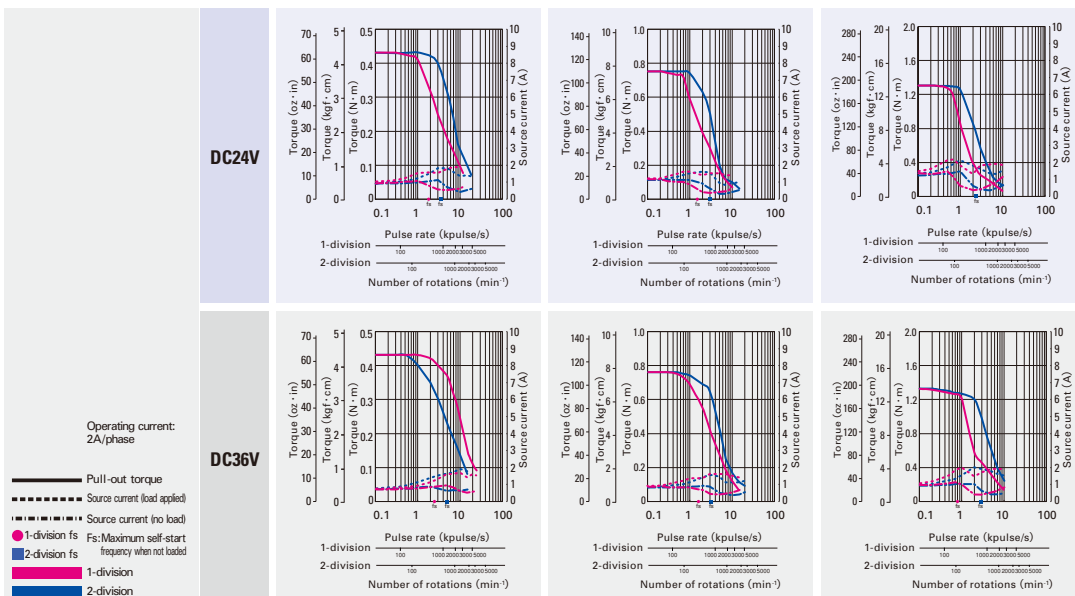

Standard model

F series driver + H or SH series motor
Bipolar

Motor flange size



Size	Motor flange size	□28mm (1.10inch) /1.8°	
	Motor length	32mm (1.26inch)	51.5mm (2.03inch)
Set part number	Single shaft	DB14S281S	DB14S285S
	Double shaft	DB14S281D	DB14S285D
Holding torque	N·m(oz·in)	0.07 (9.91)	0.145 (20.53)
Rotor inertia	×10 ⁻⁴ kg·m ² (oz·in ²)	0.01 (0.05)	0.022 (0.12)
Mass (Weight)	kg (lbs)	0.11 (0.24)	0.2 (0.44)
Allowable thrust load	N (lbs)	3 (0.67)	3 (0.67)
Allowable radial load ^(Note1)	N (lbs)	42 (9.44)	49 (9.44)

(Note1) When load is applied at 1/3 length from output shaft edge.



DC24V

DC36V

Operating current
 □28mm (1.10inch)/1.8° :1A/phase
 □42mm (1.65inch)/1.8° :1A/phase
 □42mm (1.65inch)/0.9° :2A/phase

— Pull-out torque
 - - - Source current (load applied)
 - - - Source current (no load)
 ● 1-division fs Fs:Maximum self-start frequency when not loaded
 ■ 2-division fs
 ■ 1-division
 ■ 2-division

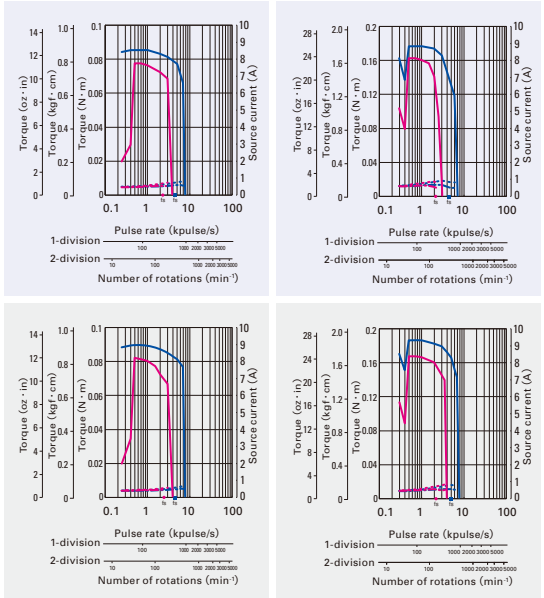

The data are measured under the drive condition of our company. The drive torque may vary depending on the accuracy of customer-side equipment.

Size	Motor flange size	□42mm (1.65inch) /0.9°	□50mm (1.97inch) /1.8°	□51.3mm (2.02inch)	□56mm (2.20inch) /1.8°
	Motor length	48mm (1.89inch)	39.8mm (1.57inch)	51.3mm (2.02inch)	41.8mm (1.65inch)
Set part number	Single shaft	DB16S144S	DB16H671S	DB16H673S	DB16H711S
	Double shaft	DB16S144D	DB16H671D	DB16H673D	DB16H711D
Holding torque	N·m(oz·in)	0.48 (67.97)	0.28 (39.6)	0.49 (69.4)	0.39 (55.2)
Rotor inertia	×10 ⁻⁴ kg·m ² (oz·in ²)	0.089 (0.487)	0.057 (0.31)	0.118 (0.65)	0.1 (0.55)
Mass (Weight)	kg (lbs)	0.38 (0.84)	0.35 (0.77)	0.5 (1.10)	0.47 (1.04)
Allowable thrust load	N (lbs)	10 (2.25)	15 (3.37)	15 (3.37)	15 (3.37)
Allowable radial load ^(Note1)	N (lbs)	30 (6)	99 (22)	99 (22)	71 (15)

(Note1) When load is applied at 1/3 length from output shaft edge.

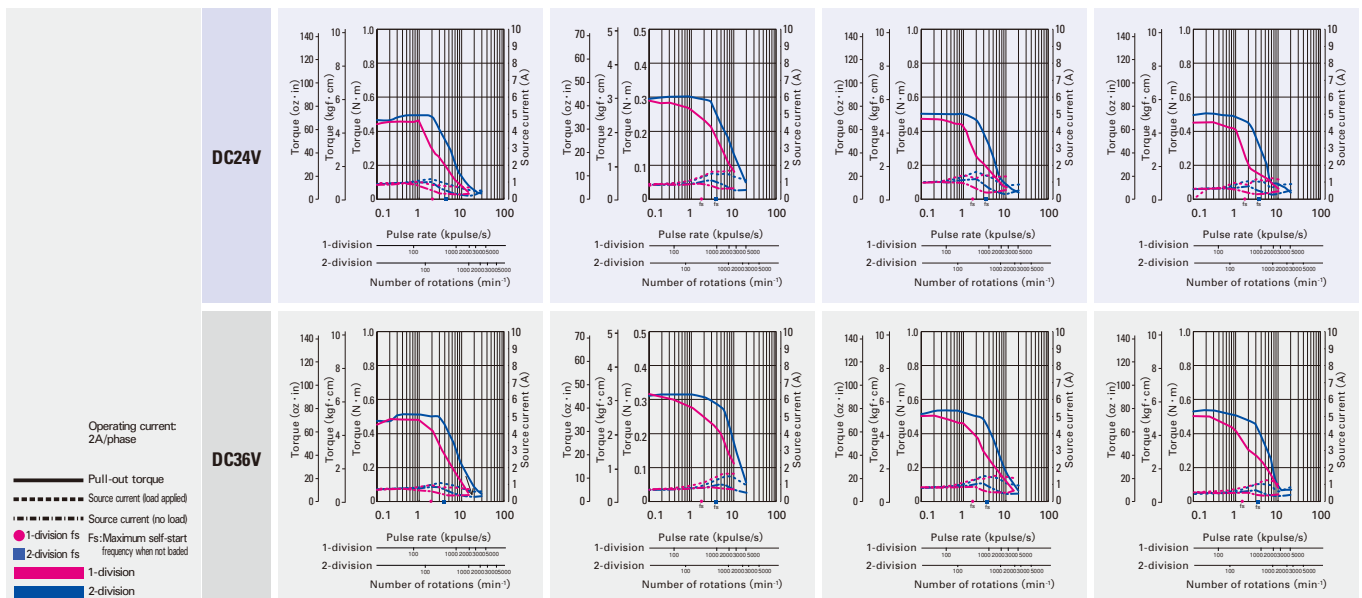

The data are measured under the drive condition of our company. The drive torque may vary depending on the accuracy of customer-side equipment.

□ 42mm (1.65inch) /1.8°

33mm (1.30inch)	39mm (1.54inch)	48mm (1.89inch)
DB14H521S	DB14H522S	DB14H524S
DB14H521D	DB14H522D	DB14H524D
0.265 (37.53)	0.39 (55.23)	0.51 (72.22)
0.036 (0.20)	0.056 (0.31)	0.072 (0.34)
0.23 (0.51)	0.29 (0.64)	0.37 (0.82)
10 (2.25)	10 (2.25)	10 (2.25)
30 (6)	30 (6)	30 (6)

□ 42mm (1.65inch) /0.9°

33mm (1.30inch)	39mm (1.54inch)
DB16S141S	DB16S142S
DB16S141D	DB16S142D
0.23 (32.57)	0.34 (48.15)
0.044 (0.24)	0.066 (0.361)
0.24 (0.53)	0.29 (0.64)
10 (2.25)	10 (2.25)
30 (6)	30 (6)

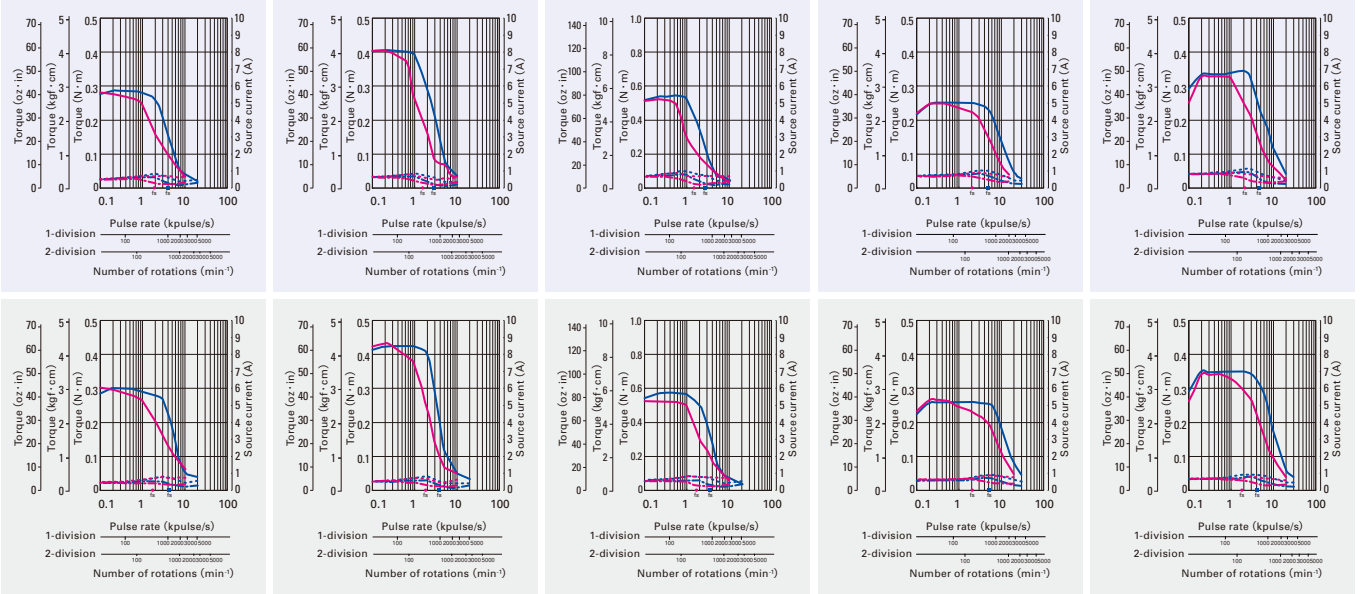

□ 56mm (2.20inch) /1.8°

53.8mm (2.12inch)	75.8mm (2.98inch)
DB16H713S	DB16H716S
DB16H713D	DB16H716D
0.83 (117.5)	1.27 (179.8)
0.21 (1.15)	0.36 (1.97)
0.65 (1.43)	0.98 (2.16)
15 (3.37)	15 (3.37)
71 (15)	71 (15)

□ 60mm (2.36inch) /1.8°

44.8mm (1.76inch)	53.8mm (2.12inch)	85.8mm (3.38inch)
DB16H781S	DB16H782S	DB16H783S
DB16H781D	DB16H782D	DB16H783D
0.88 (124.6)	1.37 (194.0)	2.7 (382.3)
0.275 (1.50)	0.4 (2.19)	0.84 (4.59)
0.6 (1.32)	0.77 (1.70)	1.34 (2.95)
15 (3.37)	15 (3.37)	15 (3.37)
95 (21)	95 (21)	95 (21)

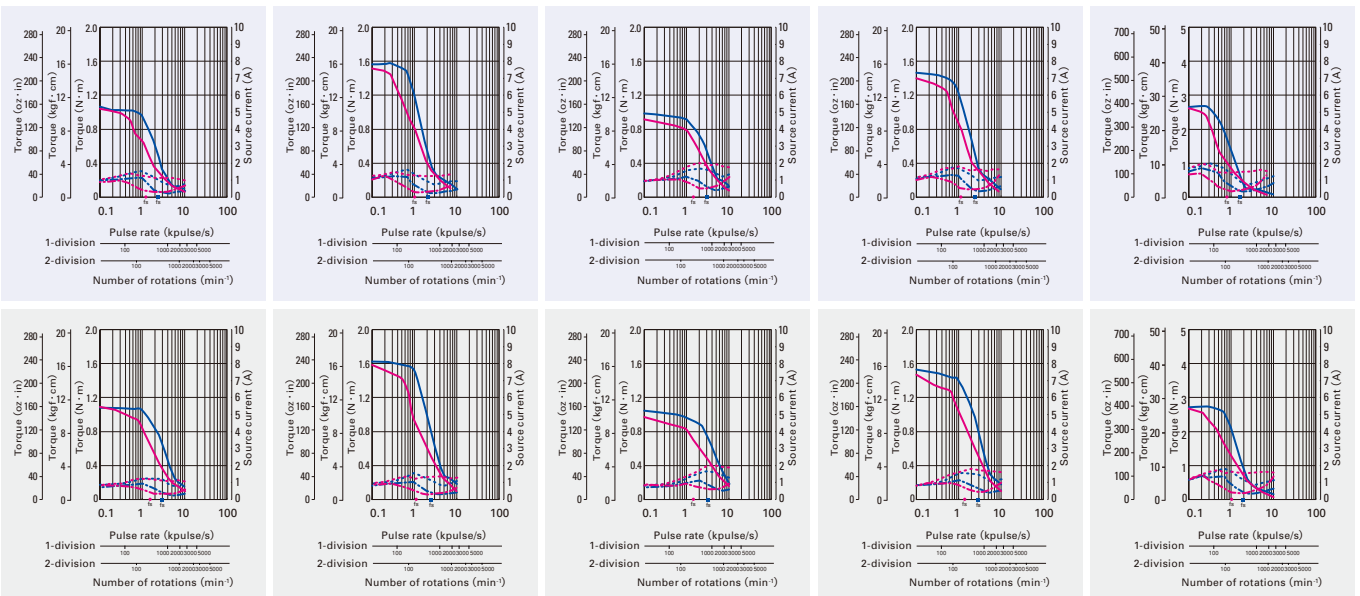

DC input Specifications

Size	Motor flange size	□ 60mm (2.36inch) /0.9°	
	Motor length	42mm (16.54inch)	54mm (21.26inch)
Set part number	Single shaft	DB16S161S	DB16S162S
	Double shaft	DB16S161D	DB16S162D
Holding torque	N·m(oz·in)	0.69 (97.71)	1.28 (181.26)
Rotor inertia	×10 ⁻⁴ kg·m ² (oz·in ²)	0.24 (1.312)	0.4 (2.187)
Mass (Weight)	kg (lbs)	0.55 (1.21)	0.8 (1.76)
Allowable thrust load	N (lbs)	15 (3.37)	15 (3.37)
Allowable radial load ^(Note1)	N (lbs)	79 (18)	79 (18)

(Note1) When load is applied at 1/3 length from output shaft edge.

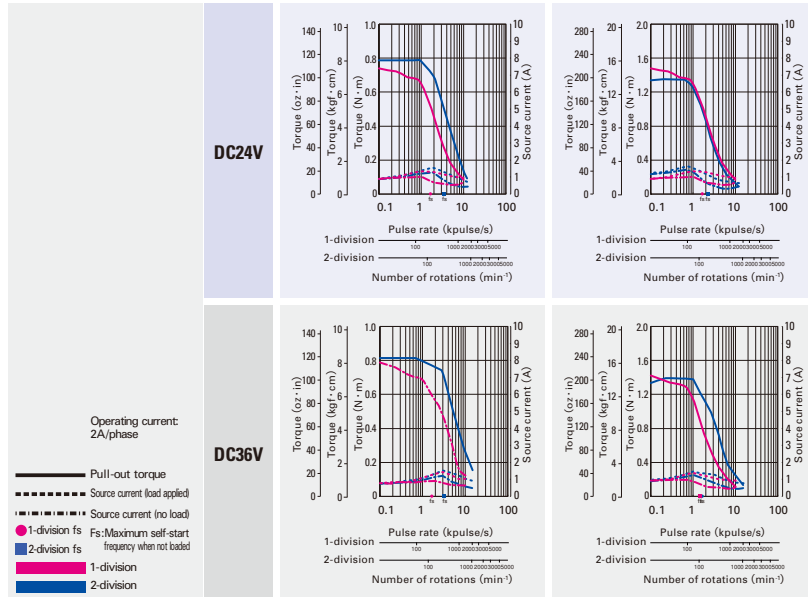

The data are measured under the drive condition of our company.
The drive torque may vary depending on the accuracy of customer-side equipment.

Specifications of Drivers

■ Unipolar

Model number		US1D200P10		
Basic specifications	Input source	DC24 V/36 V ± 10 %		
	Source current	3 A		
	Environment	Protection class	Class III	
		Operation environment	Installation category (over-voltage category) : I, pollution degree : 2	
		Applied standards	EN61010-1, UL508C	
		Ambient operation temperature	0 to +50°C	
		Conservation temperature	-20 to +70°C	
		Operating ambient humidity	35 to 85% RH (no condensation)	
		Conservation humidity	10 to 90% RH (no condensation)	
		Operation altitude	2000 m (6560 feet) or less above sea level	
		Vibration resistance	Tested under the following conditions; 4.9 m/s ² , frequency range 10 to 55Hz, direction along X, Y and Z axes, for 2 hours each	
		Impact resistance	Not influenced at NDS-C-0110 standard section 3.2.2 division "C" .	
		Withstand voltage	Not influenced when 1500 V AC is applied between power input terminal and cabinet for one minute.	
		Insulation resistance	10 M Ω MIN. when measured with 500V DC megohmmeter between input terminal and cabinet.	
Mass (Weight)	0.08 kg (0.18 lbs)			
Functions	Selection functions	Step angle, Pulse input mode, Step current, Operating current.		
	Protection functions	Open phase protection, Main circuit power source voltage decrease		
	LED indication	Power monitor, alarm		
I/O signals	Command pulse input signal	Photo-coupler input system, input resistance : 220 Ω input-signal "H" level : 4.0 to 5.5 V, input-signal "L" level : 0 to 0.5 V Maximum input frequency : 150 kpulse/s		
	Power down input signal	Photo-coupler input system, input resistance : 220 Ω input-signal "H" level : 4.0 to 5.5V, input-signal "L" level : 0 to 0.5 V		
	Phase origin monitor output signal	From the photo coupler by the open collector output Output specification : Vceo = 40 V MAX., Ic = 10 mA MAX.		
	Rotation monitor output signal	From the photo coupler by the open collector output Output specification : Vceo = 40 V MAX., Ic = 10 mA MAX.		

■ Bipolar

Model number		BS1D200P10		
Basic specifications	Input source	DC24 V/36 V ± 10 %		
	Source current	3 A		
	Environment	Protection class	Class III	
		Operation environment	Installation category (over-voltage category) : I, pollution degree : 2	
		Applied standards	EN61010-1, UL508C	
		Ambient operation temperature	0 to +50°C	
		Conservation temperature	-20 to +70°C	
		Operating ambient humidity	35 to 85% RH (no condensation)	
		Conservation humidity	10 to 90% RH (no condensation)	
		Operation altitude	2000 m (6560 feet) or less above sea level	
		Vibration resistance	Tested under the following conditions; 4.9m/s ² , frequency range 10 to 55Hz, direction along X, Y and Z axes, for 2 hours each	
		Impact resistance	Not influenced at NDS-C-0110 standard section 3.2.2 division "C" .	
		Withstand voltage	Not influenced when 1500 V AC is applied between power input terminal and cabinet for one minute.	
		Insulation resistance	10 M Ω MIN. when measured with 500 V DC megohmmeter between input terminal and cabinet.	
Mass (Weight)	0.08 kg (0.18 lbs)			
Functions	Selection functions	Step angle, Pulse input mode, Step current, Operating current.		
	Protection functions	Open phase protection, Main circuit power source voltage decrease		
	LED indication	Open phase protection, Power monitor, alarm		
I/O signals	Command pulse input signal	Photo-coupler input system, input resistance : 220 Ω input-signal "H" level : 4.0 to 5.5 V, input-signal "L" level : 0 to 0.5 V Maximum input frequency : 150 kpulse/s		
	Power down input signal	Photo-coupler input system, input resistance : 220 Ω input-signal "H" level : 4.0 to 5.5V, input-signal "L" level : 0 to 0.5 V		
	Phase origin monitor output signal	From the photo coupler by the open collector output Output specification : Vceo = 40 V MAX., Ic = 10 mA MAX.		
	Rotation monitor output signal	From the photo coupler by the open collector output Output specification : Vceo = 40 V MAX., Ic = 10 mA MAX.		

Operation, Connection, and Function

Each section name of the drivers

Unipolar

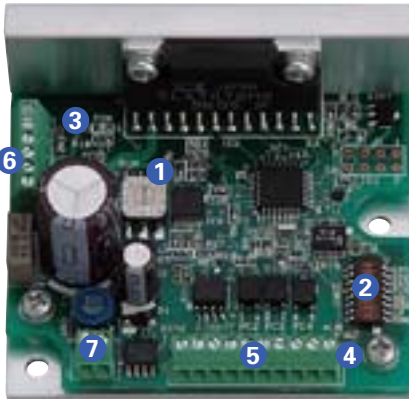

1 Driving current selection switch (RUN)

You can select the value of the motor current when driving.

Dial	0	1	2	3	4	5	6	7
Stepping motor current (A)	2.0	1.9	1.8	1.7	1.6	1.5	1.4	1.3
Dial	8	9	A	B	C	D	E	F
Stepping motor current (A)	1.2	1.1	1.0	0.9	0.8	0.7	0.6	0.5

The factory setting is F (0.5A).
Select the current after checking the rated current of the combination motor.

2 Function selection DIP switchpack

Select the function depending on your specification.

3 LED for power supply monitor (POW)

Lit up when the main circuit power supply is connected.

Indicator	Explanation
"POW" is displayed.	Main circuit power supply is switched on.

4 LED for alarm display (ALM)

Lit when an alarm is generated.

Indicator	Explanation
"ALM" is displayed.	Motor cable is broken, or switching element in driver is faulty. The main circuit voltage is out of specifications range (Less than DC19V).

When "ALM" is displayed, the winding current of the stepping motor is cut off and it is in a "non-excitation" state. At the same time, an output signal is transmitted from the alarm output terminal (AL) to an external source. When the alarm circuit is operating, this state is maintained until it is reset by switching on the power supply again. When an alarm condition has occurred, please take corrective actions to rectify the cause of the alarm before switching on the power supply again.

5 I/O signal connector (CN1)

Connect the I/O signal.

6 Motor connector (CN2)

Connect the motor's power line.

7 Power supply connector (CN3)

Connect the main circuit power supply.

Bipolar

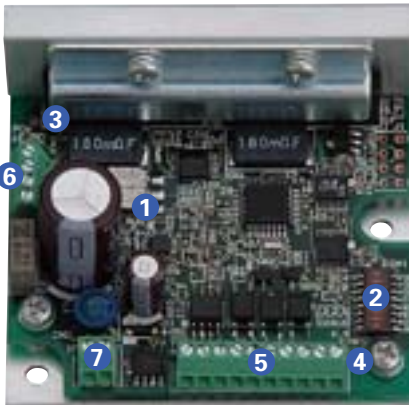

1 Driving current selection switch (RUN)

You can select the value of the motor current when driving.

Dial	0	1	2	3	4	5	6	7
Stepping motor current (A)	2.0	1.9	1.8	1.7	1.6	1.5	1.4	1.3
Dial	8	9	A	B	C	D	E	F
Stepping motor current (A)	1.2	1.1	1.0	0.9	0.8	0.7	0.6	0.5

The factory setting is F (0.5A).
Select the current after checking the rated current of the combination motor.

2 Function selection DIP switchpack

Select the function depending on your specification.

3 LED for power supply monitor (POW)

Lit up when the main circuit power supply is connected.

Indicator	Explanation
"POW" is displayed.	Main circuit power supply is switched on.

4 LED for alarm display (ALM)

Lit when an alarm is generated.

Indicator	Explanation
"ALM" is displayed.	Motor cable is broken, or switching element in driver is faulty. The main circuit voltage is out of specifications range (Less than DC19V).

When "ALM" is displayed, the winding current of the stepping motor is cut off and it is in a "non-excitation" state. At the same time, an output signal is transmitted from the alarm output terminal (AL) to an external source. When the alarm circuit is operating, this state is maintained until it is reset by switching on the power supply again. When an alarm condition has occurred, please take corrective actions to rectify the cause of the alarm before switching on the power supply again.

5 I/O signal connector (CN1)

Connect the I/O signal.

6 Motor connector (CN2)

Connect the motor's power line.

7 Power supply connector (CN3)

Connect the main circuit power supply.

Specification summary of CN1 I/O signal

Signal name	CN1 Pin number	Function
CW pulse input (standard)	1	When using "2-input mode" Drive pulse for the CW direction rotation is input.
	2	Drive pulse train for the stepping motor rotation is input.
Pulse column input	1	When using "Pulse and direction mode" Drive pulse train for the stepping motor rotation is input.
	2	Drive pulse train for the stepping motor rotation is input.
CCW pulse input (standard)	3	When using "2-input mode" Drive pulse for the CCW direction rotation is input.
	4	Drive pulse for the CCW direction rotation is input.
Rotation direction input	3	The rotation direction signal of stepping motor is input for the "Pulse and direction mode".
	4	Internal photocoupler ON...CW direction Internal photocoupler OFF...CCW direction
Power down input	5	Inputting the PD signal cuts OFF the current flowing through the stepping motor.
	6	Internal photocoupler ON...PD function enabled Internal photocoupler OFF...PD function disabled
Phase origin monitor output	7	It is turned ON when the excitation phase is at the origin (in the state when the power is turned ON)
	8	It is turned ON once per 4 pulses when setting to HALF step. It is turned ON once per 8 pulses when setting to FULL step.
Alarm output	9	The signal is externally output when one of several alarm circuits operates in the PM driver. At this time, the stepping motor is in the unexcited state.
	10	

The CW rotation direction of stepping motor means the clockwise direction rotation as viewed from the output shaft side (flange side). The CCW rotation direction means the counterclockwise direction rotation as viewed from the output shaft side (flange side).

② Input circuit configuration (CW and CCW Pulse input)

Functions can be selected according to the specification with the dip switch.

Check that the ex-factory settings are as follows.

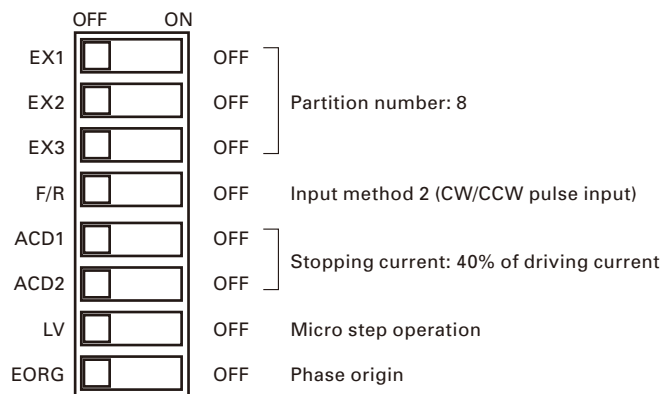

Step angle select (EX1, EX2, EX3)

Select the partition number of the basic step angle.

EX1	EX2	EX3	Partition number
ON	ON	ON	1-division
OFF	ON	OFF	2-division
ON	OFF	OFF	4-division
OFF	OFF	OFF	8-division
OFF	OFF	ON	16-division

Input method select (F/R)

Selects input pulse type

F/R	Input pulse type
ON	1 input (Pulse&direction)
OFF	2 input (CW, CCW)

Current selection when stopping (ACD1, ACD2)

Select the current value of the motor when stopping.

ACD2	ACD1	Current value of the motor
ON	ON	100% of driving current
ON	OFF	60% of driving current
OFF	ON	50% of driving current
OFF	OFF	40% of driving current

Initial configuration of factory shipment is set to 40% of rated value. Driver and motor should be operated at around 50% of rated value to reduce heat.

Low-vibration mode select (LV)

Provides low-vibration, smooth operation even if resolution is rough (1-division, 2-division, etc)

LV	Operation
ON	Auto-micro function
OFF	Micro-step

Excitation select (EORG)

The excitation phase when the power supply is turned on is selected.

EORG	Original excitation phase
ON	Excitation phase at power shut off
OFF	Phase origin

By turning on the EORG, excitation phase when power OFF will be saved. Therefore, there will be no shaft displacement when turning the power ON.

⑤⑥⑦ External wiring diagram

Unipolar

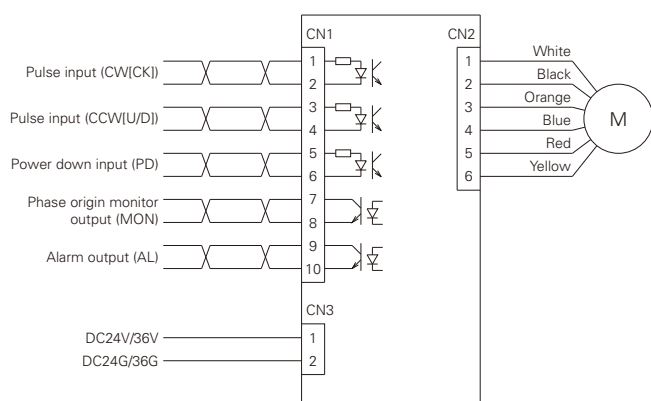

Bipolar

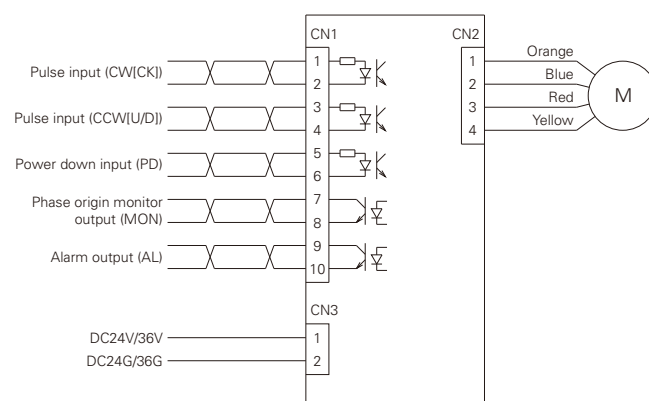

■ Applicable Wire Sizes

Part	Wire size	Allowable wire length
For power supply	AWG22(0.3 mm ²)	2 m MAX.
For input/output signal	AWG24(0.2 mm ²) to AWG22(0.3 mm ²)	2 m MAX.
For motor	AWG22(0.3 mm ²)	3 m MAX.

Input circuit configuration of CW (CK) , CCW (U/D)

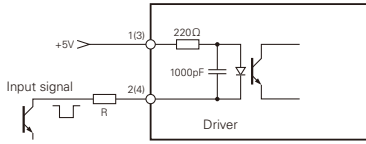

- Pulse duty 50% MAX.
- Maximum input frequency:150kpulse/s
- When the crest value of the input signal exceeds 5V, use the external limit resistance R to limit the input current to approximately 15mA.

Input signal specifications

Photo coupler type

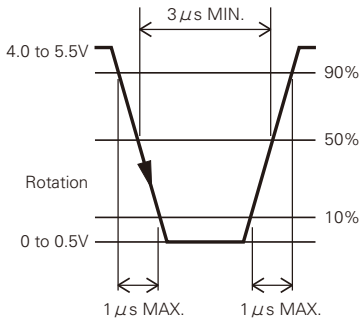

Timing of the command pulse

2-input mode (CW, CCW)

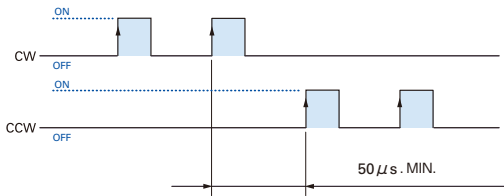

- Shaded area indicates internal photo coupler "ON". Internal circuit (motor) starts operating at leading edge of the photo coupler "ON".
- To apply pulse to CW, set CCW side internal photo coupler to "OFF".
- To apply pulse to CCW, set CW side internal photo coupler to "OFF".

1 input type (CW, CCW)

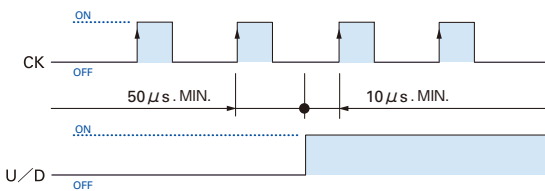

- Shaded area indicates internal photo coupler "ON". Internal circuit (motor) starts operating at leading edge of CK side photo coupler "ON".
- Switching of U/D input signal must be done while CK side internal photo coupler is "OFF".

Input circuit configuration of PD

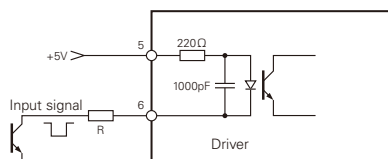

- When the crest value of the input signal exceeds 5V, use the external limit resistance R to limit the input current to approximately 15mA.

Output signal configuration of MON, AL

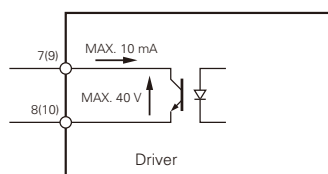

MON output

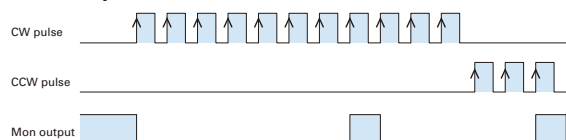

- Photo coupler at phase origin of motor excitation is set to "ON" . (setting when number of divisions is 2)
- Output from MON is set to on at every 7.2 degrees of motor output shaft from phase origin.

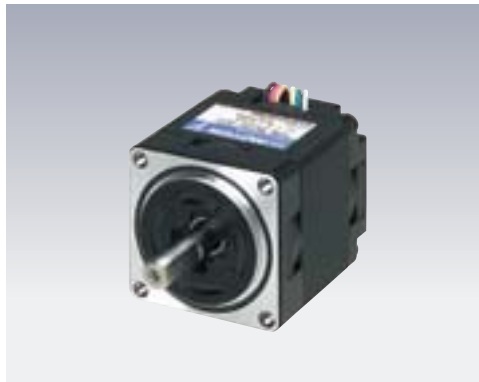

2-phase stepping motor

28mmsq. (1.10inch sq.)

SH228 □
1.8° /step

Unipolar winding • Lead wire type

Model		Holding torque at 2-phase energization	Rated current	Wiring resistance	Winding inductance	Rotor inertia	Mass (Weight)
Single shaft	Double shafts	[N · m (oz · in) MIN.]	A/phase	Ω /phase	mH/phase	[×10 ⁻⁴ kg · m ² (oz · in ²)]	[kg (lbs)]
SH2281-5171	-5131	0.055 (7.79)	0.5	10.5	3.7	0.01 (0.05)	0.11 (0.24)
SH2281-5271	-5231	0.055 (7.79)	1	2.85	1	0.01 (0.05)	0.11 (0.24)
SH2285-5171	-5131	0.115 (16.28)	0.5	16.5	7.1	0.022 (0.12)	0.2 (0.44)
SH2285-5271	-5231	0.115 (16.28)	1	4.1	1.9	0.022 (0.12)	0.2 (0.44)

Pulse rate-torque characteristics

● SH2281-51 □ □

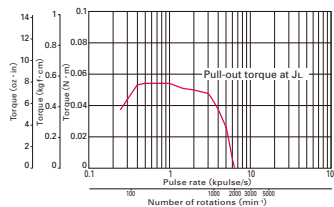

Constant current circuit
Source voltage : DC24V · Operating current : 0.5A/phase,
2-phase energization (full-step)
J_L=[0.01 × 10⁻⁴kg · m² (1.80 oz · in²) pulley balancer method]

● SH2285-51 □ □

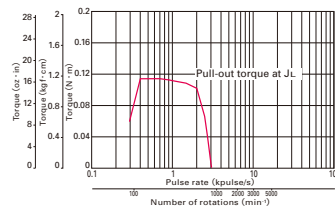

Constant current circuit
Source voltage : DC24V · Operating current : 0.5A/phase,
2-phase energization (full-step)
J_L=[0.01 × 10⁻⁴kg · m² (1.80 oz · in²) pulley balancer method]

● SH2281-52 □ □

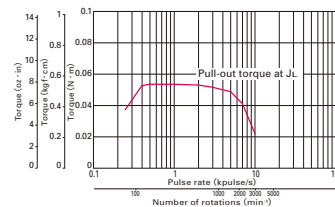

Constant current circuit
Source voltage : DC24V · Operating current : 1A/phase,
2-phase energization (full-step)
J_L=[0.01 × 10⁻⁴kg · m² (1.80 oz · in²) pulley balancer method]

● SH2285-52 □ □

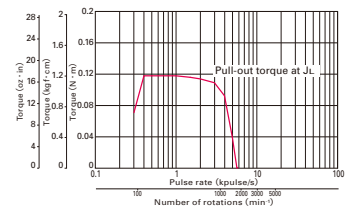

Constant current circuit
Source voltage : DC24V · Operating current : 1A/phase,
2-phase energization (full-step)
J_L=[0.01 × 10⁻⁴kg · m² (1.80 oz · in²) pulley balancer method]

The date are measured under the drive condition of our company. The drive torque may very depending on the accuracy of customer-side equipment.

Bipolar winding • Lead wire type

Model		Holding torque at 2-phase energization	Rated current	Wiring resistance	Winding inductance	Rotor inertia	Mass (Weight)
Single shaft	Double shafts	[N · m (oz · in) MIN.]	A/phase	Ω /phase	mH/phase	[×10 ⁻⁴ kg · m ² (oz · in ²)]	[kg (lbs)]
SH2281-5671	-5631	0.07 (9.91)	0.5	10.5	7.2	0.01 (0.05)	0.11 (0.24)
SH2281-5771	-5731	0.07 (9.91)	1	2.6	1.85	0.01 (0.05)	0.11 (0.24)
SH2285-5671	-5631	0.145 (20.53)	0.5	15	13.5	0.022 (0.12)	0.2 (0.44)
SH2285-5771	-5731	0.145 (20.53)	1	3.75	3.4	0.022 (0.12)	0.2 (0.44)

Pulse rate-torque characteristics

● SH2281-56 □ □

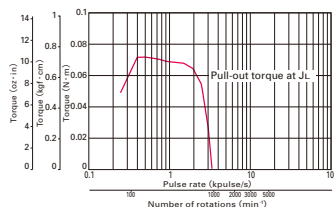

Constant current circuit
Source voltage : DC24V · Operating current : 0.5A/phase,
2-phase energization (full-step)
J_L=[0.01 × 10⁻⁴kg · m² (1.80 oz · in²) pulley balancer method]

● SH2285-56 □ □

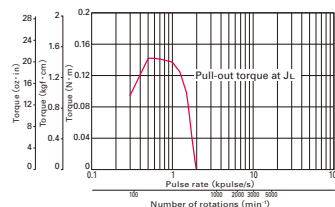

Constant current circuit
Source voltage : DC24V · Operating current : 0.5A/phase,
2-phase energization (full-step)
J_L=[0.01 × 10⁻⁴kg · m² (1.80 oz · in²) pulley balancer method]

● SH2281-57 □ □

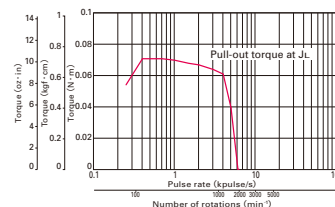

Constant current circuit
Source voltage : DC24V · Operating current : 1A/phase,
2-phase energization (full-step)
J_L=[0.01 × 10⁻⁴kg · m² (1.80 oz · in²) pulley balancer method]

● SH2285-57 □ □

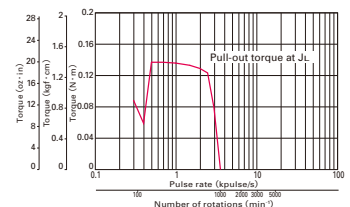

Constant current circuit
Source voltage : DC24V · Operating current : 1A/phase,
2-phase energization (full-step)
J_L=[0.01 × 10⁻⁴kg · m² (1.80 oz · in²) pulley balancer method]

The date are measured under the drive condition of our company. The drive torque may very depending on the accuracy of customer-side equipment.



2-phase stepping motor

35mm sq. (1.38inch sq.)

SH35 □□
1.8° /step

Unipolar winding • Lead wire type

Model		Holding torque at 2-phase energization	Rated current	Wiring resistance	Winding inductance	Rotor inertia	Mass (Weight)
Single shaft	Double shafts	[N · m (oz · in) MIN.]	A/phase	Ω /phase	mH/phase	[$\times 10^{-4}$ kg · m ² (oz · in ²)]	[kg (lbs)]
SH3533-12U40	-12U10	0.12 (16.99)	1.2	2.4	1.3	0.02 (1.09)	0.17 (0.37)
SH3537-12U40	-12U10	0.15 (21.24)	1.2	2.7	2	0.025 (1.37)	0.2 (0.44)
SH3552-12U40	-12U10	0.23 (32.57)	1.2	3.4	2.8	0.043 (2.35)	0.3 (0.66)

Pulse rate-torque characteristics

● SH3533-12U □□

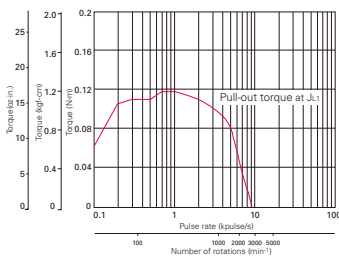

Constant current circuit

Source voltage : DC24V · Operating current : 1.2A/phase,
2-phase energization (full-step)
 $J_{L1}=[0.33 \times 10^{-4}$ kg · m² (1.80 oz · in²) Use the rubber coupling]

● SH3537-12U □□

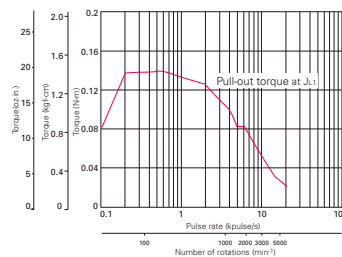

Constant current circuit

Source voltage : DC24V · Operating current : 1.2A/phase,
2-phase energization (full-step)
 $J_{L1}=[0.33 \times 10^{-4}$ kg · m² (1.80 oz · in²) Use the rubber coupling]

● SH3552-12U □□

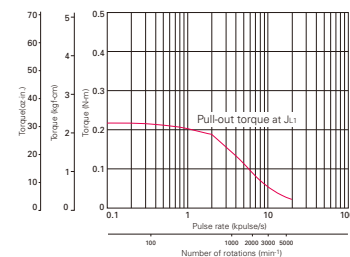

Constant current circuit

Source voltage : DC24V · Operating current : 1.2A/phase,
2-phase energization (full-step)
 $J_{L1}=[0.94 \times 10^{-4}$ kg · m² (5.14 oz · in²) Use the rubber coupling]

The data are measured under the drive condition of our company. The drive torque may vary depending on the accuracy of customer-side equipment.



2-phase stepping motor

42mm sq. (1.65inch sq.)

SS242 □
1.8° / step Bipolar winding

Bipolar winding • Lead wire type

Model		Holding torque at 2-phase energization	Rated current	Wiring resistance	Winding inductance	Rotor inertia	Mass (Weight)
Single shaft	Double shafts	[N · m (oz · in) MIN.]	A/phase	Ω /phase	mH/phase	[×10 ⁻⁴ kg · m ² (oz · in ²)]	[kg (lbs)]
SS2421-5041	-5011	0.083 (11.75)	1	3.5	1.2	0.015 (0.082)	0.07 (0.15)
SS2422-5041	-5011	0.186 (26.33)	1	5.4	2.9	0.028 (0.153)	0.14 (0.31)
SS2423-5041	-5011	0.240 (33.98)	1	7.3	5	0.038 (0.208)	0.20 (0.44)

Pulse rate-torque characteristics

● SS2421-50 □ □

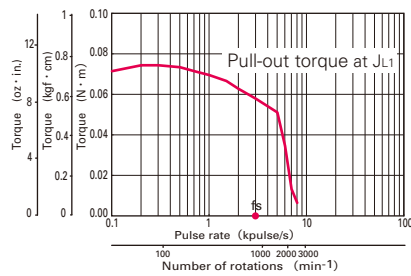

Constant current circuit
Source voltage : DC24V · operating current : 1A/phase,
2-phase energization (full-step)
 $J_{L1} = [0.33 \times 10^{-4} \text{kg} \cdot \text{m}^2 (1.80 \text{oz} \cdot \text{in}^2)]$ inertia of rubber coupling is in cluded
 $J_{L2} = [0.94 \times 10^{-4} \text{kg} \cdot \text{m}^2 (5.14 \text{oz} \cdot \text{in}^2)]$ inertia of rubber coupling is in cluded
fs: No load maximum starting pulse rate

● SS2422-50 □ □

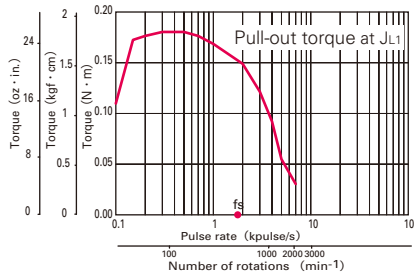

Constant current circuit
Source voltage : DC24V · operating current : 1A/phase,
2-phase energization (full-step)
 $J_{L1} = [0.33 \times 10^{-4} \text{kg} \cdot \text{m}^2 (1.80 \text{oz} \cdot \text{in}^2)]$ inertia of rubber coupling is in cluded
 $J_{L2} = [0.94 \times 10^{-4} \text{kg} \cdot \text{m}^2 (5.14 \text{oz} \cdot \text{in}^2)]$ inertia of rubber coupling is in cluded
fs: No load maximum starting pulse rate

● SS2423-50 □ □

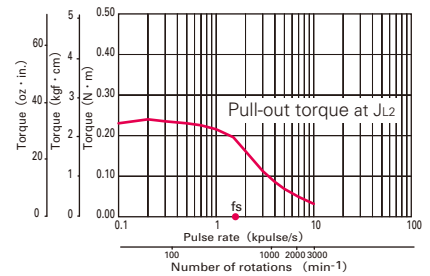

Constant current circuit
Source voltage : DC24V · operating current : 1A/phase,
2-phase energization (full-step)
 $J_{L1} = [0.33 \times 10^{-4} \text{kg} \cdot \text{m}^2 (1.80 \text{oz} \cdot \text{in}^2)]$ inertia of rubber coupling is in cluded
 $J_{L2} = [0.94 \times 10^{-4} \text{kg} \cdot \text{m}^2 (5.14 \text{oz} \cdot \text{in}^2)]$ inertia of rubber coupling is in cluded
fs: No load maximum starting pulse rate

The data are measured under the drive condition of our company. The drive torque may vary depending on the accuracy of customer-side equipment.



2-phase stepping motor

42mm sq. (1.65inch sq.)

SH142 □
0.9° /step

Unipolar winding • Lead wire type

Model		Holding torque at 2-phase energization	Rated current	Wiring resistance	Winding inductance	Rotor inertia	Mass (Weight)
Single shaft	Double shafts	[N · m (oz · in) MIN.]	A/phase	Ω /phase	mH/phase	[×10 ⁻⁴ kg · m ² (oz · in ²)]	[kg (lbs)]
SH1421-0441	-0411	0.20 (28.32)	1.2	2.7	3.2	0.044 (0.241)	0.24 (0.53)
SH1422-0441	-0411	0.29 (41.07)	1.2	3.1	5.3	0.066 (0.361)	0.29 (0.64)
SH1424-0441	-0411	0.39 (55.23)	1.2	3.5	5.3	0.089 (0.487)	0.38 (0.84)

Pulse rate-torque characteristics

● SH1421-04 □ □

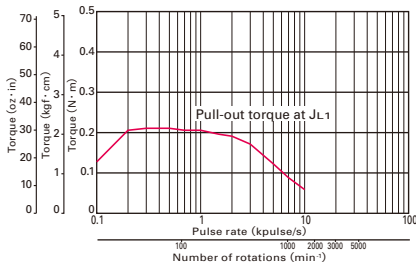

Constant current circuit
Source voltage : DC24V · operating current : 1.2A/phase,
2-phase energization (full-step)
 $J_u = [0.94 \times 10^{-4} \text{kg} \cdot \text{m}^2 (5.14 \text{oz} \cdot \text{in}^2)]$ Use the rubber coupling]

● SH1422-04 □ □

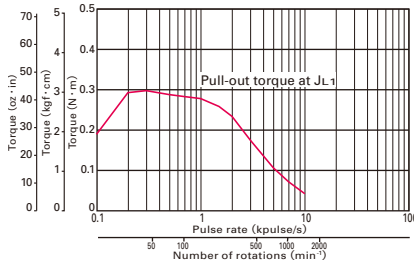

Constant current circuit
Source voltage : DC24V · operating current : 1.2A/phase,
2-phase energization (full-step)
 $J_u = [0.94 \times 10^{-4} \text{kg} \cdot \text{m}^2 (5.14 \text{oz} \cdot \text{in}^2)]$ Use the rubber coupling]

● SH1424-04 □ □

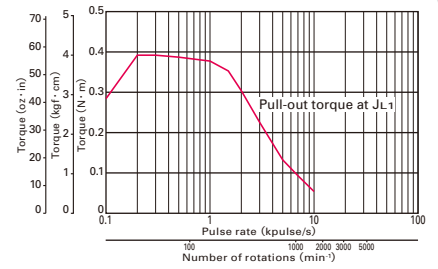

Constant current circuit
Source voltage : DC24V · operating current : 1.2A/phase,
2-phase energization (full-step)
 $J_u = [0.94 \times 10^{-4} \text{kg} \cdot \text{m}^2 (5.14 \text{oz} \cdot \text{in}^2)]$ Use the rubber coupling]

The data are measured under the drive condition of our company. The drive torque may vary depending on the accuracy of customer-side equipment.

Bipolar winding • Lead wire type

Model		Holding torque at 2-phase energization	Rated current	Wiring resistance	Winding inductance	Rotor inertia	Mass (Weight)
Single shaft	Double shafts	[N · m (oz · in) MIN.]	A/phase	Ω /phase	mH/phase	[×10 ⁻⁴ kg · m ² (oz · in ²)]	[kg (lbs)]
SH1421-5041	-5011	0.23 (32.5)	1	3.3	8.0	0.044 (0.24)	0.24 (0.53)
SH1421-5241	-5211	0.23 (32.5)	2	0.85	2.1	0.044 (0.24)	0.24 (0.53)
SH1422-5041	-5011	0.34 (48.1)	1	4.0	14.0	0.066 (0.36)	0.29 (0.64)
SH1422-5241	-5211	0.34 (48.1)	2	1.05	3.6	0.066 (0.36)	0.29 (0.64)
SH1424-5041	-5011	0.48 (67.9)	1	4.7	15.0	0.089 (0.49)	0.38 (0.84)
SH1424-5241	-5211	0.48 (67.9)	2	1.25	3.75	0.089 (0.49)	0.38 (0.84)

Pulse rate-torque characteristics

● SH1421-50 □□

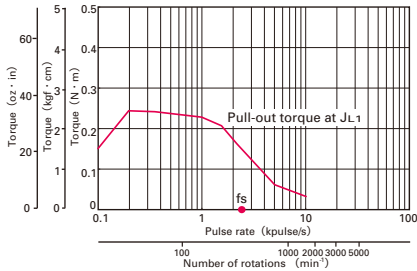

Constant current circuit
 Source voltage : DC24V · operating current : 2A/phase,
 2-phase energization (full-step)
 $J_{L1} = [0.94 \times 10^{-4} \text{kg} \cdot \text{m}^2 (5.14 \text{oz} \cdot \text{in}^2)]$ Use the rubber coupling]

● SH1422-50 □□

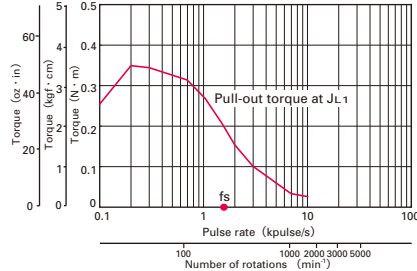

Constant current circuit
 Source voltage : DC24V · operating current : 2A/phase,
 2-phase energization (full-step)
 $J_{L1} = [0.94 \times 10^{-4} \text{kg} \cdot \text{m}^2 (5.14 \text{oz} \cdot \text{in}^2)]$ Use the rubber coupling]

● SH1424-50 □□

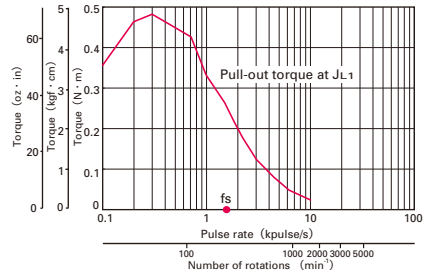

Constant current circuit
 Source voltage : DC24V · operating current : 2A/phase,
 2-phase energization (full-step)
 $J_{L1} = [0.94 \times 10^{-4} \text{kg} \cdot \text{m}^2 (5.14 \text{oz} \cdot \text{in}^2)]$ Use the rubber coupling]

● SH1421-52 □□

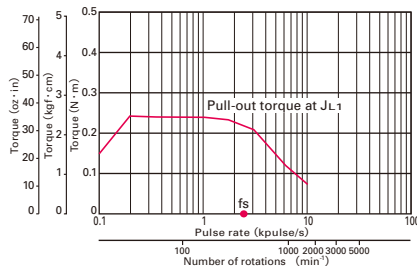

Constant current circuit
 Source voltage : DC24V · operating current : 2A/phase,
 2-phase energization (full-step)
 $J_{L1} = [0.94 \times 10^{-4} \text{kg} \cdot \text{m}^2 (5.14 \text{oz} \cdot \text{in}^2)]$ Use the rubber coupling]

● SH1422-52 □□

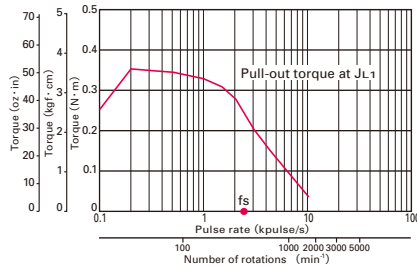

Constant current circuit
 Source voltage : DC24V · operating current : 2A/phase,
 2-phase energization (full-step)
 $J_{L1} = [0.94 \times 10^{-4} \text{kg} \cdot \text{m}^2 (5.14 \text{oz} \cdot \text{in}^2)]$ Use the rubber coupling]

● SH1424-52 □□

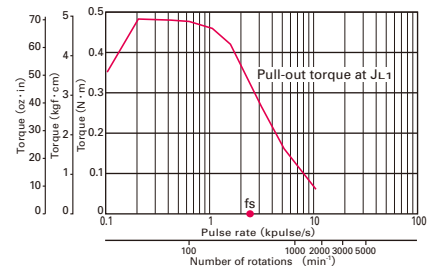

Constant current circuit
 Source voltage : DC24V · operating current : 2A/phase,
 2-phase energization (full-step)
 $J_{L1} = [0.94 \times 10^{-4} \text{kg} \cdot \text{m}^2 (5.14 \text{oz} \cdot \text{in}^2)]$ Use the rubber coupling]

The data are measured under the drive condition of our company. The drive torque may vary depending on the accuracy of customer-side equipment.



2-phase stepping motor

42mm sq. (1.65inch sq.)

103H52 □□
1.8° /step

Unipolar winding • Connector type

Model		Holding torque at 2-phase energization	Rated current	Wiring resistance	Winding inductance	Rotor inertia	Mass (Weight)
Single shaft	Double shafts	[N · m (oz · in) MIN.]	A/phase	Ω /phase	mH/phase	[×10 ⁻⁴ kg · m ² (oz · in ²)]	[kg (lbs)]
103H5205-0440	-0410	0.2 (28.32)	1.2	2.4	2.3	0.036 (0.20)	0.23 (0.51)
103H5208-0440	-0410	0.3 (42.48)	1.2	2.9	3.4	0.056 (0.31)	0.29 (0.64)
103H5209-0440	-0410	0.32 (45.31)	1.2	3	3.9	0.062 (0.34)	0.31 (0.68)
103H5210-0440	-0410	0.37 (52.39)	1.2	3.3	3.4	0.074 (0.40)	0.37 (0.82)

Bipolar winding • Lead wire type

Model		Holding torque at 2-phase energization	Rated current	Wiring resistance	Winding inductance	Rotor inertia	Mass (Weight)
Single shaft	Double shafts	[N · m (oz · in) MIN.]	A/phase	Ω /phase	mH/phase	[×10 ⁻⁴ kg · m ² (oz · in ²)]	[kg (lbs)]
103H5205-5040	-5010	0.23 (32.57)	0.25	54	78	0.036 (0.20)	0.23 (0.51)
103H5205-5140	-5110	0.25 (35.40)	0.5	13.4	23.4	0.036 (0.20)	0.23 (0.51)
103H5205-5240	-5210	0.265 (37.53)	1	3.4	6.5	0.036 (0.20)	0.23 (0.51)
103H5208-5040	-5010	0.35 (49.56)	0.25	66	116	0.056 (0.31)	0.29 (0.64)
103H5208-5140	-5110	0.38 (53.81)	0.5	16.5	34	0.056 (0.31)	0.29 (0.64)
103H5208-5240	-5210	0.39 (55.23)	1	4.1	9.5	0.056 (0.31)	0.29 (0.64)
103H5209-5040	-5010	0.38 (53.81)	0.25	71.4	133	0.062 (0.34)	0.31 (0.68)
103H5209-5140	-5110	0.41 (58.06)	0.5	18.2	39	0.062 (0.34)	0.31 (0.68)
103H5209-5240	-5210	0.425 (60.18)	1	4.4	11	0.062 (0.34)	0.31 (0.68)
103H5210-5040	-5010	0.465 (65.85)	0.25	80	123.3	0.074 (0.40)	0.37 (0.82)
103H5210-5140	-5110	0.49 (69.39)	0.5	20	35	0.074 (0.40)	0.37 (0.82)
103H5210-5240	-5210	0.51 (72.22)	1	4.8	9.5	0.074 (0.40)	0.37 (0.82)

Pulse rate-torque characteristics

● 103H5205-04 □□

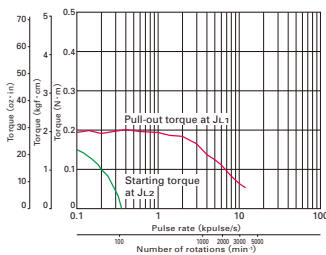

Constant current circuit
Source voltage : DC24V · operating current : 1.2A/phase,
2-phase energization (full-step)
J₁ = [0.94×10⁻⁴kg · m² (5.14 oz · in²) use the rubber coupling]
J₂ = [0.8×10⁻⁴kg · m² (4.37 oz · in²) use the direct coupling]

● 103H5208-04 □□

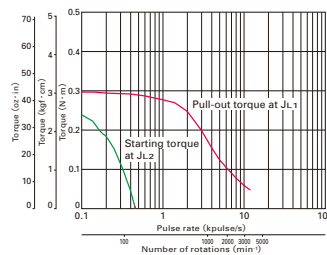

Constant current circuit
Source voltage : DC24V · operating current : 1.2A/phase,
2-phase energization (full-step)
J₁ = [0.94×10⁻⁴kg · m² (5.14 oz · in²) use the rubber coupling]
J₂ = [0.8×10⁻⁴kg · m² (4.37 oz · in²) use the direct coupling]

● 103H5209-04 □□

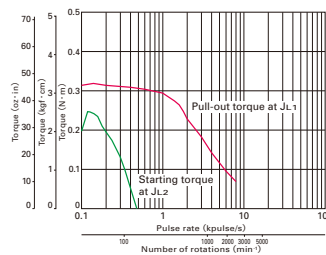

Constant current circuit
Source voltage : DC24V · operating current : 1.2A/phase,
2-phase energization (full-step)
J₁ = [0.94×10⁻⁴kg · m² (5.14 oz · in²) use the rubber coupling]
J₂ = [0.8×10⁻⁴kg · m² (4.37 oz · in²) use the direct coupling]

● 103H5210-04 □□

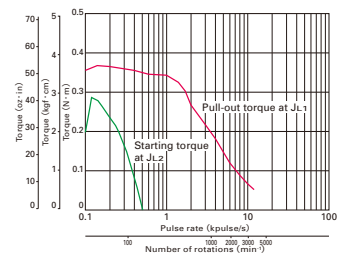

Constant current circuit
Source voltage : DC24V · operating current : 1.2A/phase,
2-phase energization (full-step)
J₁ = [0.94×10⁻⁴kg · m² (5.14 oz · in²) use the rubber coupling]
J₂ = [0.8×10⁻⁴kg · m² (4.37 oz · in²) use the direct coupling]



2-phase stepping motor

50mm sq. (1.97inch sq.)

SS250 □
1.8° / step Bipolar winding

Bipolar winding • Lead wire type

Model		Holding torque at 2-phase energization	Rated current	Wiring resistance	Winding inductance	Rotor inertia	Mass (Weight)
Single shaft	Double shafts	[N · m (oz · in) MIN.]	A/phase	Ω /phase	mH/phase	[×10 ⁻⁴ kg · m ² (oz · in ²)]	[kg (lbs)]
SS2501-5041	-5011	0.1 (14.16)	1	4.5	1.8	0.026 (0.142)	0.09 (0.20)
SS2502-5041	-5011	0.215 (30.44)	1	5.9	3.2	0.049 (0.268)	0.15 (0.33)

Pulse rate-torque characteristics

● SS2501-50 □ □

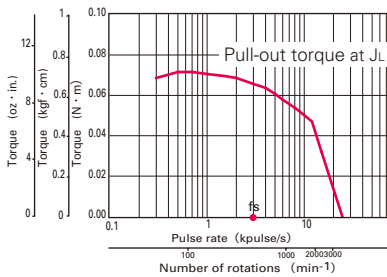

Constant current circuit
Source voltage : DC24V · operating current : 1A/phase,
1-2-phase energization (half-step)
JL = [0.01×10⁻⁴kg · m² (0.055 oz · in²) Pulley balancer system]
fs: No load maximum starting pulse rate

● SS2502-50 □ □

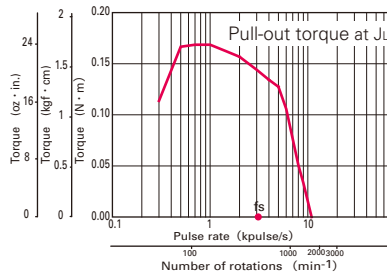

Constant current circuit
Source voltage : DC24V · operating current : 1A/phase,
1-2-phase energization (half-step)
JL = [0.01×10⁻⁴kg · m² (0.055 oz · in²) Pulley balancer system]
fs: No load maximum starting pulse rate

The data are measured under the drive condition of our company. The drive torque may very depending on the accuracy of customer-side equipment.



2-phase stepping motor

50mm sq. (1.97inch sq.)

103H670 □
1.8° /step

Unipolar winding • Lead wire type

Model		Holding torque at 2-phase energization [N · m (oz · in) MIN.]	Rated current A/phase	Wiring resistance		Winding inductance mH/phase	Rotor inertia [×10 ⁻⁴ kg · m ² (oz · in ²)]	Mass (Weight) [kg (lbs)]
Single shaft	Double shafts			Ω /phase				
103H6701-0140	-0110	0.28 (39.6)	1	4.3	6.8	0.057 (0.31)	0.35 (0.77)	
103H6701-0440	-0410	0.28 (39.6)	2	1.1	1.6	0.057 (0.31)	0.35 (0.77)	
103H6701-0740	-0710	0.28 (39.6)	3	0.6	0.7	0.057 (0.31)	0.35 (0.77)	
103H6703-0140	-0110	0.49 (69.4)	1	6	13	0.118 (0.65)	0.5 (1.10)	
103H6703-0440	-0410	0.49 (69.4)	2	1.6	3.2	0.118 (0.65)	0.5 (1.10)	
103H6703-0740	-0710	0.49 (69.4)	3	0.83	1.4	0.118 (0.65)	0.5 (1.10)	
103H6704-0140	-0110	0.53 (75.1)	1	6.5	16.5	0.14 (0.77)	0.55 (1.21)	
103H6704-0440	-0410	0.52 (73.6)	2	1.7	3.8	0.14 (0.77)	0.55 (1.21)	
103H6704-0740	-0710	0.53 (75.1)	3	0.9	1.7	0.14 (0.77)	0.55 (1.21)	

Bipolar winding

Model		Holding torque at 2-phase energization [N · m (oz · in) MIN.]	Rated current A/phase	Wiring resistance		Winding inductance mH/phase	Rotor inertia [×10 ⁻⁴ kg · m ² (oz · in ²)]	Mass (Weight) [kg (lbs)]
Single shaft	Double shafts			Ω /phase				
103H6701-5040	-5010	0.28 (39.6)	2	0.6	1.6	0.57 (0.31)	0.35 (0.77)	
103H6703-5040	-5010	0.09 (12.7)	2	0.8	3.2	0.118 (0.65)	0.5 (1.10)	
103H6704-5040	-5010	0.52 (73.6)	2	0.9	3.8	0.14 (0.77)	0.55 (1.21)	

Pulse rate-torque characteristics

103H6701-01

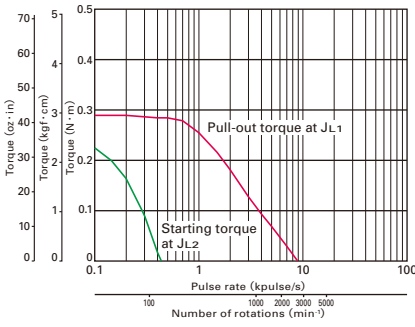

Constant current circuit
 Source voltage : DC24V · operating current : 1A/phase,
 2-phase energization (full-step)
 $J_{L1} = [0.94 \times 10^{-4} \text{kg} \cdot \text{m}^2 (5.14 \text{oz} \cdot \text{in}^2)]$ use the rubber coupling
 $J_{L2} = [0.8 \times 10^{-4} \text{kg} \cdot \text{m}^2 (4.37 \text{oz} \cdot \text{in}^2)]$ use the direct coupling

103H6701-04

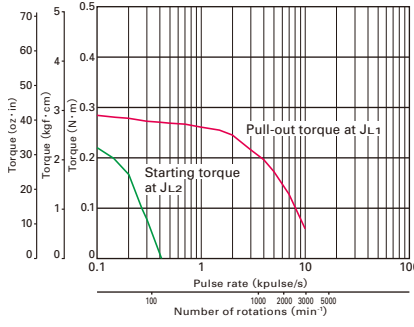

Constant current circuit
 Source voltage : DC24V · operating current : 2A/phase,
 2-phase energization (full-step)
 $J_{L1} = [0.94 \times 10^{-4} \text{kg} \cdot \text{m}^2 (5.14 \text{oz} \cdot \text{in}^2)]$ use the rubber coupling
 $J_{L2} = [0.8 \times 10^{-4} \text{kg} \cdot \text{m}^2 (4.37 \text{oz} \cdot \text{in}^2)]$ use the direct coupling

103H6701-07

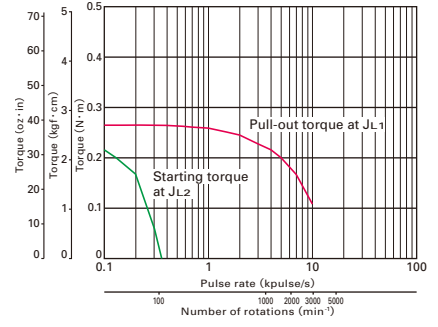

Constant current circuit
 Source voltage : DC24V · operating current : 3A/phase,
 2-phase energization (full-step)
 $J_{L1} = [0.94 \times 10^{-4} \text{kg} \cdot \text{m}^2 (5.14 \text{oz} \cdot \text{in}^2)]$ use the rubber coupling
 $J_{L2} = [0.8 \times 10^{-4} \text{kg} \cdot \text{m}^2 (4.37 \text{oz} \cdot \text{in}^2)]$ use the direct coupling

103H6703-01

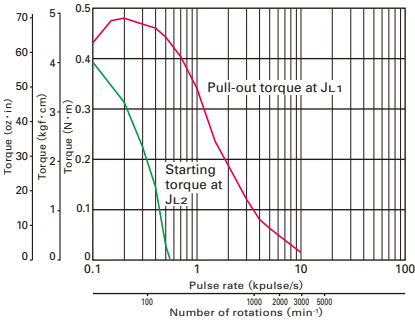

Constant current circuit
 Source voltage : DC24V · operating current : 1A/phase,
 2-phase energization (full-step)
 $J_{L1} = [0.94 \times 10^{-4} \text{kg} \cdot \text{m}^2 (5.14 \text{oz} \cdot \text{in}^2)]$ use the rubber coupling
 $J_{L2} = [0.8 \times 10^{-4} \text{kg} \cdot \text{m}^2 (4.37 \text{oz} \cdot \text{in}^2)]$ use the direct coupling

103H6703-04

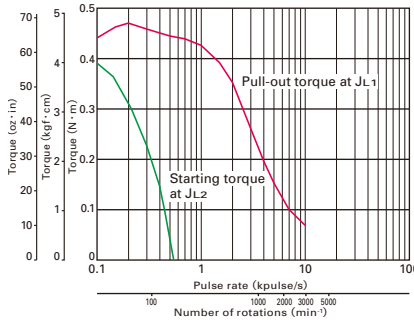

Constant current circuit
 Source voltage : DC24V · operating current : 2A/phase,
 2-phase energization (full-step)
 $J_{L1} = [0.94 \times 10^{-4} \text{kg} \cdot \text{m}^2 (5.14 \text{oz} \cdot \text{in}^2)]$ use the rubber coupling
 $J_{L2} = [0.8 \times 10^{-4} \text{kg} \cdot \text{m}^2 (4.37 \text{oz} \cdot \text{in}^2)]$ use the direct coupling

103H6703-07

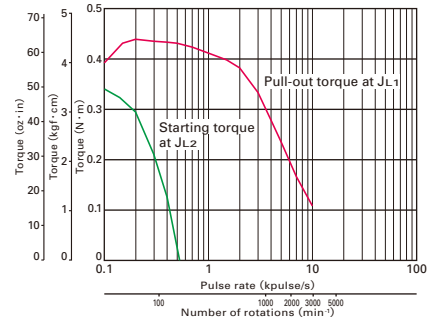

Constant current circuit
 Source voltage : DC24V · operating current : 3A/phase,
 2-phase energization (full-step)
 $J_{L1} = [0.94 \times 10^{-4} \text{kg} \cdot \text{m}^2 (5.14 \text{oz} \cdot \text{in}^2)]$ use the rubber coupling
 $J_{L2} = [0.8 \times 10^{-4} \text{kg} \cdot \text{m}^2 (4.37 \text{oz} \cdot \text{in}^2)]$ use the direct coupling

103H6704-01

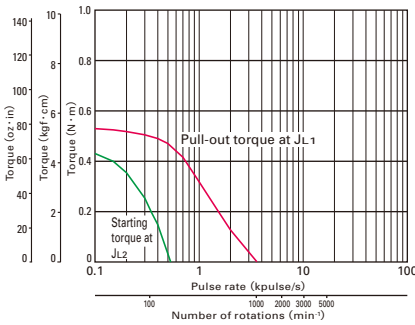

Constant current circuit
 Source voltage : DC24V · operating current : 1A/phase,
 2-phase energization (full-step)
 $J_{L1} = [0.94 \times 10^{-4} \text{kg} \cdot \text{m}^2 (5.14 \text{oz} \cdot \text{in}^2)]$ use the rubber coupling
 $J_{L2} = [0.8 \times 10^{-4} \text{kg} \cdot \text{m}^2 (4.37 \text{oz} \cdot \text{in}^2)]$ use the direct coupling

103H6704-04

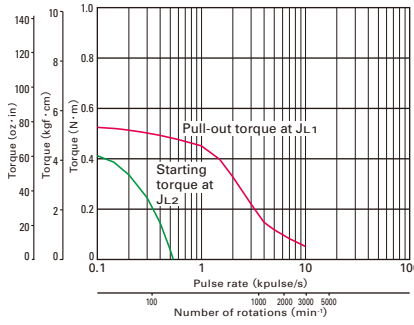

Constant current circuit
 Source voltage : DC24V · operating current : 2A/phase,
 2-phase energization (full-step)
 $J_{L1} = [0.94 \times 10^{-4} \text{kg} \cdot \text{m}^2 (5.14 \text{oz} \cdot \text{in}^2)]$ use the rubber coupling
 $J_{L2} = [0.8 \times 10^{-4} \text{kg} \cdot \text{m}^2 (4.37 \text{oz} \cdot \text{in}^2)]$ use the direct coupling

103H6704-07

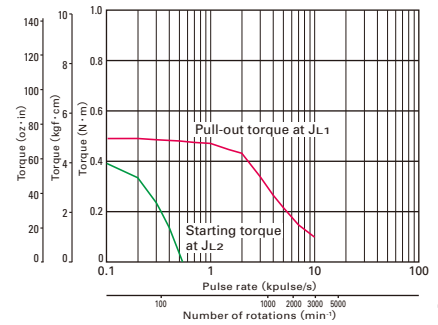

Constant current circuit
 Source voltage : DC24V · operating current : 3A/phase,
 2-phase energization (full-step)
 $J_{L1} = [0.94 \times 10^{-4} \text{kg} \cdot \text{m}^2 (5.14 \text{oz} \cdot \text{in}^2)]$ use the rubber coupling
 $J_{L2} = [0.8 \times 10^{-4} \text{kg} \cdot \text{m}^2 (4.37 \text{oz} \cdot \text{in}^2)]$ use the direct coupling

103H6701-50

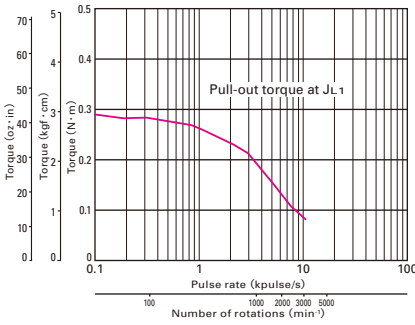

Constant current circuit
 Source voltage : DC24V · operating current : 2A/phase,
 2-phase energization (full-step)
 $J_{L1} = [0.94 \times 10^{-4} \text{kg} \cdot \text{m}^2 (5.14 \text{oz} \cdot \text{in}^2)]$ use the rubber coupling

103H6703-50

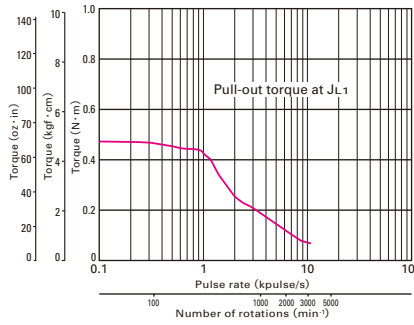

Constant current circuit
 Source voltage : DC24V · operating current : 2A/phase,
 2-phase energization (full-step)
 $J_{L1} = [0.94 \times 10^{-4} \text{kg} \cdot \text{m}^2 (5.14 \text{oz} \cdot \text{in}^2)]$ use the rubber coupling

103H6704-50

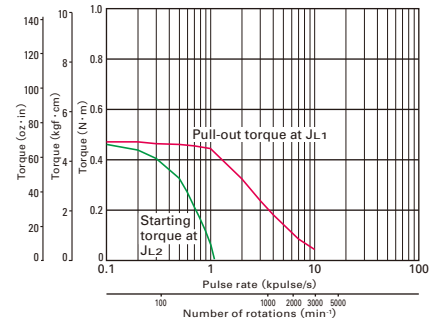

Constant current circuit
 Source voltage : DC24V · operating current : 2A/phase,
 2-phase energization (full-step)
 $J_{L1} = [0.94 \times 10^{-4} \text{kg} \cdot \text{m}^2 (5.14 \text{oz} \cdot \text{in}^2)]$ use the rubber coupling
 $J_{L2} = [0.14 \times 10^{-4} \text{kg} \cdot \text{m}^2 (0.77 \text{oz} \cdot \text{in}^2)]$ pulley balancer method



2-phase stepping motor

56mm sq. (2.20inch sq.)

103H712 □
1.8° /step

Unipolar winding • Lead wire type

Model		Holding torque at 2-phase energization [N · m (oz · in) MIN.]	Rated current A/phase	Wiring resistance Ω /phase	Winding inductance mH/phase	Rotor inertia [×10 ⁻⁴ kg · m ² (oz · in ²)]	Mass (Weight) [kg (lbs)]
Single shaft	Double shafts						
103H7121-0140	-0110	0.39 (55.2)	1	4.8	8	0.1 (0.55)	0.47 (1.04)
103H7121-0440	-0410	0.39 (55.2)	2	1.25	1.9	0.1 (0.55)	0.47 (1.04)
103H7121-0740	-0710	0.39 (55.2)	3	0.6	0.8	0.1 (0.55)	0.47 (1.04)
103H7123-0140	-0110	0.83 (117.)	1	6.7	15	0.21 (1.15)	0.65 (1.43)
103H7123-0440	-0410	0.83 (117.5)	2	1.6	3.8	0.21 (1.15)	0.65 (1.43)
103H7123-0740	-0710	0.78 (110.5)	3	0.77	1.58	0.21 (1.15)	0.65 (1.43)
103H7124-0140	-0110	0.98 (138.8)	1	7	14.5	0.245 (1.34)	0.8 (1.76)
103H7124-0440	-0410	0.98 (138.8)	2	1.7	3.1	0.245 (1.34)	0.8 (1.76)
103H7124-0740	-0710	0.98 (138.8)	3	0.74	1.4	0.245 (1.34)	0.8 (1.76)
103H7126-0140	-0110	1.27 (179.8)	1	8.6	19	0.36 (1.97)	0.98 (2.16)
103H7126-0440	-0410	1.27 (179.8)	2	2	4.5	0.36 (1.97)	0.98 (2.16)
103H7126-0740	-0710	1.27 (179.8)	3	0.9	2.2	0.36 (1.97)	0.98 (2.16)

Bipolar winding • Lead wire type

Model		Holding torque at 2-phase energization [N · m (oz · in) MIN.]	Rated current A/phase	Wiring resistance Ω /phase	Winding inductance mH/phase	Rotor inertia [×10 ⁻⁴ kg · m ² (oz · in ²)]	Mass (Weight) [kg (lbs)]
Single shaft	Double shafts						
103H7121-5640	-5610	0.55 (77.9)	1	4.3	14.5	0.1 (0.55)	0.47 (1.04)
103H7121-5740	-5710	0.55 (77.9)	2	1.1	3.7	0.1 (0.55)	0.47 (1.04)
103H7121-5840	-5810	0.55 (77.9)	3	0.54	1.74	0.1 (0.55)	0.47 (1.04)
103H7123-5640	-5610	1.0 (141.6)	1	5.7	29.4	0.21 (1.15)	0.65 (1.43)
103H7123-5740	-5710	1.0 (141.6)	2	1.5	7.5	0.21 (1.15)	0.65 (1.43)
103H7123-5840	-5810	1.0 (141.6)	3	0.7	3.5	0.21 (1.15)	0.65 (1.43)
103H7126-5640	-5610	1.6 (226.6)	1	7.7	34.6	0.36 (1.97)	0.98 (2.16)
103H7126-5740	-5710	1.6 (226.6)	2	2	9.1	0.36 (1.97)	0.98 (2.16)
103H7126-5840	-5810	1.6 (226.6)	3	0.94	4	0.36 (1.97)	0.98 (2.16)
103H7128-5640	-5610	2.0 (283.2)	1	8.9	40.1	0.49 (2.68)	1.3 (2.87)
103H7128-5740	-5710	2.0 (283.2)	2	2.3	10.4	0.49 (2.68)	1.3 (2.87)
103H7128-5840	-5810	2.0 (283.2)	3	1.03	4.3	0.49 (2.68)	1.3 (2.87)

Pulse rate-torque characteristics

● 103H7121-01 □□

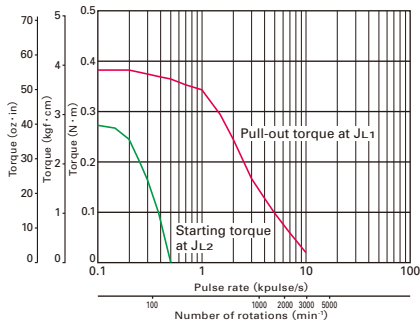

Constant current circuit
Source voltage : DC24V · operating current : 1A/phase,
2-phase energization (full-step)
 $J_{L1} = [0.94 \times 10^{-4} \text{kg} \cdot \text{m}^2 (5.14 \text{ oz} \cdot \text{in}^2) \text{ use the rubber coupling}]$
 $J_{L2} = [0.8 \times 10^{-4} \text{kg} \cdot \text{m}^2 (4.37 \text{ oz} \cdot \text{in}^2) \text{ use the direct coupling}]$

● 103H7121-04 □□

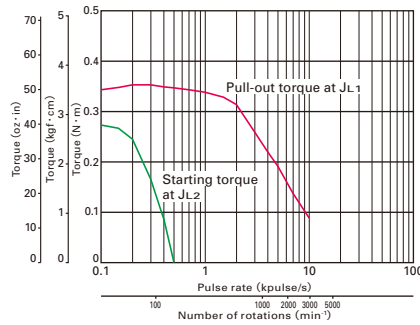

Constant current circuit
Source voltage : DC24V · operating current : 2A/phase,
2-phase energization (full-step)
 $J_{L1} = [0.94 \times 10^{-4} \text{kg} \cdot \text{m}^2 (5.14 \text{ oz} \cdot \text{in}^2) \text{ use the rubber coupling}]$
 $J_{L2} = [0.8 \times 10^{-4} \text{kg} \cdot \text{m}^2 (4.37 \text{ oz} \cdot \text{in}^2) \text{ use the direct coupling}]$

● 103H7121-07 □□

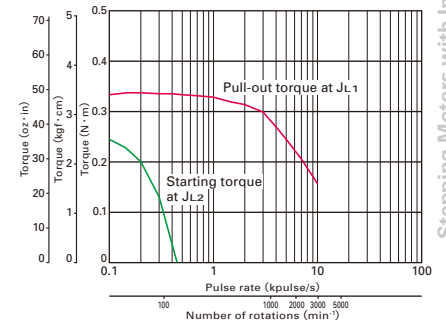

Constant current circuit
Source voltage : DC24V · operating current : 3A/phase,
2-phase energization (full-step)
 $J_{L1} = [0.94 \times 10^{-4} \text{kg} \cdot \text{m}^2 (5.14 \text{ oz} \cdot \text{in}^2) \text{ use the rubber coupling}]$
 $J_{L2} = [0.8 \times 10^{-4} \text{kg} \cdot \text{m}^2 (4.37 \text{ oz} \cdot \text{in}^2) \text{ use the direct coupling}]$

● 103H7123-01 □□

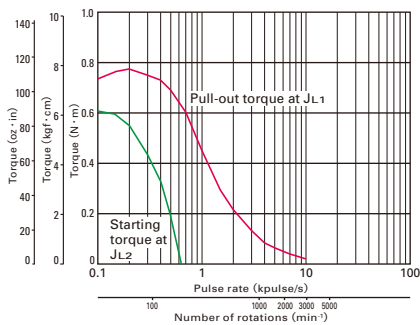

Constant current circuit
Source voltage : DC24V · operating current : 1A/phase,
2-phase energization (full-step)
 $J_{L1} = [0.94 \times 10^{-4} \text{kg} \cdot \text{m}^2 (5.14 \text{ oz} \cdot \text{in}^2) \text{ use the rubber coupling}]$
 $J_{L2} = [0.8 \times 10^{-4} \text{kg} \cdot \text{m}^2 (4.37 \text{ oz} \cdot \text{in}^2) \text{ use the direct coupling}]$

● 103H7123-04 □□

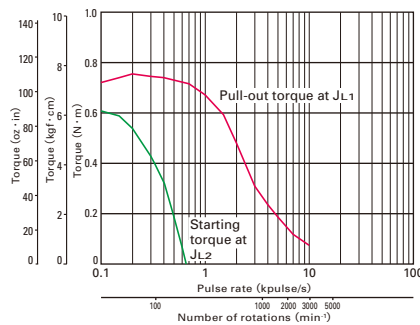

Constant current circuit
Source voltage : DC24V · operating current : 2A/phase,
2-phase energization (full-step)
 $J_{L1} = [0.94 \times 10^{-4} \text{kg} \cdot \text{m}^2 (5.14 \text{ oz} \cdot \text{in}^2) \text{ use the rubber coupling}]$
 $J_{L2} = [0.8 \times 10^{-4} \text{kg} \cdot \text{m}^2 (4.37 \text{ oz} \cdot \text{in}^2) \text{ use the direct coupling}]$

● 103H7123-07 □□

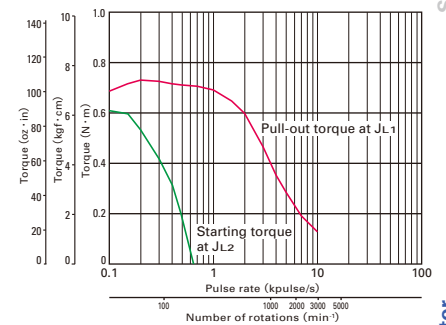

Constant current circuit
Source voltage : DC24V · operating current : 3A/phase,
2-phase energization (full-step)
 $J_{L1} = [0.94 \times 10^{-4} \text{kg} \cdot \text{m}^2 (5.14 \text{ oz} \cdot \text{in}^2) \text{ use the rubber coupling}]$
 $J_{L2} = [0.8 \times 10^{-4} \text{kg} \cdot \text{m}^2 (4.37 \text{ oz} \cdot \text{in}^2) \text{ use the direct coupling}]$

● 103H7124-01 □□

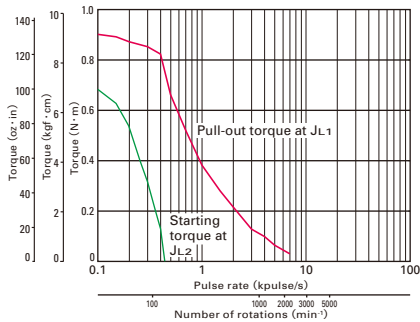

Constant current circuit
Source voltage : DC24V · operating current : 1A/phase,
2-phase energization (full-step)
 $J_{L1} = [2.6 \times 10^{-4} \text{kg} \cdot \text{m}^2 (14.22 \text{ oz} \cdot \text{in}^2) \text{ use the rubber coupling}]$
 $J_{L2} = [2.6 \times 10^{-4} \text{kg} \cdot \text{m}^2 (14.22 \text{ oz} \cdot \text{in}^2) \text{ use the direct coupling}]$

● 103H7124-04 □□

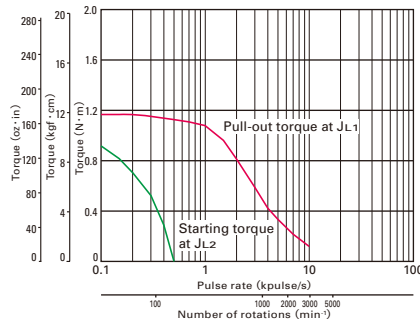

Constant current circuit
Source voltage : DC24V · operating current : 2A/phase,
2-phase energization (full-step)
 $J_{L1} = [2.6 \times 10^{-4} \text{kg} \cdot \text{m}^2 (14.22 \text{ oz} \cdot \text{in}^2) \text{ use the rubber coupling}]$
 $J_{L2} = [2.6 \times 10^{-4} \text{kg} \cdot \text{m}^2 (14.22 \text{ oz} \cdot \text{in}^2) \text{ use the direct coupling}]$

● 103H7124-07 □□

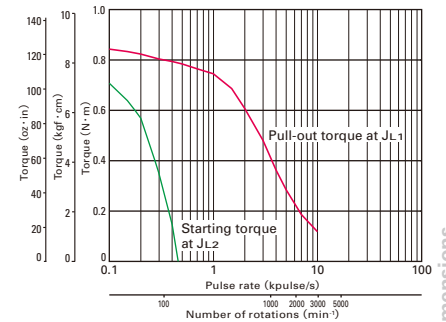

Constant current circuit
Source voltage : DC24V · operating current : 3A/phase,
2-phase energization (full-step)
 $J_{L1} = [2.6 \times 10^{-4} \text{kg} \cdot \text{m}^2 (14.22 \text{ oz} \cdot \text{in}^2) \text{ use the rubber coupling}]$
 $J_{L2} = [2.6 \times 10^{-4} \text{kg} \cdot \text{m}^2 (14.22 \text{ oz} \cdot \text{in}^2) \text{ use the direct coupling}]$

● 103H7126-01 □□

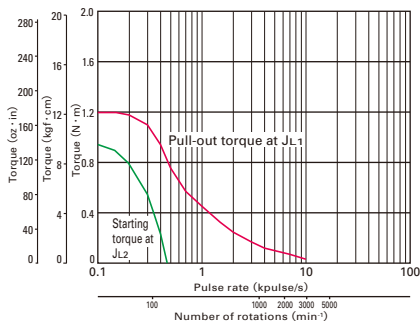

Constant current circuit
Source voltage : DC24V · operating current : 1A/phase,
2-phase energization (full-step)
 $J_{L1} = [2.6 \times 10^{-4} \text{kg} \cdot \text{m}^2 (14.22 \text{ oz} \cdot \text{in}^2) \text{ use the rubber coupling}]$
 $J_{L2} = [2.6 \times 10^{-4} \text{kg} \cdot \text{m}^2 (14.22 \text{ oz} \cdot \text{in}^2) \text{ use the direct coupling}]$

● 103H7126-04 □□

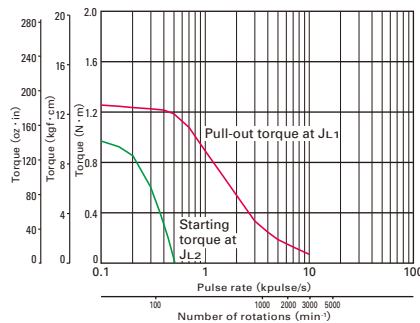

Constant current circuit
Source voltage : DC24V · operating current : 2A/phase,
2-phase energization (full-step)
 $J_{L1} = [2.6 \times 10^{-4} \text{kg} \cdot \text{m}^2 (14.22 \text{ oz} \cdot \text{in}^2) \text{ use the rubber coupling}]$
 $J_{L2} = [2.6 \times 10^{-4} \text{kg} \cdot \text{m}^2 (14.22 \text{ oz} \cdot \text{in}^2) \text{ use the direct coupling}]$

● 103H7126-07 □□

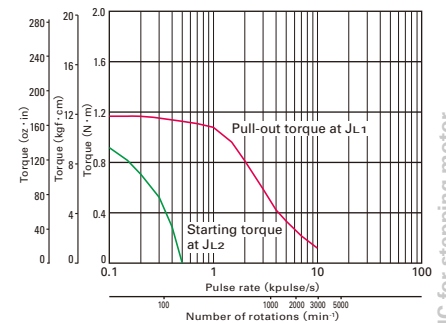

Constant current circuit
Source voltage : DC24V · operating current : 3A/phase,
2-phase energization (full-step)
 $J_{L1} = [2.6 \times 10^{-4} \text{kg} \cdot \text{m}^2 (14.22 \text{ oz} \cdot \text{in}^2) \text{ use the rubber coupling}]$
 $J_{L2} = [2.6 \times 10^{-4} \text{kg} \cdot \text{m}^2 (14.22 \text{ oz} \cdot \text{in}^2) \text{ use the direct coupling}]$

● 103H7121-56 □□

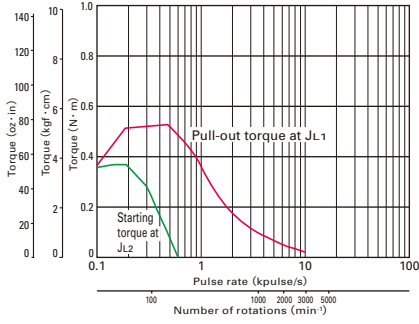

Constant current circuit
Source voltage : DC24V · operating current : 1A/phase,
2-phase energization (full-step)
 $J_{L1} = [0.94 \times 10^{-4} \text{kg} \cdot \text{m}^2 (5.14 \text{oz} \cdot \text{in}^2)$ use the rubber coupling]
 $J_{L2} = [0.8 \times 10^{-4} \text{kg} \cdot \text{m}^2 (4.37 \text{oz} \cdot \text{in}^2)$ use the direct coupling

● 103H7121-57 □□

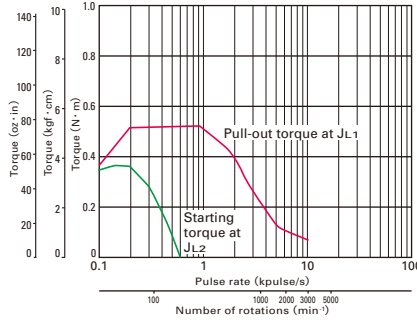

Constant current circuit
Source voltage : DC24V · operating current : 2A/phase,
2-phase energization (full-step)
 $J_{L1} = [0.94 \times 10^{-4} \text{kg} \cdot \text{m}^2 (5.14 \text{oz} \cdot \text{in}^2)$ use the rubber coupling]
 $J_{L2} = [0.8 \times 10^{-4} \text{kg} \cdot \text{m}^2 (4.37 \text{oz} \cdot \text{in}^2)$ use the direct coupling

● 103H7121-58 □□

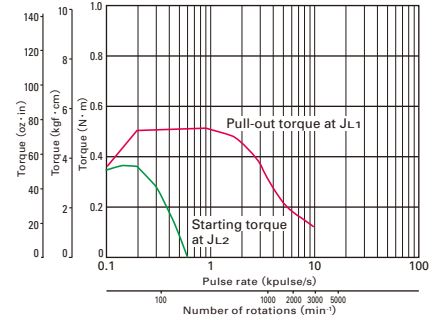

Constant current circuit
Source voltage : DC24V · operating current : 3A/phase,
2-phase energization (full-step)
 $J_{L1} = [0.94 \times 10^{-4} \text{kg} \cdot \text{m}^2 (5.14 \text{oz} \cdot \text{in}^2)$ use the rubber coupling]
 $J_{L2} = [0.8 \times 10^{-4} \text{kg} \cdot \text{m}^2 (4.37 \text{oz} \cdot \text{in}^2)$ use the direct coupling

● 103H7123-56 □□

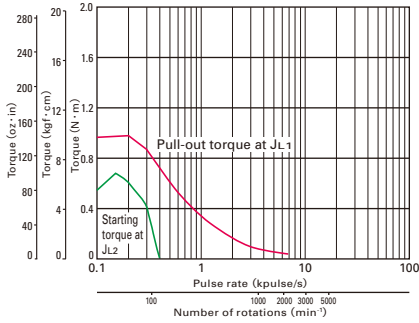

Constant current circuit
Source voltage : DC24V · operating current : 1A/phase,
2-phase energization (full-step)
 $J_{L1} = [2.6 \times 10^{-4} \text{kg} \cdot \text{m}^2 (14.22 \text{oz} \cdot \text{in}^2)$ use the rubber coupling]
 $J_{L2} = [2.6 \times 10^{-4} \text{kg} \cdot \text{m}^2 (14.22 \text{oz} \cdot \text{in}^2)$ use the direct coupling

● 103H7123-57 □□

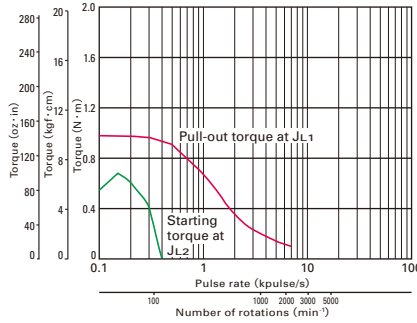

Constant current circuit
Source voltage : DC24V · operating current : 2A/phase,
2-phase energization (full-step)
 $J_{L1} = [2.6 \times 10^{-4} \text{kg} \cdot \text{m}^2 (14.22 \text{oz} \cdot \text{in}^2)$ use the rubber coupling]
 $J_{L2} = [2.6 \times 10^{-4} \text{kg} \cdot \text{m}^2 (14.22 \text{oz} \cdot \text{in}^2)$ use the direct coupling

● 103H7123-58 □□

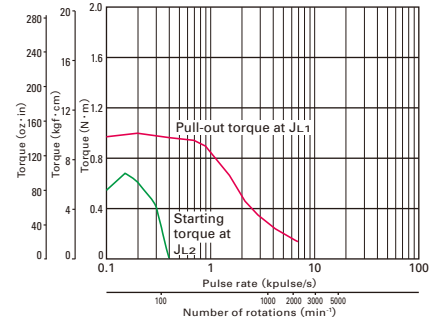

Constant current circuit
Source voltage : DC24V · operating current : 3A/phase,
2-phase energization (full-step)
 $J_{L1} = [2.6 \times 10^{-4} \text{kg} \cdot \text{m}^2 (14.22 \text{oz} \cdot \text{in}^2)$ use the rubber coupling]
 $J_{L2} = [2.6 \times 10^{-4} \text{kg} \cdot \text{m}^2 (14.22 \text{oz} \cdot \text{in}^2)$ use the direct coupling

● 103H7126-56 □□

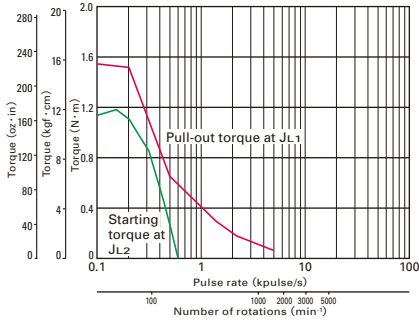

Constant current circuit
Source voltage : DC24V · operating current : 1A/phase,
2-phase energization (full-step)
 $J_{L1} = [2.6 \times 10^{-4} \text{kg} \cdot \text{m}^2 (14.22 \text{oz} \cdot \text{in}^2)$ use the rubber coupling]
 $J_{L2} = [2.6 \times 10^{-4} \text{kg} \cdot \text{m}^2 (14.22 \text{oz} \cdot \text{in}^2)$ use the direct coupling

● 103H7126-57 □□

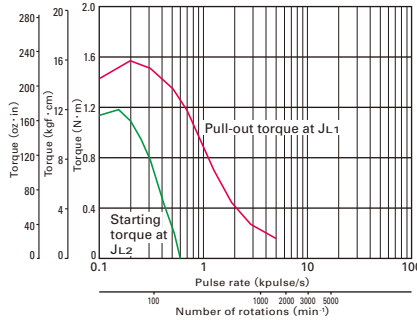

Constant current circuit
Source voltage : DC24V · operating current : 2A/phase,
2-phase energization (full-step)
 $J_{L1} = [2.6 \times 10^{-4} \text{kg} \cdot \text{m}^2 (14.22 \text{oz} \cdot \text{in}^2)$ use the rubber coupling]
 $J_{L2} = [2.6 \times 10^{-4} \text{kg} \cdot \text{m}^2 (14.22 \text{oz} \cdot \text{in}^2)$ use the direct coupling

● 103H7126-58 □□

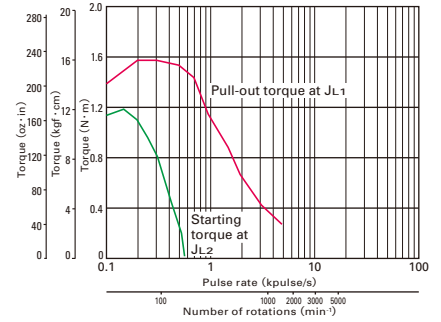

Constant current circuit
Source voltage : DC24V · operating current : 3A/phase,
2-phase energization (full-step)
 $J_{L1} = [2.6 \times 10^{-4} \text{kg} \cdot \text{m}^2 (14.22 \text{oz} \cdot \text{in}^2)$ use the rubber coupling]
 $J_{L2} = [2.6 \times 10^{-4} \text{kg} \cdot \text{m}^2 (14.22 \text{oz} \cdot \text{in}^2)$ use the direct coupling

● 103H7128-56 □□

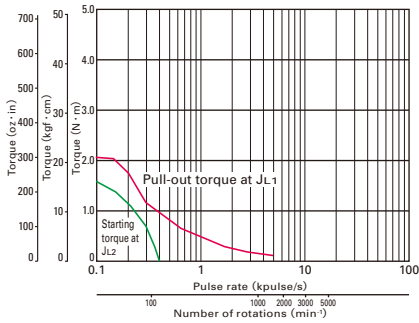

Constant current circuit
Source voltage : DC24V · operating current : 1A/phase,
2-phase energization (full-step)
 $J_{L1} = [7.4 \times 10^{-4} \text{kg} \cdot \text{m}^2 (40.46 \text{oz} \cdot \text{in}^2)$ use the rubber coupling]
 $J_{L2} = [7.4 \times 10^{-4} \text{kg} \cdot \text{m}^2 (40.46 \text{oz} \cdot \text{in}^2)$ use the direct coupling

● 103H7128-57 □□

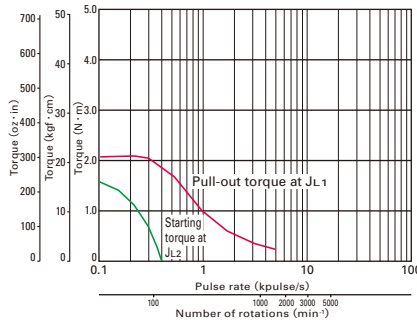

Constant current circuit
Source voltage : DC24V · operating current : 2A/phase,
2-phase energization (full-step)
 $J_{L1} = [7.4 \times 10^{-4} \text{kg} \cdot \text{m}^2 (40.46 \text{oz} \cdot \text{in}^2)$ use the rubber coupling]
 $J_{L2} = [7.4 \times 10^{-4} \text{kg} \cdot \text{m}^2 (40.46 \text{oz} \cdot \text{in}^2)$ use the direct coupling

● 103H7128-58 □□

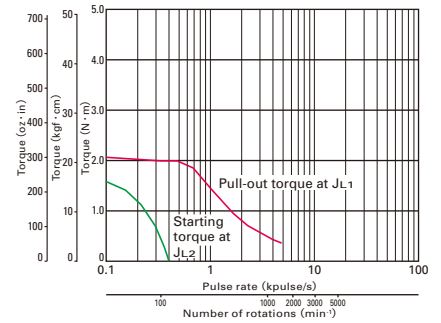

Constant current circuit
Source voltage : DC24V · operating current : 3A/phase,
2-phase energization (full-step)
 $J_{L1} = [7.4 \times 10^{-4} \text{kg} \cdot \text{m}^2 (40.46 \text{oz} \cdot \text{in}^2)$ use the rubber coupling]
 $J_{L2} = [7.4 \times 10^{-4} \text{kg} \cdot \text{m}^2 (40.46 \text{oz} \cdot \text{in}^2)$ use the direct coupling



2-phase stepping motor

60mm sq. (2.36inch sq.)

SH160 □
0.9° /step

Unipolar winding • Lead wire type

Model		Holding torque at 2-phase energization	Rated current	Wiring resistance	Winding inductance	Rotor inertia	Mass (Weight)
Single shaft	Double shafts	[N · m (oz · in) MIN.]	A/phase	Ω /phase	mH/phase	[$\times 10^{-4}$ kg · m ² (oz · in ²)]	[kg (lbs)]
SH1601-0440	-0410	0.57 (80.71)	2	1.35	2	0.24 (1.312)	0.55 (1.21)
SH1602-0440	-0410	1.1 (155.77)	2	1.8	3.5	0.4 (2.187)	0.8 (1.76)
SH1603-0440	-0410	1.7 (240.74)	2	2.3	4.5	0.75 (4.101)	1.2 (2.64)

Pulse rate-torque characteristics

● SH1601-04 □ □

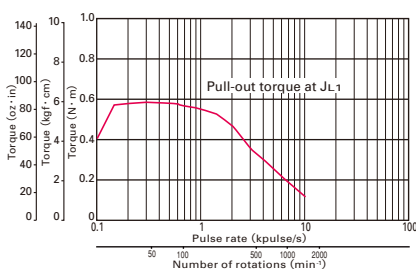

Constant current circuit
Source voltage : DC24V · operating current : 2A/phase,
2-phase energization (full-step)
 $J_{L1} = [0.94 \times 10^{-4} \text{kg} \cdot \text{m}^2 (5.14 \text{oz} \cdot \text{in}^2)]$ use the rubber coupling]

● SH1602-04 □ □

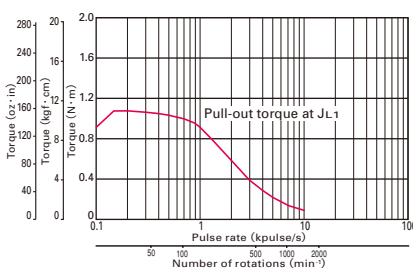

Constant current circuit
Source voltage : DC24V · operating current : 2A/phase,
2-phase energization (full-step)
 $J_{L1} = [2.6 \times 10^{-4} \text{kg} \cdot \text{m}^2 (14.22 \text{oz} \cdot \text{in}^2)]$ use the rubber coupling]

● SH1603-04 □ □

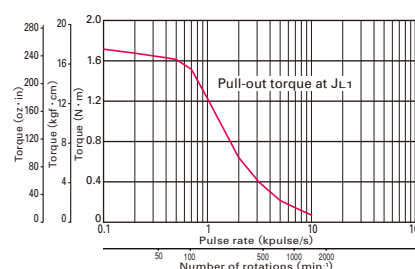

Constant current circuit
Source voltage : DC24V · operating current : 2A/phase,
2-phase energization (full-step)
 $J_{L1} = [7.4 \times 10^{-4} \text{kg} \cdot \text{m}^2 (40.46 \text{oz} \cdot \text{in}^2)]$ use the rubber coupling]

The data are measured under the drive condition of our company. The drive torque may vary depending on the accuracy of customer-side equipment.

Bipolar winding • Lead wire type

Model		Holding torque at 2-phase energization	Rated current	Wiring resistance	Winding inductance	Rotor inertia	Mass (Weight)
Single shaft	Double shafts	[N · m (oz · in) MIN.]	A/phase	Ω /phase	mH/phase	[$\times 10^{-4}$ kg · m ² (oz · in ²)]	[kg (lbs)]
SH1601-5240	-5210	0.69 (97.7)	2	1.2	3.5	0.24 (1.31)	0.55 (1.21)
SH1602-5240	-5210	1.28 (181.2)	2	1.65	6.1	0.4 (2.19)	0.8 (1.76)
SH1603-5240	-5210	2.15 (304.4)	2	2.3	8.8	0.75 (4.10)	1.2 (2.65)

Pulse rate-torque characteristics

● SH1601-52 □ □

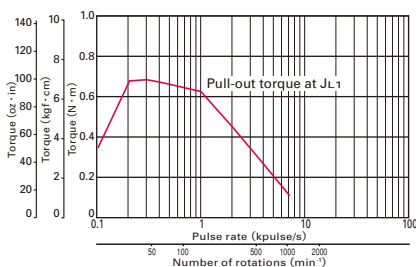

Constant current circuit
Source voltage : DC24V · operating current : 2A/phase,
2-phase energization (full-step)
 $J_{L1} = [0.94 \times 10^{-4} \text{kg} \cdot \text{m}^2 (5.14 \text{oz} \cdot \text{in}^2)]$ use the rubber coupling]

● SH1602-52 □ □

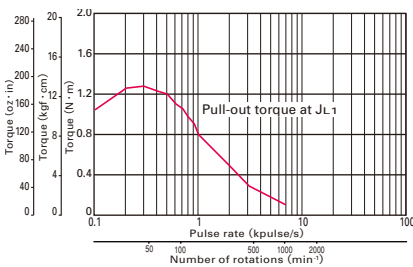

Constant current circuit
Source voltage : DC24V · operating current : 2A/phase,
2-phase energization (full-step)
 $J_{L1} = [2.6 \times 10^{-4} \text{kg} \cdot \text{m}^2 (14.22 \text{oz} \cdot \text{in}^2)]$ use the rubber coupling]

● SH1603-52 □ □

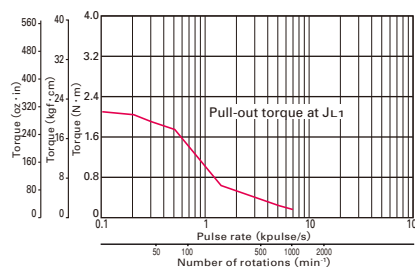

Constant current circuit
Source voltage : DC24V · operating current : 2A/phase,
2-phase energization (full-step)
 $J_{L1} = [7.4 \times 10^{-4} \text{kg} \cdot \text{m}^2 (40.46 \text{oz} \cdot \text{in}^2)]$ use the rubber coupling]

The data are measured under the drive condition of our company. The drive torque may vary depending on the accuracy of customer-side equipment.



2-phase stepping motor

60mm sq. (2.36inch sq.)

103H782 □
1.8° /step

Unipolar winding • Connector type

Model		Holding torque at 2-phase energization	Rated current	Wiring resistance	Winding inductance	Rotor inertia	Mass (Weight)
Single shaft	Double shafts	[N · m (oz · in) MIN.]	A/phase	Ω /phase	mH/phase	[×10 ⁻⁴ kg · m ² (oz · in ²)]	[kg (lbs)]
103H7821-0140	-0110	0.78 (110.5)	1	5.7	8.3	0.275 (1.50)	0.6 (1.32)
103H7821-0440	-0410	0.78 (110.5)	2	1.5	2	0.275 (1.50)	0.6 (1.32)
103H7821-0740	-0710	0.78 (110.5)	3	0.68	0.8	0.275 (1.50)	0.6 (1.32)
103H7822-0140	-0110	1.17 (165.7)	1	6.9	14	0.4 (2.19)	0.77 (1.70)
103H7822-0440	-0410	1.17 (165.7)	2	1.8	3.6	0.4 (2.19)	0.77 (1.70)
103H7822-0740	-0710	1.17 (165.7)	3	0.8	1.38	0.4 (2.19)	0.77 (1.70)
103H7823-0140	-0110	2.1 (297.4)	1	10	21.7	0.84 (4.59)	1.34 (2.95)
103H7823-0440	-0410	2.1 (297.4)	2	2.7	5.6	0.84 (4.59)	1.34 (2.95)
103H7823-0740	-0710	2.1 (297.4)	3	1.25	2.4	0.84 (4.59)	1.34 (2.95)

Bipolar winding • Connector type

Model		Holding torque at 2-phase energization	Rated current	Wiring resistance	Winding inductance	Rotor inertia	Mass (Weight)
Single shaft	Double shafts	[N · m (oz · in) MIN.]	A/phase	Ω /phase	mH/phase	[×10 ⁻⁴ kg · m ² (oz · in ²)]	[kg (lbs)]
103H7821-1740	-1710	0.88 (124.6)	4	0.35	0.8	0.275 (1.50)	0.6 (1.32)
103H7821-5740	-5710	0.88 (124.6)	2	1.27	3.3	0.275 (1.50)	0.6 (1.32)
103H7822-1740	-1710	1.37 (194.0)	4	0.43	1.38	0.4 (2.19)	0.77 (1.70)
103H7822-5740	-5710	1.37 (194.0)	2	1.55	5.5	0.4 (2.19)	0.77 (1.70)
103H7823-1740	-1710	2.7 (382.3)	4	0.65	2.4	0.84 (4.59)	1.34 (2.95)
103H7823-5740	-5710	2.7 (382.3)	2	2.4	9.5	0.84 (4.59)	1.34 (2.95)

Pulse rate-torque characteristics

● 103H7821-01 □ □

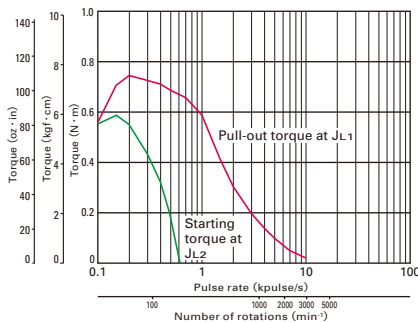

Constant current circuit
Source voltage : DC24V · operating current : 1A/phase,
2-phase energization (full-step)
J_{L1} = [0.94×10⁻⁴kg · m² (5.14 oz · in²) use the rubber coupling]
J_{L2} = [0.8×10⁻⁴kg · m² (4.37 oz · in²) use the direct coupling]

● 103H7821-04 □ □

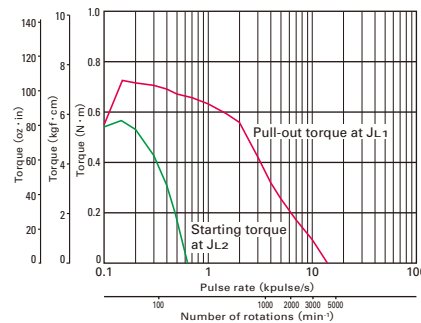

Constant current circuit
Source voltage : DC24V · operating current : 2A/phase,
2-phase energization (full-step)
J_{L1} = [0.94×10⁻⁴kg · m² (5.14 oz · in²) use the rubber coupling]
J_{L2} = [0.8×10⁻⁴kg · m² (4.37 oz · in²) use the direct coupling]

● 103H7821-07 □ □

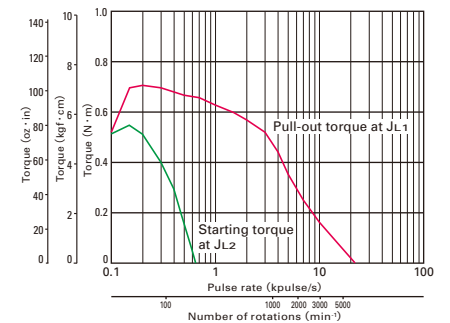

Constant current circuit
Source voltage : DC24V · operating current : 3A/phase,
2-phase energization (full-step)
J_{L1} = [0.94×10⁻⁴kg · m² (5.14 oz · in²) use the rubber coupling]
J_{L2} = [0.8×10⁻⁴kg · m² (4.37 oz · in²) use the direct coupling]

● 103H7822-01 □□

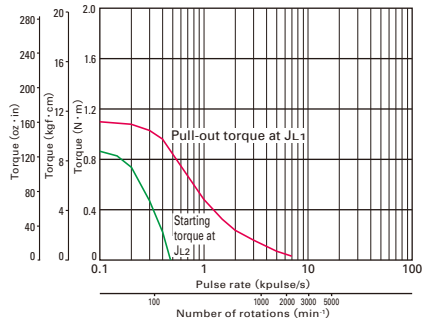

Constant current circuit

Source voltage : DC24V · operating current : 1A/phase,
2-phase energization (full-step) $J_{L1} = [7.4 \times 10^{-4} \text{kg} \cdot \text{m}^2 (40.46 \text{oz} \cdot \text{in}^2)]$ use the rubber coupling]
 $J_{L2} = [7.4 \times 10^{-4} \text{kg} \cdot \text{m}^2 (40.46 \text{oz} \cdot \text{in}^2)]$ use the direct coupling]

● 103H7822-04 □□

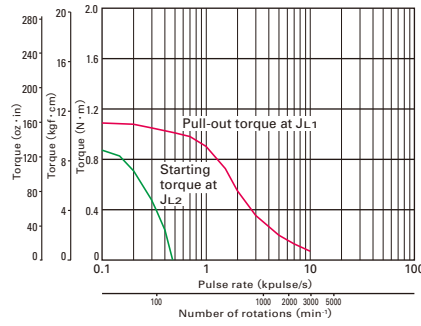

Constant current circuit

Source voltage : DC24V · operating current : 2A/phase,
2-phase energization (full-step) $J_{L1} = [7.4 \times 10^{-4} \text{kg} \cdot \text{m}^2 (40.46 \text{oz} \cdot \text{in}^2)]$ use the rubber coupling]
 $J_{L2} = [7.4 \times 10^{-4} \text{kg} \cdot \text{m}^2 (40.46 \text{oz} \cdot \text{in}^2)]$ use the direct coupling]

● 103H7822-07 □□

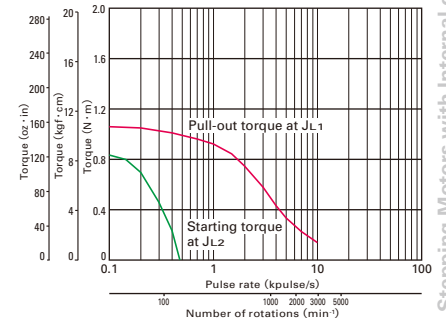

Constant current circuit

Source voltage : DC24V · operating current : 3A/phase,
2-phase energization (full-step) $J_{L1} = [7.4 \times 10^{-4} \text{kg} \cdot \text{m}^2 (40.46 \text{oz} \cdot \text{in}^2)]$ use the rubber coupling]
 $J_{L2} = [7.4 \times 10^{-4} \text{kg} \cdot \text{m}^2 (40.46 \text{oz} \cdot \text{in}^2)]$ use the direct coupling]

● 103H7823-01 □□

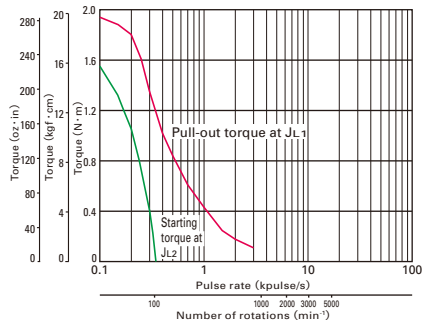

Constant current circuit

Source voltage : DC24V · operating current : 1A/phase,
2-phase energization (full-step) $J_{L1} = [7.4 \times 10^{-4} \text{kg} \cdot \text{m}^2 (40.46 \text{oz} \cdot \text{in}^2)]$ use the rubber coupling]
 $J_{L2} = [7.4 \times 10^{-4} \text{kg} \cdot \text{m}^2 (40.46 \text{oz} \cdot \text{in}^2)]$ use the direct coupling]

● 103H7823-04 □□

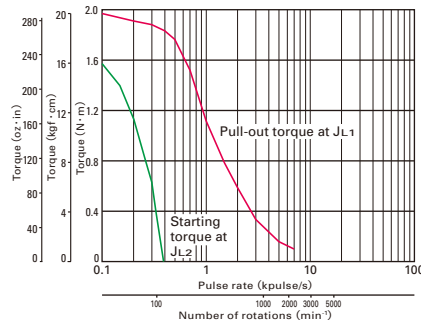

Constant current circuit

Source voltage : DC24V · operating current : 2A/phase,
2-phase energization (full-step) $J_{L1} = [7.4 \times 10^{-4} \text{kg} \cdot \text{m}^2 (40.46 \text{oz} \cdot \text{in}^2)]$ use the rubber coupling]
 $J_{L2} = [7.4 \times 10^{-4} \text{kg} \cdot \text{m}^2 (40.46 \text{oz} \cdot \text{in}^2)]$ use the direct coupling]

● 103H7823-07 □□

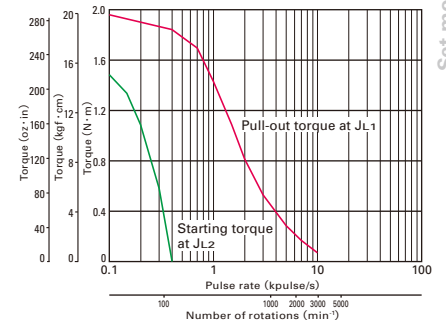

Constant current circuit

Source voltage : DC24V · operating current : 3A/phase,
2-phase energization (full-step) $J_{L1} = [7.4 \times 10^{-4} \text{kg} \cdot \text{m}^2 (40.46 \text{oz} \cdot \text{in}^2)]$ use the rubber coupling]
 $J_{L2} = [7.4 \times 10^{-4} \text{kg} \cdot \text{m}^2 (40.46 \text{oz} \cdot \text{in}^2)]$ use the direct coupling]

● 103H7821-17 □□

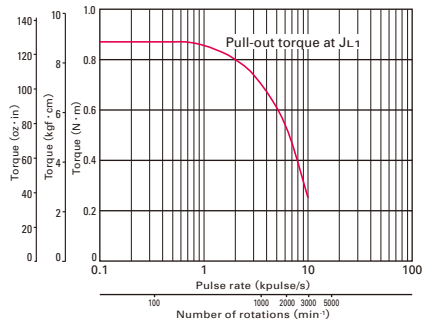

Constant current circuit

Source voltage : AC100V · operating current : 4A/phase,
2-phase energization (full-step) $J_{L1} = [2.6 \times 10^{-4} \text{kg} \cdot \text{m}^2 (14.22 \text{oz} \cdot \text{in}^2)]$ use the rubber coupling]

● 103H7821-57 □□

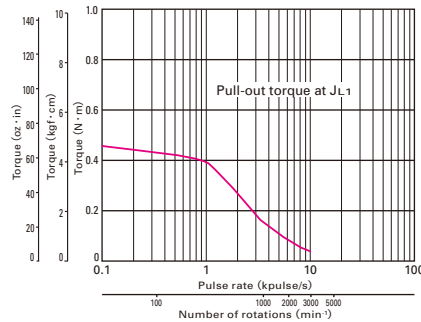

Constant current circuit

Source voltage : AC24V · operating current : 4A/phase,
2-phase energization (full-step) $J_{L1} = [2.6 \times 10^{-4} \text{kg} \cdot \text{m}^2 (14.22 \text{oz} \cdot \text{in}^2)]$ use the rubber coupling]

● 103H7822-17 □□

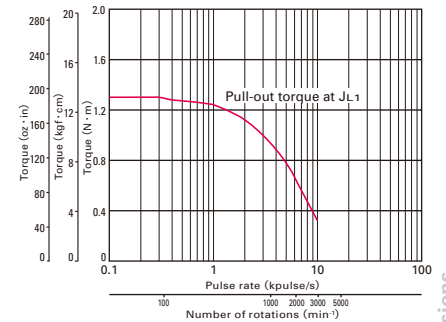

Constant current circuit

Source voltage : AC100V · operating current : 4A/phase,
2-phase energization (full-step) $J_{L1} = [2.6 \times 10^{-4} \text{kg} \cdot \text{m}^2 (14.22 \text{oz} \cdot \text{in}^2)]$ use the rubber coupling]

● 103H7822-57 □□

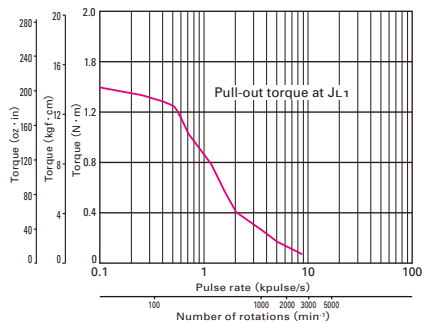

Constant current circuit

Source voltage : AC24V · operating current : 4A/phase,
2-phase energization (full-step) $J_{L1} = [7.4 \times 10^{-4} \text{kg} \cdot \text{m}^2 (40.46 \text{oz} \cdot \text{in}^2)]$ use the rubber coupling]

● 103H7823-17 □□

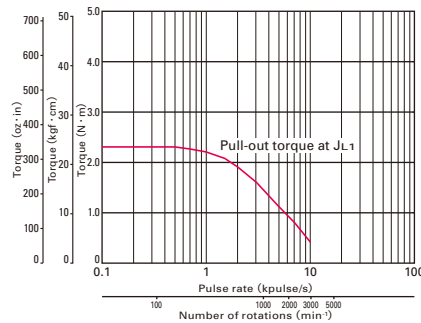

Constant current circuit

Source voltage : AC100V · operating current : 4A/phase,
2-phase energization (full-step) $J_{L1} = [7.4 \times 10^{-4} \text{kg} \cdot \text{m}^2 (40.46 \text{oz} \cdot \text{in}^2)]$ use the rubber coupling]

● 103H7823-57 □□

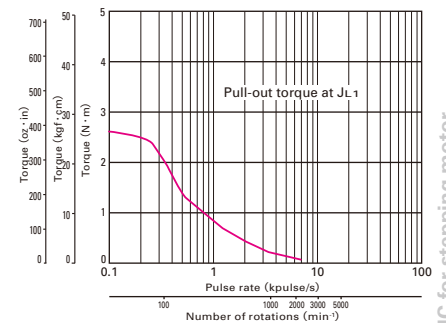

Constant current circuit

Source voltage : AC24V · operating current : 4A/phase,
2-phase energization (full-step) $J_{L1} = [7.4 \times 10^{-4} \text{kg} \cdot \text{m}^2 (40.46 \text{oz} \cdot \text{in}^2)]$ use the rubber coupling]



2-phase stepping motor

86mm sq. (3.39inch sq.)

SH286 □ /SM286 □
1.8° /step

Unipolar winding • Lead wire type

Model		Holding torque at 2-phase energization [N · m (oz · in) MIN.]	Rated current A/phase	Wiring resistance		Winding inductance mH/phase	Rotor inertia [×10 ⁻⁴ kg · m ² (oz · in ²)]	Mass (Weight) [kg (lbs)]
Single shaft	Double shafts			Ω /phase				
SH2861-0441	-0411	2.5 (354)	2	2.3	8.0	1.48 (8.09)	1.75 (3.92)	
SH2861-0941	-0911	2.5 (354)	4	0.6	2.0	1.48 (8.09)	1.75 (3.92)	
SH2862-0441	-0411	4.7 (665.6)	2	3.2	13.0	3 (16.4)	2.9 (6.5)	
SH2862-0941	-0911	4.7 (665.6)	4	0.85	3.4	3 (16.4)	2.9 (6.5)	
SH2863-0441	-0411	6.7 (948.8)	2	4.0	17.0	4.5 (24.6)	4.0 (8.96)	
SH2863-0941	-0911	6.7 (948.8)	4	0.9	4.2	4.5 (24.6)	4.0 (8.96)	

Unipolar winding • Lead wire type CE • UL model

Model		Holding torque at 2-phase energization [N · m (oz · in) MIN.]	Rated current A/phase	Wiring resistance		Winding inductance mH/phase	Rotor inertia [×10 ⁻⁴ kg · m ² (oz · in ²)]	Mass (Weight) [kg (lbs)]
Single shaft	Double shafts			Ω /phase				
SM2861-0451	-0421	2.5 (354)	2	2.3	8.0	1.48 (8.09)	1.75 (3.92)	
SM2861-0951	-0921	2.5 (354)	4	0.6	2.0	1.48 (8.09)	1.75 (3.92)	
SM2862-0451	-0421	4.8 (679.7)	2	3.2	13.0	3 (16.4)	2.9 (6.5)	
SM2862-0951	-0921	4.8 (679.7)	4	0.85	3.4	3 (16.4)	2.9 (6.5)	
SM2863-0451	-0421	6.6 (934.6)	2	4.0	17	4.5 (24.6)	4.0 (8.96)	
SM2863-0951	-0921	6.6 (934.6)	4	0.9	4.2	4.5 (24.6)	4.0 (8.96)	

Bipolar winding • Lead wire type

Model		Holding torque at 2-phase energization [N · m (oz · in) MIN.]	Rated current A/phase	Wiring resistance		Winding inductance mH/phase	Rotor inertia [×10 ⁻⁴ kg · m ² (oz · in ²)]	Mass (Weight) [kg (lbs)]
Single shaft	Double shafts			Ω /phase				
SH2861-5041	-5011	3.3 (467.3)	2	2.2	15	1.48 (8.09)	1.75 (3.92)	
SH2861-5141	-5111	3.3 (467.3)	4	0.56	3.7	1.48 (8.09)	1.75 (3.92)	
SH2861-5241	-5211	3.3 (467.3)	6	0.29	1.7	1.48 (8.09)	1.75 (3.92)	
SH2862-5041	-5011	6.4 (906.3)	2	3.2	25	3.0 (16.4)	2.9 (6.5)	
SH2862-5141	-5111	6.4 (906.3)	4	0.83	6.4	3.0 (16.4)	2.9 (6.5)	
SH2862-5241	-5211	6.4 (906.3)	6	0.36	2.8	3.0 (16.4)	2.9 (6.5)	
SH2863-5041	-5011	9 (1274.4)	2	4.0	32	4.5 (24.6)	4.0 (8.96)	
SH2863-5141	-5111	9 (1274.4)	4	1.0	7.9	4.5 (24.6)	4.0 (8.96)	
SH2863-5241	-5211	9 (1274.4)	6	0.46	3.8	4.5 (24.6)	4.0 (8.96)	

Bipolar winding • Lead wire type CE • UL model

Model		Holding torque at 2-phase energization [N · m (oz · in) MIN.]	Rated current A/phase	Wiring resistance		Winding inductance mH/phase	Rotor inertia [×10 ⁻⁴ kg · m ² (oz · in ²)]	Mass (Weight) [kg (lbs)]
Single shaft	Double shafts			Ω /phase				
SM2861-5051	-5021	3.3 (467.3)	2	2.2	15	1.48 (8.09)	1.75 (3.92)	
SM2861-5151	-5121	3.3 (467.3)	4	0.56	3.7	1.48 (8.09)	1.75 (3.92)	
SM2861-5251	-5221	3.3 (467.3)	6	0.29	1.7	1.48 (8.09)	1.75 (3.92)	
SM2862-5051	-5021	6.4 (906.3)	2	3.2	25	3.0 (16.4)	2.9 (6.5)	
SM2862-5151	-5121	6.4 (906.3)	4	0.83	6.4	3.0 (16.4)	2.9 (6.5)	
SM2862-5251	-5221	6.4 (906.3)	6	0.36	2.8	3.0 (16.4)	2.9 (6.5)	
SM2863-5051	-5021	9 (1274.4)	2	4.0	32	4.5 (24.6)	4.0 (8.96)	
SM2863-5151	-5121	9 (1274.4)	4	1.0	7.9	4.5 (24.6)	4.0 (8.96)	
SM2863-5251	-5221	9 (1274.4)	6	0.46	3.8	4.5 (24.6)	4.0 (8.96)	

Bipolar winding • Terminal block type

Model		Holding torque at 2-phase energization [N · m (oz · in) MIN.]	Rated current A/phase	Wiring resistance		Winding inductance mH/phase	Rotor inertia [×10 ⁻⁴ kg · m ² (oz · in ²)]	Mass (Weight) [kg (lbs)]
Single shaft				Ω /phase				
SM2861-5066		3.3 (467.3)	2	2.03	15	1.48 (8.09)	1.9 (4.19)	
SM2861-5166		3.3 (467.3)	4	0.52	3.7	1.48 (8.09)	1.9 (4.19)	
SM2861-5266		3.3 (467.3)	6	0.27	1.7	1.48 (8.09)	1.9 (4.19)	
SM2862-5066		6.4 (906.3)	2	3.08	25	3.0 (16.4)	3.05 (6.72)	
SM2862-5166		6.4 (906.3)	4	0.79	6.4	3.0 (16.4)	3.05 (6.72)	
SM2862-5266		6.4 (906.3)	6	0.33	2.8	3.0 (16.4)	3.05 (6.72)	
SM2863-5066		9 (1274.4)	2	3.83	32	4.5 (24.6)	4.15 (9.15)	
SM2863-5166		9 (1274.4)	4	0.96	7.9	4.5 (24.6)	4.15 (9.15)	
SM2863-5266		9 (1274.4)	6	0.48	3.8	4.5 (24.6)	4.15 (9.15)	

Pulse rate-torque characteristics

SH2861-04

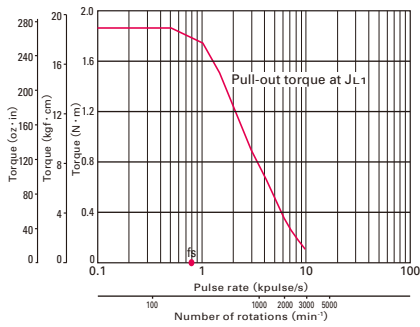

Constant current circuit
Source voltage : DC100V · operating current : 4A/phase,
2-phase energization (full-step)
 $J_{L1} = [7.4 \times 10^{-4} \text{kg} \cdot \text{m}^2 (40.46 \text{oz} \cdot \text{in}^2)]$ use the rubber coupling]

SH2862-04

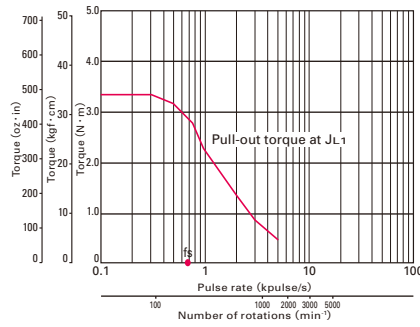

Constant current circuit
Source voltage : DC100V · operating current : 2A/phase,
2-phase energization (full-step)
 $J_{L1} = [15.3 \times 10^{-4} \text{kg} \cdot \text{m}^2 (83.65 \text{oz} \cdot \text{in}^2)]$ use the rubber coupling]

SH2863-04

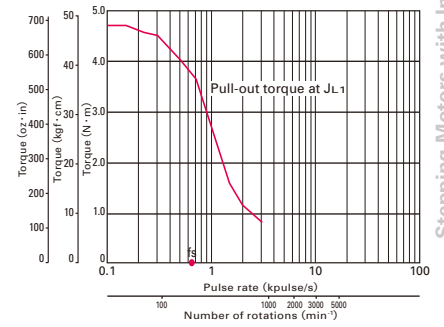

Constant current circuit
Source voltage : DC100V · operating current : 4A/phase,
2-phase energization (full-step)
 $J_{L1} = [15.3 \times 10^{-4} \text{kg} \cdot \text{m}^2 (83.65 \text{oz} \cdot \text{in}^2)]$ use the rubber coupling]

SM2861-50

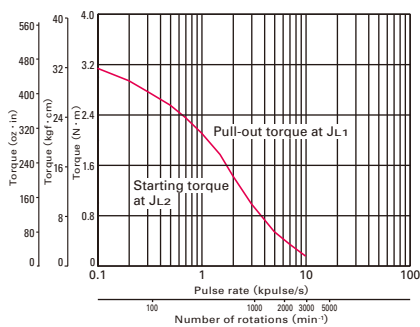

Constant current circuit
Source voltage : DC100V · operating current : 2A/phase,
2-phase energization (full-step)
 $J_{L1} = [7.4 \times 10^{-4} \text{kg} \cdot \text{m}^2 (40.46 \text{oz} \cdot \text{in}^2)]$ use the rubber coupling]

SM2861-51

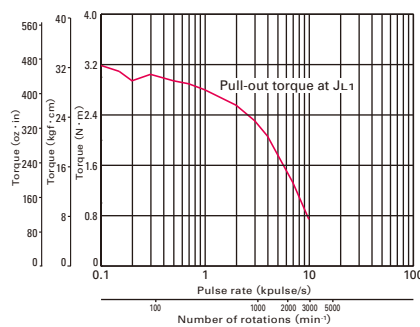

Constant current circuit
Source voltage : DC100V · operating current : 4A/phase,
2-phase energization (full-step)
 $J_{L1} = [7.4 \times 10^{-4} \text{kg} \cdot \text{m}^2 (40.46 \text{oz} \cdot \text{in}^2)]$ use the rubber coupling]

SM2861-52

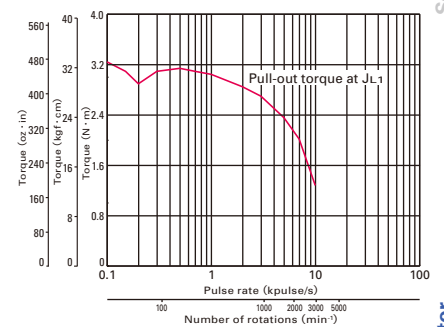

Constant current circuit
Source voltage : DC100V · operating current : 6A/phase,
2-phase energization (full-step)
 $J_{L1} = [15.3 \times 10^{-4} \text{kg} \cdot \text{m}^2 (83.65 \text{oz} \cdot \text{in}^2)]$ use the rubber coupling]

SM2862-50

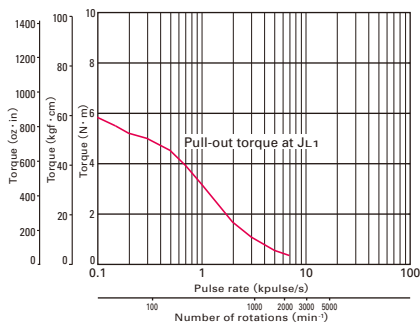

Constant current circuit
Source voltage : DC100V · operating current : 2A/phase,
2-phase energization (full-step)
 $J_{L1} = [15.3 \times 10^{-4} \text{kg} \cdot \text{m}^2 (83.65 \text{oz} \cdot \text{in}^2)]$ use the rubber coupling]

SM2862-51

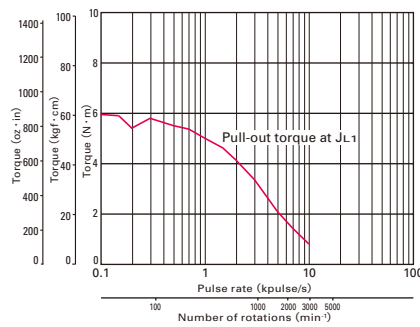

Constant current circuit
Source voltage : DC100V · operating current : 4A/phase,
2-phase energization (full-step)
 $J_{L1} = [15.3 \times 10^{-4} \text{kg} \cdot \text{m}^2 (83.65 \text{oz} \cdot \text{in}^2)]$ use the rubber coupling]

SM2862-52

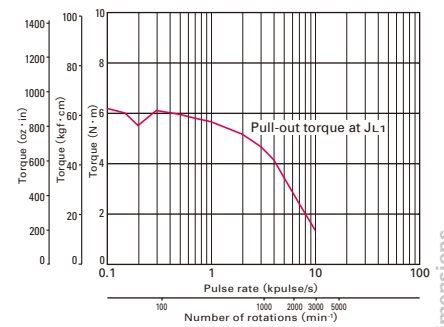

Constant current circuit
Source voltage : DC100V · operating current : 6A/phase,
2-phase energization (full-step)
 $J_{L1} = [15.3 \times 10^{-4} \text{kg} \cdot \text{m}^2 (83.65 \text{oz} \cdot \text{in}^2)]$ use the rubber coupling]

SM2863-50

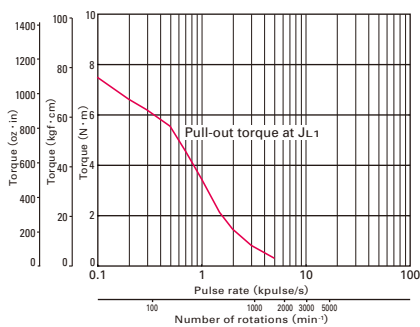

Constant current circuit
Source voltage : DC100V · operating current : 2A/phase,
2-phase energization (full-step)
 $J_{L1} = [43 \times 10^{-4} \text{kg} \cdot \text{m}^2 (235.10 \text{oz} \cdot \text{in}^2)]$ use the rubber coupling]

SM2863-51

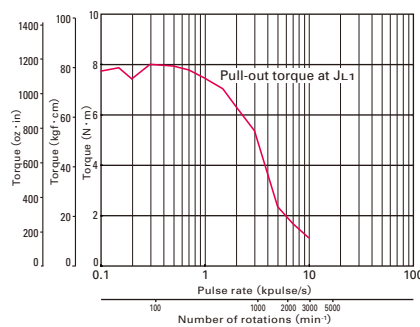

Constant current circuit
Source voltage : DC100V · operating current : 4A/phase,
2-phase energization (full-step)
 $J_{L1} = [43 \times 10^{-4} \text{kg} \cdot \text{m}^2 (235.10 \text{oz} \cdot \text{in}^2)]$ use the rubber coupling]

SM2863-52

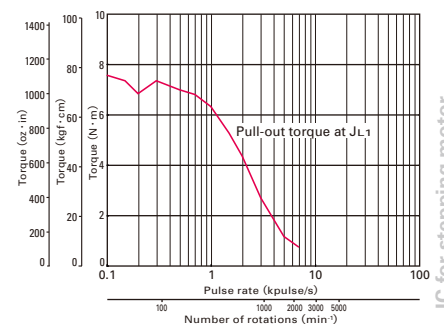

Constant current circuit
Source voltage : DC100V · operating current : 6A/phase,
2-phase energization (full-step)
 $J_{L1} = [43 \times 10^{-4} \text{kg} \cdot \text{m}^2 (235.10 \text{oz} \cdot \text{in}^2)]$ use the rubber coupling]



2-phase stepping motor

106mm cir. (4.17inch cir.)

103H8922 □
1.8° /step

Unipolar winding

Model		Holding torque at 2-phase energization	Rated current	Wiring resistance	Winding inductance	Rotor inertia	Mass (Weight)
Single shaft	Double shafts	[N · m (oz · in) MIN.]	A/phase	Ω /phase	mH/phase	[×10 ⁻⁴ kg · m ² (oz · in ²)]	[kg (lbs)]
103H89222-0941	-0911	10.8 (1529.4)	4	0.98	6.3	14.6 (79.83)	7.5 (16.53)
103H89223-0941	-0911	15.5 (2194.9)	4	1.4	9.7	22 (120.28)	10.5 (23.15)

Bipolar winding

Model		Holding torque at 2-phase energization	Rated current	Wiring resistance	Winding inductance	Rotor inertia	Mass (Weight)
Single shaft	Double shafts	[N · m (oz · in) MIN.]	A/phase	Ω /phase	mH/phase	[×10 ⁻⁴ kg · m ² (oz · in ²)]	[kg (lbs)]
103H89222-5241	-5211	13.2 (1869.2)	6	0.45	5.4	14.6 (79.83)	7.5 (16.53)
103H89223-5241	-5211	19 (2690.5)	6	0.63	8	22 (120.28)	10.5 (23.15)

Pulse rate-torque characteristics

● 103H89222-09 □ □

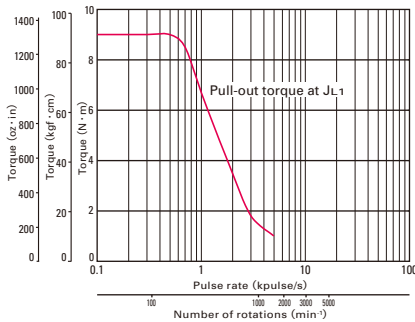

Constant current circuit
Source voltage : AC100V · operating current : 4A/phase,
2-phase energization (full-step)
J_{L1} = [43×10⁻⁴kg · m² (235.10 oz · in²)] use the rubber coupling]

● 103H89223-09 □ □

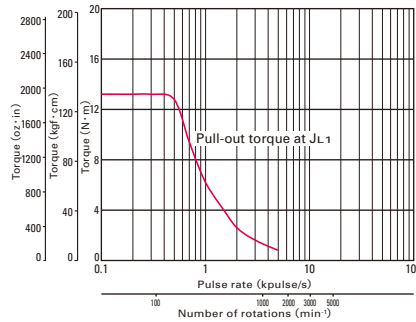

Constant current circuit
Source voltage : AC100V · operating current : 4A/phase,
2-phase energization (full-step)
J_{L1} = [43×10⁻⁴kg · m² (235.10 oz · in²)] use the rubber coupling]

● 103H89222-52 □ □

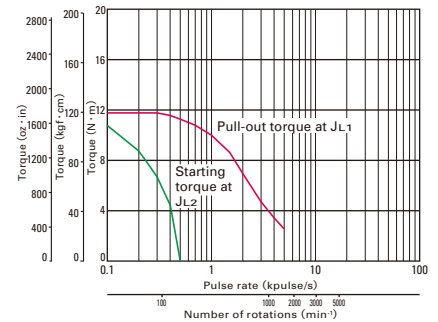

Constant current circuit
Source voltage : AC100V · operating current : 6A/phase,
2-phase energization (full-step)
J_{L1} = [43×10⁻⁴kg · m² (235.10 oz · in²)] use the rubber coupling]
J_{L2} = [43×10⁻⁴kg · m² (235.10 oz · in²)] use the rubber coupling]

● 103H89223-52 □ □

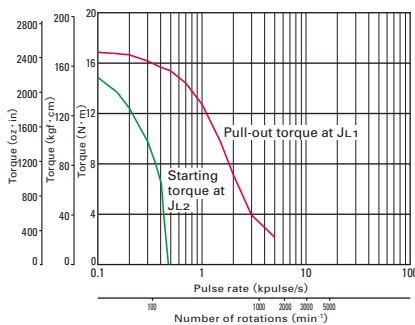

Constant current circuit
Source voltage : AC100V · operating current : 6A/phase,
2-phase energization (full-step)
J_{L1} = [43×10⁻⁴kg · m² (235.10 oz · in²)] use the rubber coupling]
J_{L2} = [43×10⁻⁴kg · m² (235.10 oz · in²)] use the rubber coupling]

2-phase stepping motor

56mm sq. (2.20inch sq.)

103H712 □
CE marking
1.8° /step



Unipolar winding

Model		Holding torque at 2-phase energization		Rated current	Wiring resistance	Winding inductance	Rotor inertia	Mass (Weight)
Single shaft	Double shafts	[N · m (oz · in) MIN.]		A/phase	Ω /phase	mH/phase	[×10 ⁻⁴ kg · m ² (oz · in ²)]	[kg (lbs)]
103H7121-6140	-6110	0.39 (55.2)		1	4.8	8	0.1 (0.55)	0.47 (1.04)
103H7121-6740	-6710	0.39 (55.2)		3	0.6	0.8	0.1 (0.55)	0.47 (1.04)
103H7123-6140	-6110	0.83 (117.5)		1	6.7	15	0.21 (1.15)	0.65 (1.43)
103H7123-6740	-6710	0.78 (110.5)		3	0.77	1.58	0.21 (1.15)	0.65 (1.43)
103H7126-6140	-6110	1.27 (179.8)		1	8.6	19	0.36 (1.97)	0.98 (2.16)
103H7126-6740	-6710	1.27 (179.8)		3	0.9	2.2	0.36 (1.97)	0.98 (2.16)

Pulse rate-torque characteristics

● 103H7121-61 □ □

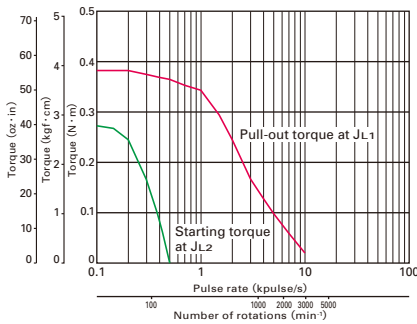

Constant current circuit

Source voltage : DC24V · operating current : 1A/phase,
2-phase energization (full-step)
 $J_{L1} = [0.94 \times 10^{-4} \text{kg} \cdot \text{m}^2 (5.14 \text{oz} \cdot \text{in}^2)]$ use the rubber coupling]
 $J_{L2} = [0.8 \times 10^{-4} \text{kg} \cdot \text{m}^2 (4.37 \text{oz} \cdot \text{in}^2)]$ use the direct coupling]

● 103H7121-67 □ □

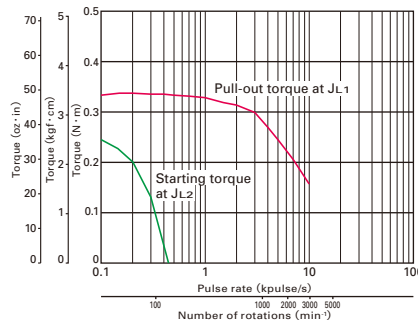

Constant current circuit

Source voltage : DC24V · operating current : 3A/phase,
2-phase energization (full-step)
 $J_{L1} = [0.94 \times 10^{-4} \text{kg} \cdot \text{m}^2 (5.14 \text{oz} \cdot \text{in}^2)]$ use the rubber coupling]
 $J_{L2} = [0.8 \times 10^{-4} \text{kg} \cdot \text{m}^2 (4.37 \text{oz} \cdot \text{in}^2)]$ use the direct coupling]

● 103H7123-61 □ □

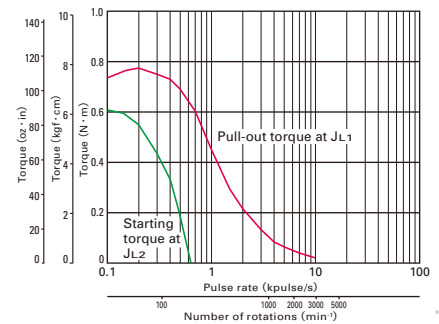

Constant current circuit

Source voltage : DC24V · operating current : 1A/phase,
2-phase energization (full-step)
 $J_{L1} = [0.94 \times 10^{-4} \text{kg} \cdot \text{m}^2 (5.14 \text{oz} \cdot \text{in}^2)]$ use the rubber coupling]
 $J_{L2} = [0.8 \times 10^{-4} \text{kg} \cdot \text{m}^2 (4.37 \text{oz} \cdot \text{in}^2)]$ use the direct coupling]

● 103H7123-67 □ □

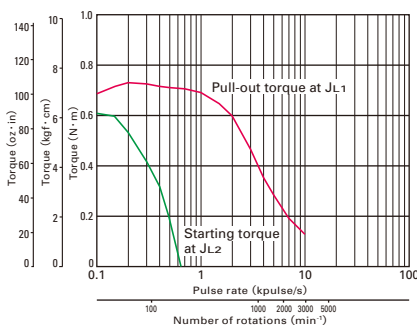

Constant current circuit

Source voltage : DC24V · operating current : 3A/phase,
2-phase energization (full-step)
 $J_{L1} = [0.94 \times 10^{-4} \text{kg} \cdot \text{m}^2 (5.14 \text{oz} \cdot \text{in}^2)]$ use the rubber coupling]
 $J_{L2} = [0.8 \times 10^{-4} \text{kg} \cdot \text{m}^2 (4.37 \text{oz} \cdot \text{in}^2)]$ use the direct coupling]

● 103H7126-61 □ □

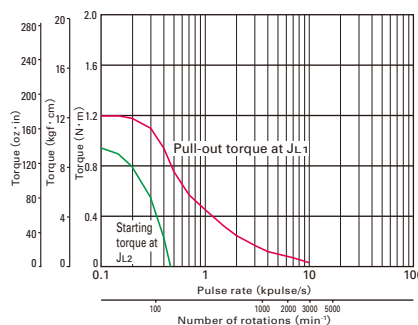

Constant current circuit

Source voltage : DC24V · operating current : 1A/phase,
2-phase energization (full-step)
 $J_{L1} = [2.6 \times 10^{-4} \text{kg} \cdot \text{m}^2 (14.22 \text{oz} \cdot \text{in}^2)]$ use the rubber coupling]
 $J_{L2} = [2.6 \times 10^{-4} \text{kg} \cdot \text{m}^2 (14.22 \text{oz} \cdot \text{in}^2)]$ use the direct coupling]

● 103H7126-67 □ □

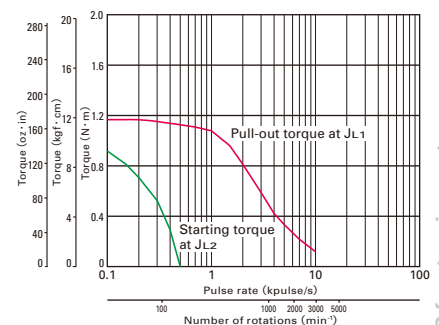

Constant current circuit

Source voltage : DC24V · operating current : 3A/phase,
2-phase energization (full-step)
 $J_{L1} = [2.6 \times 10^{-4} \text{kg} \cdot \text{m}^2 (14.22 \text{oz} \cdot \text{in}^2)]$ use the rubber coupling]
 $J_{L2} = [2.6 \times 10^{-4} \text{kg} \cdot \text{m}^2 (14.22 \text{oz} \cdot \text{in}^2)]$ use the direct coupling]



2-phase stepping motor

86mm cir. (3.39inch cir.)

103H822 □
CE marking
1.8° /step



Bipolar winding

Model		Holding torque at 2-phase energization	Rated current	Wiring resistance	Winding inductance	Rotor inertia	Mass (Weight)
Single shaft	Double shafts	[N · m (oz · in) MIN.]	A/phase	Ω /phase	mH/phase	[×10 ⁻⁴ kg · m ² (oz · in ²)]	[kg (lbs)]
103H8221-6240	-6210	2.74 (388.0)	6	0.3	1.65	1.45 (7.93)	1.5 (3.31)
103H8222-6340	-6310	5.09 (720.8)	6	0.35	2.7	2.9 (15.86)	2.5 (5.51)
103H8223-6340	-6310	7.44 (1053.6)	6	0.45	3.4	4.4 (24.06)	3.5 (7.72)

Pulse rate-torque characteristics

● 103H8221-62 □□

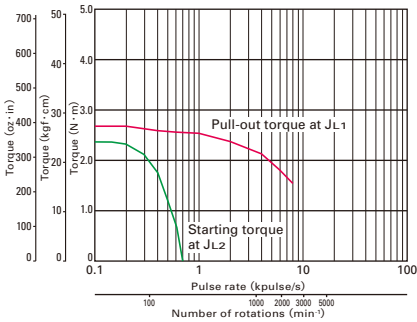

Constant current circuit
Source voltage : AC100V · operating current : 6A/phase,
2-phase energization (full-step)
 $J_{L1} = [7.4 \times 10^{-4} \text{kg} \cdot \text{m}^2 (40.46 \text{oz} \cdot \text{in}^2)]$ use the rubber coupling]
 $J_{L2} = [7.4 \times 10^{-4} \text{kg} \cdot \text{m}^2 (40.46 \text{oz} \cdot \text{in}^2)]$ use the direct coupling]

● 103H8222-63 □□

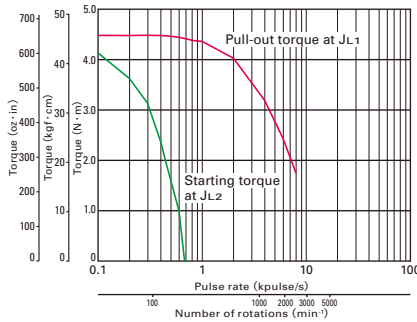

Constant current circuit
Source voltage : AC100V · operating current : 6A/phase,
2-phase energization (full-step)
 $J_{L1} = [15.3 \times 10^{-4} \text{kg} \cdot \text{m}^2 (83.65 \text{oz} \cdot \text{in}^2)]$ use the rubber coupling]
 $J_{L2} = [15.3 \times 10^{-4} \text{kg} \cdot \text{m}^2 (83.65 \text{oz} \cdot \text{in}^2)]$ use the direct coupling]

● 103H8223-63 □□

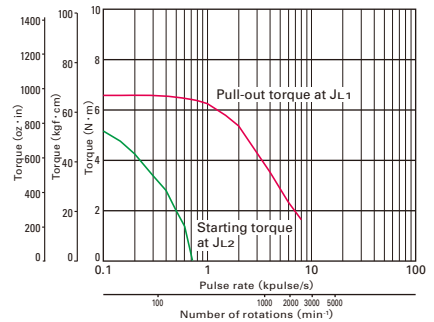

Constant current circuit
Source voltage : AC100V · operating current : 6A/phase,
2-phase energization (full-step)
 $J_{L1} = [43 \times 10^{-4} \text{kg} \cdot \text{m}^2 (235.10 \text{oz} \cdot \text{in}^2)]$ use the rubber coupling]
 $J_{L2} = [43 \times 10^{-4} \text{kg} \cdot \text{m}^2 (235.10 \text{oz} \cdot \text{in}^2)]$ use the direct coupling]



2-phase stepping motor

106mm cir. (4.17inch cir.)

103H8922 □

CE marking

1.8° /step



Bipolar winding

Model		Holding torque at 2-phase energization	Rated current	Wiring resistance	Winding inductance	Rotor inertia	Mass (Weight)
Single shaft	Double shafts	[N · m (oz · in) MIN.]	A/phase	Ω /phase	mH/phase	[×10 ⁻⁴ kg · m ² (oz · in ²)]	[kg (lbs)]
103H89222-6341	-6311	13.2 (1869.2)	6	0.45	5.4	14.6 (79.83)	7.5 (16.53)
103H89223-6341	-6311	19 (2690.5)	6	0.63	8	22 (120.28)	10.5 (23.15)

Pulse rate-torque characteristics

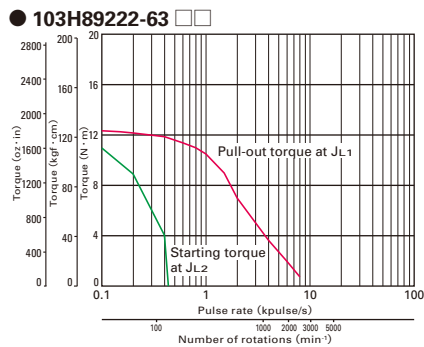

Constant current circuit
 Source voltage : AC100V · operating current : 6A/phase,
 2-phase energization (full-step)
 $J_{L1} = [43 \times 10^{-4} \text{kg} \cdot \text{m}^2 (235.10 \text{oz} \cdot \text{in}^2)]$ use the rubber coupling]
 $J_{L2} = [43 \times 10^{-4} \text{kg} \cdot \text{m}^2 (235.10 \text{oz} \cdot \text{in}^2)]$ use the direct coupling]

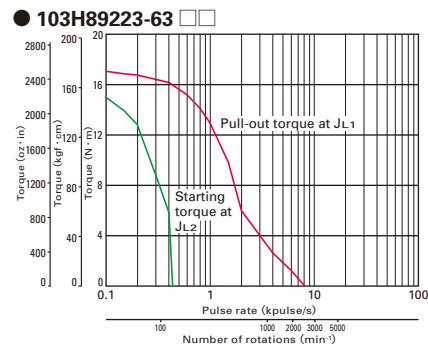

Constant current circuit
 Source voltage : AC100V · operating current : 6A/phase,
 2-phase energization (full-step)
 $J_{L1} = [43 \times 10^{-4} \text{kg} \cdot \text{m}^2 (235.10 \text{oz} \cdot \text{in}^2)]$ use the rubber coupling]
 $J_{L2} = [43 \times 10^{-4} \text{kg} \cdot \text{m}^2 (235.10 \text{oz} \cdot \text{in}^2)]$ use the direct coupling]

Standard models

Motor type	H series motor
Model number	103H52 □□ /103H67 □□ /103H71 □□ /103H78 □□
Insulation class	Class B (130°C)
Withstand voltage	□42 (□1.65inch) : AC500V 50/60Hz for 1 minute, □50 (□1.97inch)·□56 (□2.20inch)·□60 (□2.36inch) : AC1000V 50/60Hz for 1 minute
Insulation resistance	100M ohm MIN. against DC500V
Vibration resistance	Amplitude of 1.52mm (0.06inch) (P-P) at frequency range 10 to 500Hz for 15 minutes sweep time along X, Y, and Z axes for 12 times.
Impact resistance	490m/s ² of acceleration for 11 ms with half-sine wave applying three times for X, Y, and Z axes each, 18 times in total.
Operating ambient temperature	-10°C to 50°C
Operating ambient humidity	90%MAX. : 40°C MAX., 57%MAX. : 50°C MAX., 35%MAX. : 60°C MAX. (no condensation)

Motor type	SH series motor
Motor model number	SH228 □□ , SH353 □□ , SH142 □□ , SH160 □□ , SH286 □ ,
Insulation class	Class B (130°C)
Withstand voltage	□28 (□1.10inch)·□35 (□1.38inch)·□42 (□1.65inch) : AC500V 50/60Hz for 1 minute, □60 (□2.36inch) / □86 (□3.38inch) : AC1000V 50/60Hz for 1 minute
Insulation resistance	100M ohm MIN. against DC500V
Vibration resistance	Amplitude of 1.52mm (0.06inch) (P-P) at frequency range 10 to 500Hz for 15 minutes sweep time along X, Y, and Z axes for 12 times.
Impact resistance	490m/s ² of acceleration for 11 ms with half-sine wave applying three times for X, Y, and Z axes each, 18 times in total.
Operating ambient temperature	-10°C to 50°C
Operating ambient humidity	90%MAX. : 40°C MAX., 57%MAX. : 50°C MAX., 35%MAX. : 60°C MAX. (no condensation)

Motor type	SM series motor
Model number	SM286□
Type	S1 (continuous operation)
Insulation class	Class F (+155°C)
Operation altitude	1000m (3280 feet) MAX above sea level
Withstand voltage	□86mm (□3.39inch) : AC1500V 50/60Hz for 1 minute
Insulation resistance	100M ohm MIN. against DC500V
Protection grade	IP43
Vibration resistance	Amplitude of 1.52mm (0.06inch) (P-P) at frequency range 10 to 500Hz for 15 minutes sweep time along X, Y, and Z axes for 12 times.
Impact resistance	490m/s ² of acceleration for 11 ms with half-sine wave applying three times for X, Y, and Z axes each, 18 times in total.
Ambient operation temperature	-10 to +50°C
Ambient operation humidity	90% MAX. at less than 40°C, 57% MAX. at less than 50°C , 35% MAX. at 60°C (no condensation)

Allowable radial / thrust load

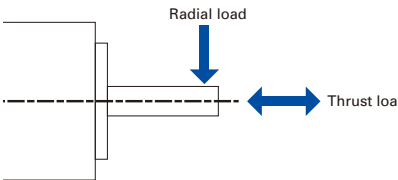

Frange size	Model number	Distance from end of shaft : mm (inch)				Thrust load N (lbs)
		0	5 (0.20)	10 (0.39)	15 (0.59)	
□28mm (□1.10inch)	SH228 □	42 (9)	48 (10)	56 (12)	66 (14)	3 (0.67)
□35mm (□1.38inch)	SH353 □	40 (8)	50 (11)	67 (15)	98 (22)	10 (2.25)
□42mm (□1.65inch)	103H52 □□ 103-59 □ SH142 □	22 (4)	26 (5)	33 (7)	46 (10)	10 (2.25)
□50mm (□1.97inch)	103H670 □	71 (15)	87 (19)	115 (25)	167 (37)	15 (3.37)
□56mm (□2.20inch)	103H712 □ 103H7128	52 (11)	65 (14)	85 (19)	123 (27)	15 (3.37)
□60mm (□2.36inch)	103H782 □ SH160 □	70 (15)	87 (19)	114 (25)	165 (37)	20 (4.50)
□86mm (□3.39inch)	SM286 □ SH286 □	167 (37)	193 (43)	229 (51)	280 (62)	60 (13.488)
φ 86mm (φ 3.39inch)	103H822 □	191 (42)	234 (52)	301 (67)	421 (93)	60 (13.488)
φ 106mm (φ 4.17inch)	103H8922 □	321 (72)	356 (79)	401 (90)	457 (101)	100 (22.48)

CE marked models

Model Number	103H712 □	103H822 □ / 103H8922 □
Rated voltage	12-200VDC	12-300VDC
Applied standards (Low voltage directive)	EN60034-1, IEC34-5 (EN60034-5), EN60204-1, EN60950, EN61010-1	
Operation type	S1 (continuous rating)	
Protection grade	IP43	
Device category	Class I	
Operation environment	Pollution degree 2	
Insulation class	Class B (130°C)	
Insulation resistance	100M ohm MIN. against DC500V	
Withstand voltage	□56mm (□2.2inch) : AC1500V 50/60Hz for 1 minute φ 86mm (φ 3.39inch) φ 106mm (φ 4.17inch) : AC1600V 50/60Hz for 1 minute	
Ambient operation temperature	-10 to +50°C	
Ambient operation humidity	90% MAX. at less than 40°C, 57% MAX. at less than 50°C , 35% MAX. at 60°C (no condensation)	
Winding temperature rise	80K MAX. (Based on Sanyo Denki standard)	

Internal Wiring and Rotation Direction

Unipolar winding

● 103H52 □ Connector type

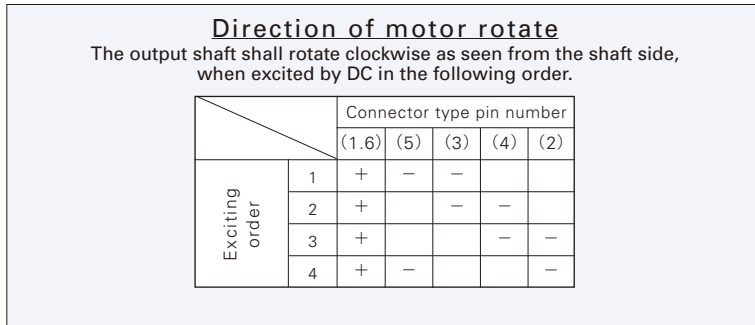
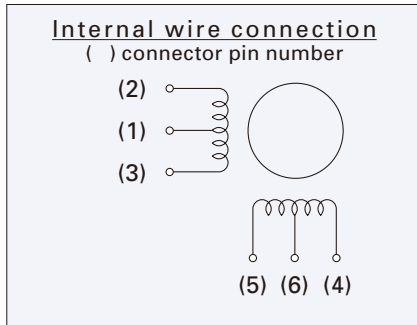

● 103H782 □ Connector type

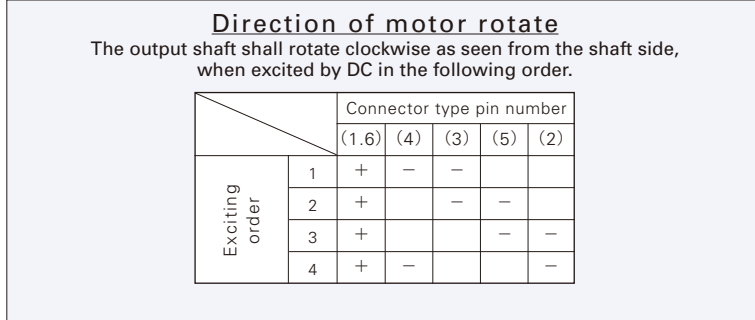
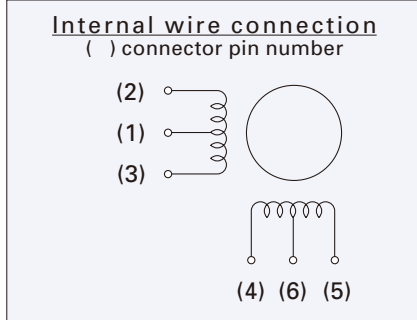

● Lead wire type

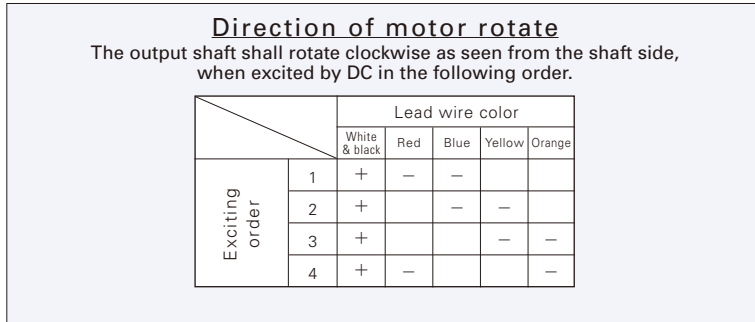
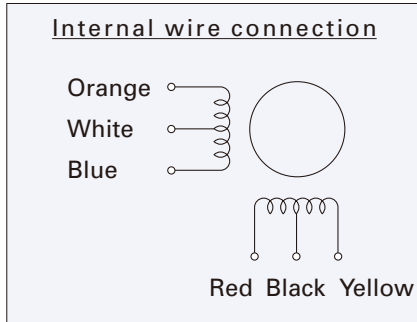

Bipolar winding

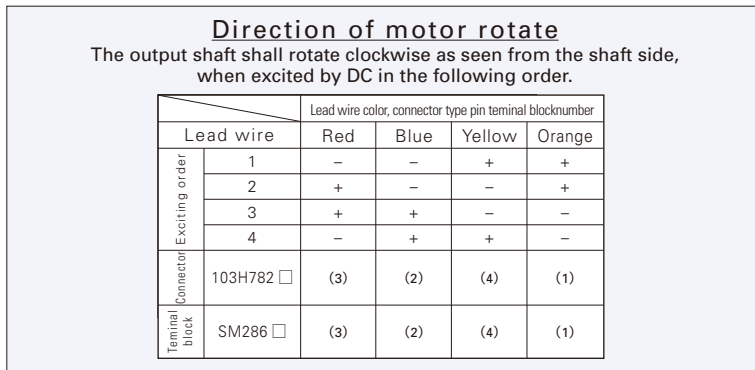
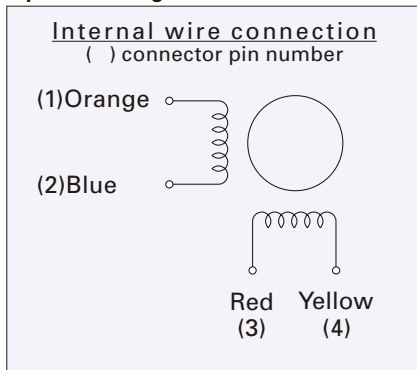

Dimensions

Motors [Unit: mm (inch)]

56mm (2.20inch)

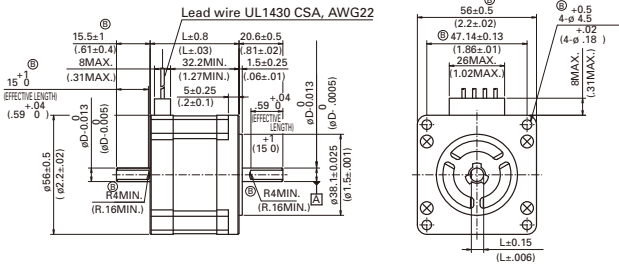

Lead wire type

	Set part number	Motor model number	Motor length : mm (inch)	Cable type
Bipolar	DB16H711 △	103H7121-57 △ 0	41.8 (1.65)	Lead wire
	DB16H713 △	103H7123-57 △ 0	53.8 (2.12)	Lead wire
	DB16H716 △	103H7126-57 △ 0	75.8 (2.98)	Lead wire
	—	103H7121-56 △ 0	41.8 (1.65)	Lead wire
	—	103H7121-58 △ 0	41.8 (1.65)	Lead wire
	—	103H7123-56 △ 0	53.8 (2.12)	Lead wire
	—	103H7123-58 △ 0	53.8 (2.12)	Lead wire
	—	103H7126-56 △ 0	75.8 (2.98)	Lead wire
	—	103H7126-58 △ 0	75.8 (2.98)	Lead wire
	—	103H7128-56 △ 0	94.8 (3.73)	Lead wire
—	103H7128-57 △ 0	94.8 (3.73)	Lead wire	
—	103H7128-58 △ 0	94.8 (3.73)	Lead wire	

60mm (2.36inch)

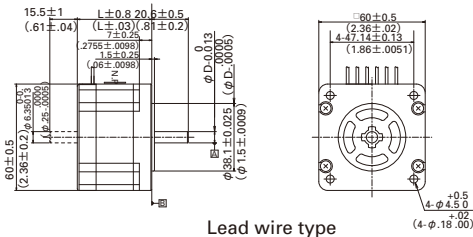

	Set part number	Motor model number	Motor length : mm (inch)	Cable type
Unipolar	—	SH1601-04 △ 0	42 (1.65)	Lead wire
	—	SH1602-04 △ 0	54 (2.13)	Lead wire
	—	SH1603-04 △ 0	76 (2.99)	Lead wire
Bipolar	DB16S161 △	SH1601-52 △ 0	42 (1.65)	Lead wire
	DB16S162 △	SH1602-52 △ 0	54 (2.13)	Lead wire
	DB16S163 △	SH1603-52 △ 0	76 (2.99)	Lead wire

60mm (2.36inch)

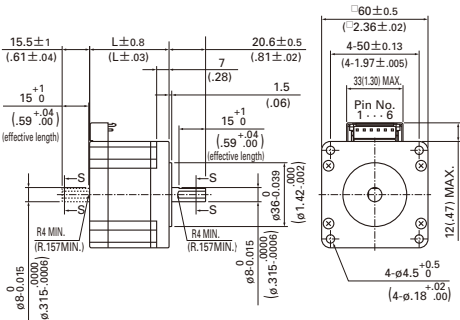

Connector type

	Set part number	Motor model number	Motor length : mm (inch)	Cable type
Unipolar	—	103H7821-01 △ 0	44.8 (1.76)	Connector
	—	103H7821-04 △ 0	44.8 (1.76)	Connector
	—	103H7821-07 △ 0	44.8 (1.76)	Connector
	—	103H7822-01 △ 0	53.8 (2.12)	Connector
	—	103H7822-04 △ 0	53.8 (2.12)	Connector
	—	103H7822-07 △ 0	53.8 (2.12)	Connector
	—	103H7823-01 △ 0	85.8 (3.38)	Connector
	—	103H7823-04 △ 0	85.8 (3.38)	Connector
Bipolar	DB16H781 △	103H7821-57 △ 0	44.8 (1.76)	Connector
	DB16H782 △	103H7822-57 △ 0	53.8 (2.12)	Connector
	DB16H783 △	103H7823-57 △ 0	85.8 (3.38)	Connector
	—	103H7821-17 △ 0	44.8 (1.76)	Connector
	—	103H7822-17 △ 0	53.8 (2.12)	Connector
—	103H7823-17 △ 0	85.8 (3.38)	Connector	

86mm (3.39inch)

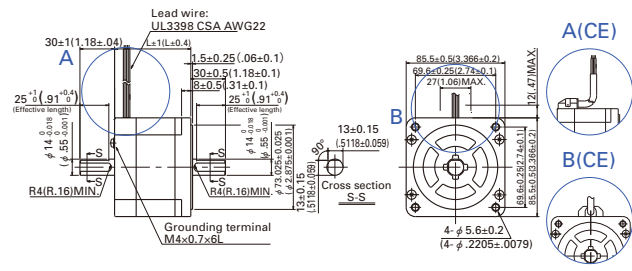

Lead wire type

CE type

	Set part number	Motor model number	Motor length : mm (inch)	Cable type
Unipolar	—	SH2861-04 △ 1	66 (2.6)	Lead wire
	—	SH2862-04 △ 1	96.5 (3.8)	Lead wire
	—	SH2863-04 △ 1	127 (5)	Lead wire
Bipolar	—	SM2861-50 ◇ 1	66 (2.6)	Lead wire (CE)
	—	SM2861-51 ◇ 1	66 (2.6)	Lead wire (CE)
	—	SM2861-52 ◇ 1	66 (2.6)	Lead wire (CE)
	—	SM2862-50 ◇ 1	96.5 (3.8)	Lead wire (CE)
	—	SM2862-51 ◇ 1	96.5 (3.8)	Lead wire (CE)
	—	SM2862-52 ◇ 1	96.5 (3.8)	Lead wire (CE)
—	SM2863-50 ◇ 1	127 (5)	Lead wire (CE)	
—	SM2863-51 ◇ 1	127 (5)	Lead wire (CE)	
—	SM2863-52 ◇ 1	127 (5)	Lead wire (CE)	

Model number	Shaft diameter(D)	Deut thickness(L)
103H7121-□□□□		
103H7123-□□□□	φ 6.35	5.8
103H7126-□□□□		
103H7128-□□□□	φ 8	7.5
Model number	Shaft diameter(D)	Deut thickness(L)
SH1601-□□□□		
SH1602-□□□□	φ 6.35	5.8
SH1603-□□□□	φ 8	7.5

△ : Motor shaft specification code

Motor shaft spec	Set type code	Motor type code
Single shaft	S	4
Double shafts	D	1

◇ : Motor shaft specification code

Motor shaft spec	Set type code	Motor type code
Single shaft	S	5
Double shafts	D	2

φ 86mm (φ 3.39inch)

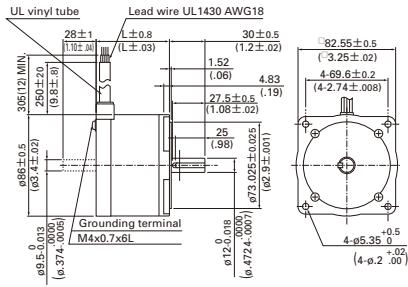

Lead wire type

	Set part number	Motor model number	Motor length : mm (inch)	Cable type
Bipolar	—	103H8221-62 △ 0	62 (3.31)	Lead wire (CE)
	—	103H8222-63 △ 0	92.2 (5.51)	Lead wire (CE)
	—	103H8223-63 △ 0	125.9(7.72)	Lead wire (CE)
	—	103H8223-63 △ 0	125.9(7.72)	Lead wire (CE)

□ 86mm (□ 3.39inch)

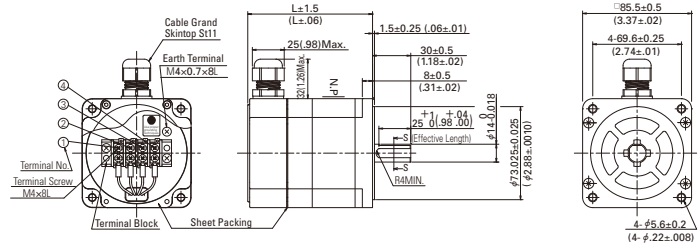

Terminal block type

	Set part number	Motor model number	Motor length : mm (inch)	Cable type
Terminal block	—	SM2861-5066	97.9 (3.9)	Terminal block
	—	SM2861-5166	97.9 (3.9)	Terminal block
	—	SM2861-5266	97.9 (3.9)	Terminal block
	—	SM2862-5066	128.4 (5.1)	Terminal block
	—	SM2862-5166	128.4 (5.1)	Terminal block
	—	SM2862-5266	128.4 (5.1)	Terminal block
	—	SM2863-5066	158.8 (6.3)	Terminal block
	—	SM2863-5166	158.8 (6.3)	Terminal block
—	SM2863-5266	158.8 (6.3)	Terminal block	

φ 106mm (φ 4.17inch)

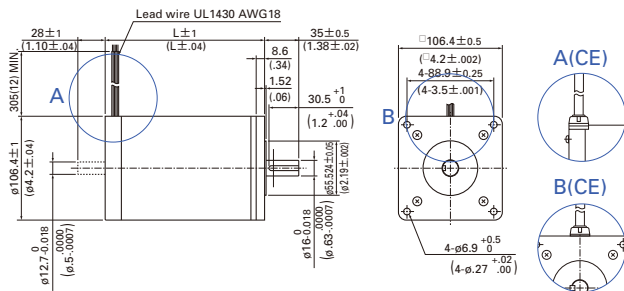

Lead wire type

CE type

	Set part number	Motor model number	Motor length : mm (inch)	Cable type
Unipolar	—	103H89222-09 △ 1	163.3 (6.4)	Lead wire
	—	103H89223-09 △ 1	221.3 (8.7)	Lead wire
	—	103H89222-52 △ 1	163.3 (6.4)	Lead wire
Bipolar	—	103H89223-52 △ 1	221.3 (8.7)	Lead wire (CE)
	—	103H89222-63 △ 1	163.3 (6.4)	Lead wire (CE)
	—	103H89223-63 △ 1	221.3 (8.7)	Lead wire

△ : Motor shaft specification code

Motor shaft spec	Set type code	Motor type code
Single shaft	S	4
Double shafts	D	1

▽ : Motor shaft specification code

Motor shaft spec	Set type code	Motor type code
Single shaft	S	7
Double shafts	D	3

Drivers [Unit: mm (inch)]

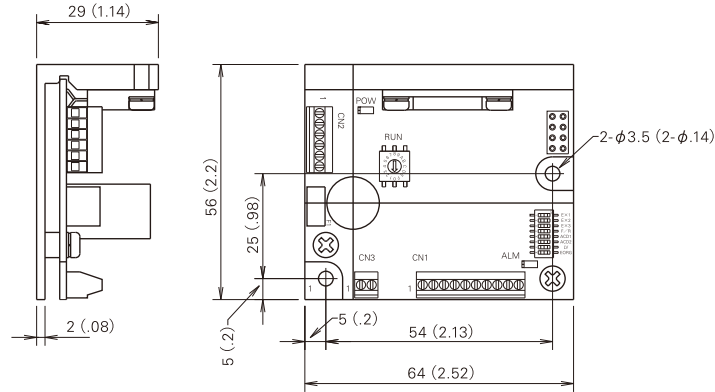

Safety standards

driver

UL	Acquired standards		File No.	Standard part
	UL		E179775	UL508C
	UL for Canada			
CE (TÜV)	Directives	Category	Name	Standard part
	Low-voltage directives	—	—	EN61010-1
		EMC directives	Emission	Terminal disturbance voltage
	Electromagnetic radiation disturbance			EN55011-A
	Immunity		ESD (Electrostatic discharge)	EN61000-4-2
			RS (Radio-frequency amplitude modulated electromagnetic field)	EN61000-4-3
Fast transients		EN61000-4-4		
		Surges	EN61000-4-6	

SM series motor(UL/CE),H series motor(CE)

UL	Acquired standards		File No.	Standard part
	UL		E208878	EN-60034-1
	UL for Canada			
CE	Standard category			
	Low-voltage directives			IEC34-5
				(EN-60034-5)

- EMC characteristics may vary depending on the configuration of the users' control panel, which contains the driver or stepping motor, or the arrangement and wiring of other electrical devices. Parts for EMC noise suppression like noise filters and toroidal type ferrite cores may be required depending on circumstances.
- Validation test of F series driver has been performed for low-voltage EMC directives at TÜV (TÜV product service) for self-declaration of CE marking.

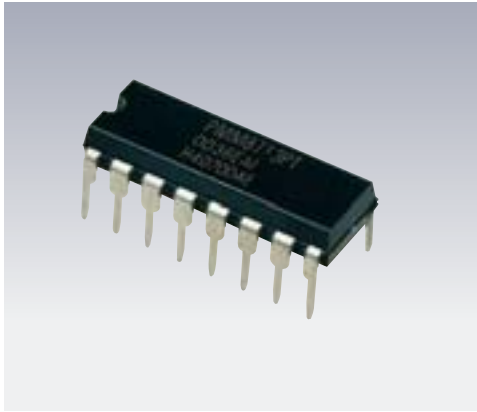

Universal controller IC for the 2-phase stepping motor drive

PMM8713PT

Characteristics

- Universal controller : The following 3 types of energization mode can be selected by switching at the energization mode switching terminal
1EX/1-2EX/2EX
- Source voltage : $V_{CC} = 4.5$ to $5.5V$
- High output current : $24mA$ MIN. (sink, source)
- High noise margin : Schmitt trigger circuit is incorporated for the all input terminals.
- 2 types of pulse input : 2 input mode (CW, CCW input mode)
Pulse and direction mode (CK, U/D input mode)
- Excited status verification monitor : Outputs the monitor signal of the controller status.

Maximum Rating ($T_a=25^{\circ}C$)

Item	Symbol	Rating	Unit
Source voltage	V_{CC}	-0.3 to 7	V
Output current ϕn	"H" level $I_{OH} \phi$	-35	mA
	"L" level $I_{OL} \phi$	35	
Output current C_o, E_m	"H" level I_{OH}		μA
	"L" level I_{OL}		
Input voltage	V_{IN}	-0.3 to $V_{CC} + 0.3$	V
Input current	I_{IN}	± 10	mA
operating current	T_{opr}	-20 to 85	$^{\circ}C$
Conservation temperature	T_{stg}	-40 to 125	$^{\circ}C$

Recommended Operating Conditions ($T_a=-20$ to $85^{\circ}C$)

Item	Symbol	Rating	Rating			Unit
			MIN.	Standard	MAX.	
Source voltage	V_{CC}	4.5	-	-	5.5	V
Output current ϕn	"H" level $I_{OH} \phi$	-24	-	-	-	mA
	"L" level $I_{OL} \phi$	24	-	-	-	
Output current C_o, E_m	"H" level I_{OH}	-2	-	-	-	mA
	"L" level I_{OL}	2	-	-	-	
Input voltage	V_{IN}	0	-	-	V_{CC}	V

Dimensions [Unit : mm (inch)]

Pin No.	Name	Function
1.	C_U	Input pulse UP clock input
2.	C_D	Input pulse DOWN clock input
3.	C_k	Input pulse clock input
4.	U/D	Rotation direction conversion energization mode switching input
5.	E_A	energization mode switching input
6.	E_B	energization mode switching input
7.	ϕc	energization mode switching input
8.	V_{SS}	GND
9.	R	Reset input
10.	$\phi 4$	$\phi 4$ output
11.	$\phi 3$	$\phi 3$ output
12.	$\phi 2$	$\phi 2$ output
13.	$\phi 1$	$\phi 1$ output
14.	E_m	energization monitor output
15.	C_o	Input pulse monitor output
16.	V_{CC}	4.5 to 5.5V

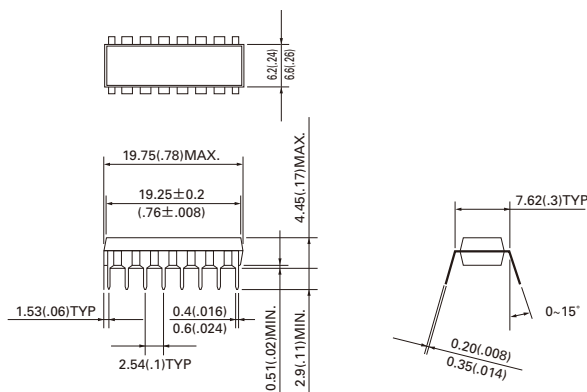

Electrical Characteristics

Direct current characteristics (Ta = -20 to 85°C)

Item	Symbol	Condition VCC[V]		Standard value			Unit
				MIN.	Standard	MAX.	
Input voltage	"H" level	V _{IH}	5	3.5	—	—	V
	"L" level	V _{IL}	5	—	—	1.5	V
Output voltage	"H" level	V _{OH}	5 V _H =5V V _L =0V I _{OH} =0	4.9	—	—	V
	"L" level	V _{OL}	5 V _H =5V V _L =0V I _{OH} =0	—	—	0.1	V
Output current φ 1 to φ 4	"H" level	I _{OH}	5 V _H =5V V _L =0V V _{OUT} =2.4V	-24	—	—	mA
	"L" level	I _{OL}	5 V _H =5V V _L =0V V _{OUT} =0.4V	24	—	—	mA
Output current C _O , E _M	"H" level	I _{OH}	5 V _H =5V V _L =0V V _{OUT} =2.4V	-2	—	—	mA
	"L" level	I _{OL}	5 V _H =5V V _L =0V V _{OUT} =0.4V	2	—	—	mA
Input current	I	5	—	—	10	—	μA
Static current consumption	I _{CC}	5	V _H =5V V _L =0V	—	1	—	mA

Switching characteristics (Ta = -20 to 85°C)

Item	Symbol	Condition VCC[V] _a		Standard value			Unit
				MIN.	Standard	MAX.	
MAX. clock frequency	f _{MAX}	5	tr = tf = 20ns, CL = 50pF	1	—	—	MHZ
MIN. width of clock pulse	t _{WL}	5	tr = tf = 20ns, CL = 50pF	—	—	500	ns
	t _{WH}	5	tr = tf = 20ns, CL = 50pF	—	—	1000	ns
MIN. width of reset pulse	t _{WR}	5	tr = tf = 20ns, CL = 50pF	—	—	1000	ns
Time delay (from clock input to φ output)	t _{pd}	5	tr = tf = 20ns, CL = 50pF	—	—	2000	ns
Set time	t _{SET}	5	tr = tf = 20ns, CL = 50pF	0	—	—	ns
Holding time	t _{HOLD}	5	tr = tf = 20ns, CL = 50pF	250	—	—	ns

Measured waveforms on switching time scale

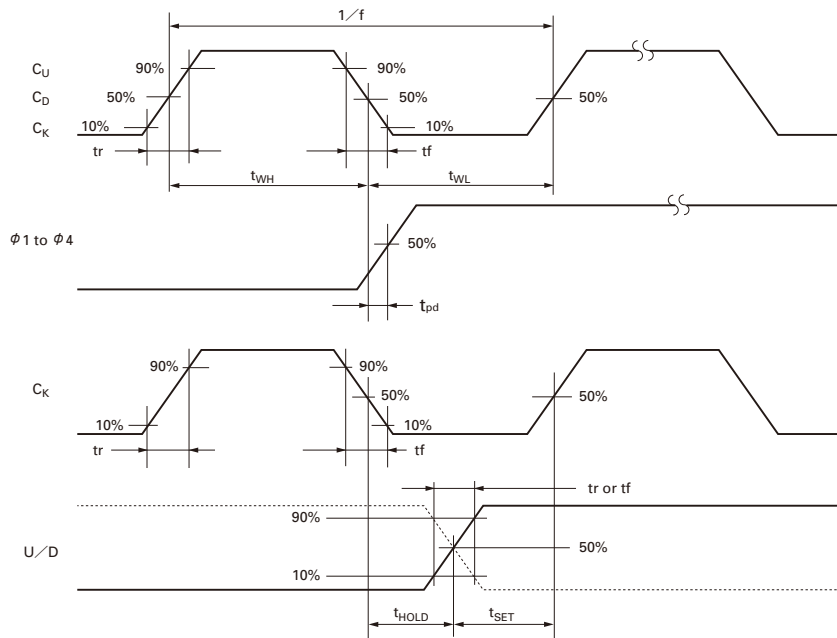

Function Table

Input modes and rotation direction

Input mode	Input				Rotation direction
	CU	CD	CK	U / D	
2 input mode (CW, CCW)	↓	L	L	L	CW
	L	↓	L	L	CCW
Pulse and direction mode (CK, U/D)	L	L	↓	H	CW
	L	L	↓	L	CCW

Energization modes

Excitation mode	Input			
	R	EA	EB	φ C
1 EX	H	H	L	H
1-2EX	H	H	H	H
2 EX	H	L	L	H

Universal controller IC for the 2-phase stepping motor drive

PMM8713PT

Energization Sequence

1EX

Pulse Face	0 (Reset)	1	2	3	4
$\phi 1$	1	0	0	0	1
$\phi 2$	0	1	0	0	0
$\phi 3$	0	0	1	0	0
$\phi 4$	0	0	0	1	0
E_M	0	0	0	0	0
UP	▶				
DOWN	◀				

2EX

Pulse Face	0 (Reset)	1	2	3	4
$\phi 1$	1	1	0	0	1
$\phi 2$	0	1	1	0	0
$\phi 3$	0	0	1	1	0
$\phi 4$	1	0	0	1	1
E_M	1	1	1	1	1
UP	▶				
DOWN	◀				

1-2EX

Pulse Face	0 (Reset)	1	2	3	4	5	6	7	8	
$\phi 1$	1	1	1	0	0	0	0	0	1	
$\phi 2$	0	0	1	1	1	0	0	0	0	
$\phi 3$	0	0	0	0	1	1	1	0	0	
$\phi 4$	1	0	0	0	0	0	1	1	1	
E_M	1	0	1	0	1	0	1	0	1	
UP	▶									
DOWN	◀									

• Reset after changing the energization mode.

Input Pulse Monitor

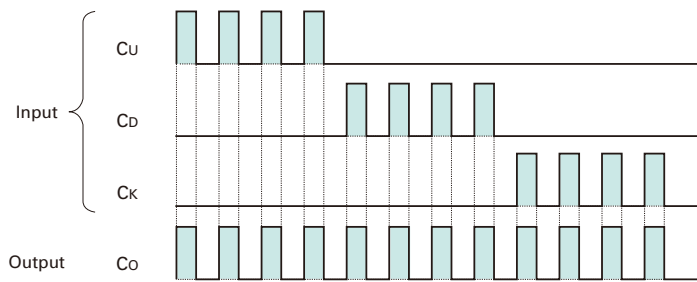

Example of Application Circuit (Bipolar wiring motor)

Combined with the power hybrid IC

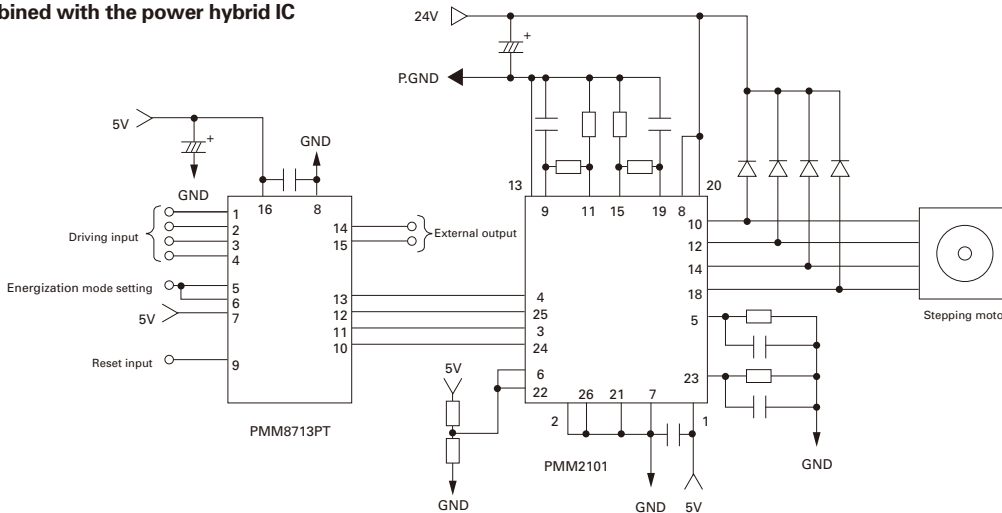

Energization mode setting

Pin No.	Terminal symbol	Input level	Motor operation
5,6	E_A, E_B	H	1-2EX
		L	2EX

- The normal initial reset may not be performed during unstable VCC after turning the power ON. For reliable resetting, hold the R terminal (9-pin) at the "L" level till the VCC becomes stable.

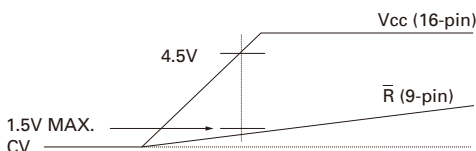

- Power hybrid IC : Refer to page 47 for the PMM2101 specifications.
- Refer to the PMM8713PT Operation Manual for other application circuit examples.

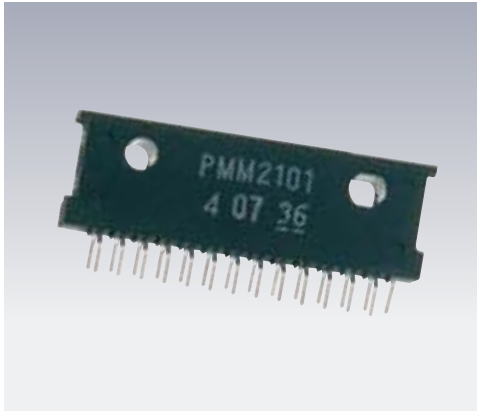

HIC for the 2-phase stepping motor

PMM2101

Full Step / Half Step

Bipolar

Characteristics

- Enables high speed and high torque operation by using bipolar constant current switching method.
- Enables compact driving circuit configuration with few of externally attached parts.
- The overheat protection circuit is incorporated to assist the safety design.

Maximum Rating (Tc=25°C)

Item	Symbol	Rated value	Unit
Source voltage-1	V _{CC1}	8 to 60	V
Source voltage-2	V _{CC2}	0 to 7	V
Output current	I _o	1.4	A
Allowable loss	P _T	35 (T _c = 25°C)	W
Thermal resistance	θ _{jc}	3.57	°C/W
	θ _{ja}	25	°C/W
Junction temperature	T _{jmax}	150	°C
Conservation temperature	T _{stg}	-40 ~ 150	°C

Recommended Operating Conditions (Tc=25°C)

Item	Symbol	Rated value	Unit
Source voltage-1	V _{CC1}	10 to 50	V
Source voltage-2	V _{CC2}	4.75 to 5.25	V
Output current	I _o	1.0	A
Oscillator frequency	F _c	20 to 27	kHz
Operation temperature	T _c	-25 to 85	°C

Dimensions [Unit : mm (inch)]

Pin No.	Name	Function
1.	V _{CC2}	Power terminal for controller section
2.	ENA A	Enable input terminal
3.	φ 1	Arm drive input
4.	φ 2	Arm drive input
5.	CR A	One shot time constant setting terminal
6.	V _{ref} A	Motor current setting terminal
7.	LG A	GND
8.	V _{CC1} A	Motor driver power terminal
9.	V _S A	Motor current detection terminal
10.	M1	Motor output
11.	R _S A	Detection resistor connecting terminal
12.	M2	Motor output
13.	PG	P.GND
14.	M3	Motor output
15.	R _S B	Detection resistor connecting terminal
16.	NC	—
17.	NC	—
18.	M4	Motor output
19.	V _S B	Motor current detection terminal
20.	V _{CC1} B	Motor driver power terminal
21.	LG B	GND
22.	V _{ref} B	Motor current setting terminal
23.	CR B	One shot time constant setting terminal
24.	φ 3	Arm drive input
25.	φ 4	Arm drive input
26.	ENA B	Enable terminal
27.	AL	Overheat alarm output terminal

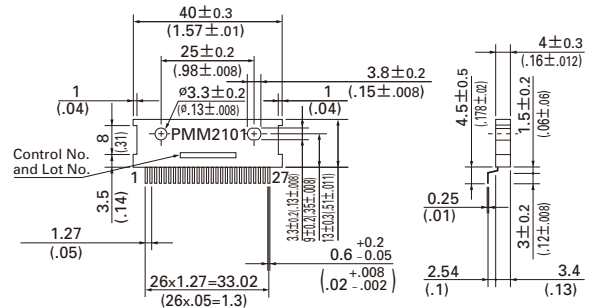

Operational truth value table

ENA A(ENA B)	φ 1(φ 3)	φ 2(φ 4)	M1(M3)	M2(M4)
L	L	L	OFF	OFF
L	L	H	L	H
L	H	L	H	L
L	H	H	OFF	OFF
H	—	—	OFF	OFF

HIC for the 2-phase stepping motor

PMM2101 Full Step / Half Step

Electrical Characteristics (Ta=25)

Item	Symbol	Condition	Rating			Unit
			MIN.	Standard	MAX.	
"H"level input voltage	V _{IH}	V _{CC2} = 5V	2.7	—	V _{CC2}	V
"L"level input voltage	V _{IL}	V _{CC2} = 5V	0	—	1.0	V
"H"level input current	I _{IH}	V _{CC2} = 5V, V _I = 5V	—	—	10	μA
"L"level input current	I _{IL}	V _{CC2} = 5V, V _I = 0V	—	—	-50	μA
Reference voltage (V _{ref}) input current	I _{ref}	V _{CC2} = 5V, V _{ref} = 0V	—	—	-10	μA
Current detection (V _s) input current	I _s	V _{CC2} = 5V, V _s = 0V	—	—	-10	μA
Forward direction voltage of FET diod	V _F	I _F = 1A	—	1.3	1.5	V
High output saturating voltage	V _{ce(sat)H}	I _C = 1A	—	1.0	1.4	V
Low output saturating voltage	V _{ce(sat)L}	I _C = 1A	—	1.0	1.3	V
Low output saturating voltage	I _s	V _{CC1} = 60V, V _{OUT} = 0V	—	—	10	μA
Low output saturating voltage	I _s	V _{OUT} = 60V, V _{RS} = 0V	—	—	10	μA
Power current to controller section	I _{CC2}	V _{CC2} = 5V (during circuit operation)	—	—	75	mA
Alarm terminal current	I _{alm}	V _{CC2} = 5V, V _{alm} = 0.5V	—	—	2	mA
Overheat alarm operating temperature	—	—	—	125	—	°C
Overheat protection stop temperature	—	—	—	150	—	°C

Overheat Alarm Output

The overheat protection circuit outputs an alarm signal at +125°C at the internal junction in the IC, and activates (motor excitation OFF) at +150°C.

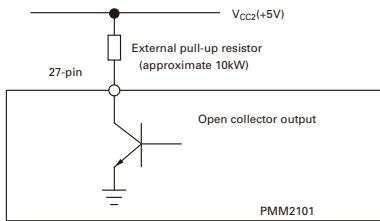

- Transistor ON during alarming
V_{ce} (ON) : 0.5V MAX.
I_{alm} : 2mA MAX.
- The alarming signal output and overheat protection circuit recover automatically when the temperature lowers.

Example of Application Circuit

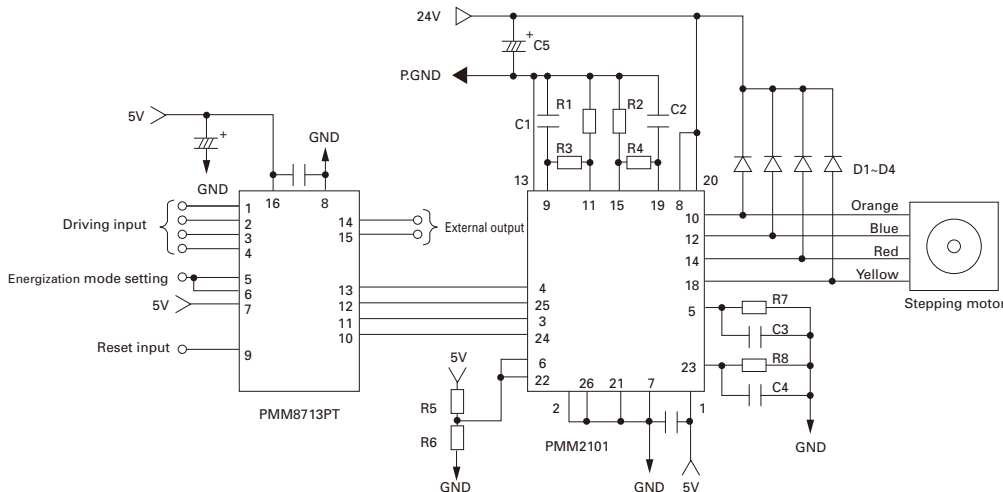

- Refer to page 53 for the PMM8713PT specifications.
- Recommended circuit constants for PMM2101

Applicable	Constant	Applicable	Constant
R1,R2	5W 0.68 Ω	C1, C2	1000pF
R3,R4	1/4W 3.9k Ω	C3, C4	3300pF
R7,R8	1/4W 15k Ω	C5	330 μF

- Determine on the R5 and R6 constants referring to the V_{ref}-output current characteristics.
- Determine on D1 to D4.
Peak reverse voltage ≥ 100V
Output current ≥ 1A
Reverse recovery time ≤ 100ns

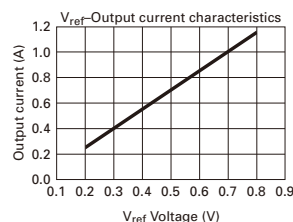



HIC for the 2-phase stepping motor

PMM2301

Micro Step

Unipolar

Characteristics

- Sine wave driven micro-step driver.
- The current detection resistor is incorporated.
- MOSFET is used for the power driving circuit to reduce heating.
- Totally packaged to reduce parts for the peripheral circuit.
- Enables selection from the 5 various excitation modes by the external bit signal.

Maximum Rating (T_C=25°C)

Item	Symbol	Condition	Rated value	Unit
Source voltage-1	V _{CC1} MAX.	V _{CC2} = 0V	52	V
Source voltage-2	V _{CC2} MAX.	With no signal	7	V
Input voltage	V _{in} MAX.	Logic input terminal	7	V
Phase current	I _{OH} MAX.	0.5sec, 1pulse, V _{CC1} applied	4	A
Operating temperature on PCB	T _C MAX.	—	105	°C
Junction temperature	T _J MAX.	—	150	°C
Conservation temperature	T _{stg}	—	-40 to 125	°C

Recommended Operating Conditions (T_a=25°C)

Item	Symbol	Condition	Rated value	Unit
Source voltage-1	V _{CC1}	With signal	10 to 45	V
Source voltage-2	V _{CC2}	With signal	5.0 ± 5%	V
Input voltage	V _{IH}	—	0 to V _{CC2}	V
Phase current	I _{OH}	Duty 50%	3	A
Clock frequency	Clock	—	DC to 50	kHz
Withstand voltage of phase driver	V _{DSS}	—	100	V

Dimensions [unit: mm (inch)]

Pin No.	Terminal name	Pin No.	Terminal name
1.	B	12.	V _{CC2}
2.	B	13.	V _{CC2}
3.	P.GND A	14.	Clock
4.	P.GND B	15.	CW / CCW
5.	A	16.	Reset
6.	A	17.	Return
7.	V _{CC2}	18.	Enable
8.	V _{ref}	19.	M ₀₁
9.	Mode 1	20.	M ₀₁
10.	Mode 2	21.	M ₀₂
11.	Mode 3	22.	GND

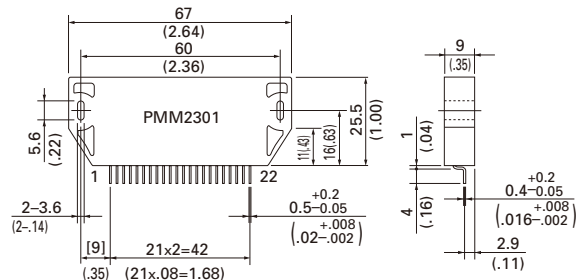

Each Terminal Function

Terminal name	Function	Functioning condition															
V _{ref}	Motor current setting input	—															
Clock	Motor driving pulse input	Mode 3 = "H" level : Operates at rising edge Mode 3 = "L" level : Operates at rising and falling edges															
CW / CCW	Motor rotation direction setting input	"H" level = CW rotation "L" level = CCW rotation															
Reset	System reset	Reset = "L"															
Return	Forced return to phase origin	Forced shift to the origin of the present energization phase with Return = "H"															
Enable	Power OFF input	Enable = "L"															
M ₀₁	Phase origin monitor output	"L" level output at the phase origin.															
M ₀₁ , M ₀₂	Monitor output on phase energization status	Outputs level signal on the present phase energization status.															
		<table border="1"> <thead> <tr> <th>Phase coordinate</th> <th>A phase</th> <th>B phase</th> <th>\bar{A} phase</th> <th>\bar{B} phase</th> </tr> </thead> <tbody> <tr> <td>M01</td> <td>H</td> <td>L</td> <td>L</td> <td>H</td> </tr> <tr> <td>M02</td> <td>L</td> <td>H</td> <td>L</td> <td>H</td> </tr> </tbody> </table>	Phase coordinate	A phase	B phase	\bar{A} phase	\bar{B} phase	M01	H	L	L	H	M02	L	H	L	H
Phase coordinate	A phase	B phase	\bar{A} phase	\bar{B} phase													
M01	H	L	L	H													
M02	L	H	L	H													

HIC for the 2-phase stepping motor

PMM2301 Micro Step

Energization Mode Table

Input condition			Energization mode	1 step angle (degree)	Number of basic angle division
Mode1	Mode2	Mode3			
L	L	H	2EX	1.8	1/1
H	L	H	1-2EX	0.9	1/2
L	H	H	W1-2EX	0.45	1/4
H	H	H	2W1-2EX	0.225	1/8
H	H	L	4W1-2EX	0.1125	1/16

● Conditioned on the Mode 3 = L, one pulse operation is performed at every rising and falling edge of the clock pulse. Accordingly, the operation becomes unstable if the driving pulse duty ratio deviates from 50%.

Electrical Characteristics (Tc=25°C, Vcc1=24V, Vcc2=5V)

Item	Symbol	Condition	Rating			Unit
			MIN.	Standard	MAX.	
V _{CC2} Power current	I _{CCO}	Enable = "L"	—	4.5	15	mA
Effective output current	I _{oave}	Each phase R/L = 3.5Ω/3.8mH, V _{ref} = 0.6V	0.45	0.50	0.55	A
Forward direction voltage of FET diode	V _{df}	I _f = 1A	—	1.2	1.8	V
Output saturating voltage	V _{sat}	RL = 7.5Ω (I ≐ 3.0A)	—	1.4	2.6	V
"H" level input voltage	V _{IH}	9 to 11, 14 to 18 pins	4.0	—	—	V
"L" level input voltage	V _{IL}	9 to 11, 14 to 18 pins	—	—	1.0	V
Input current	I _{IL}	9 to 11, 14 to 18 pins = GND level, Pull-up resistor 20kΩ	125	250	510	μA
V _{ref} input voltage	V _r	8-pin	0	—	V _{CC2} / 2	V
V _{ref} input curren	I _r	8-pin	—	1	—	μA
"H" level output voltage	V _{OH}	19 to 21 pins I = 3mA, I = -3mA	2.4	—	—	V
M ₀₁ , M _{01s} , M ₀₂						
"L" level output voltage	V _{OL}	19 to 21 pins I = 3mA, I = -3mA	—	—	0.4	V
M ₀₁ , M _{01s} , M ₀₂						
PWM frequency	F _C	—	37	47	57	kHz

Example of Application Circuit

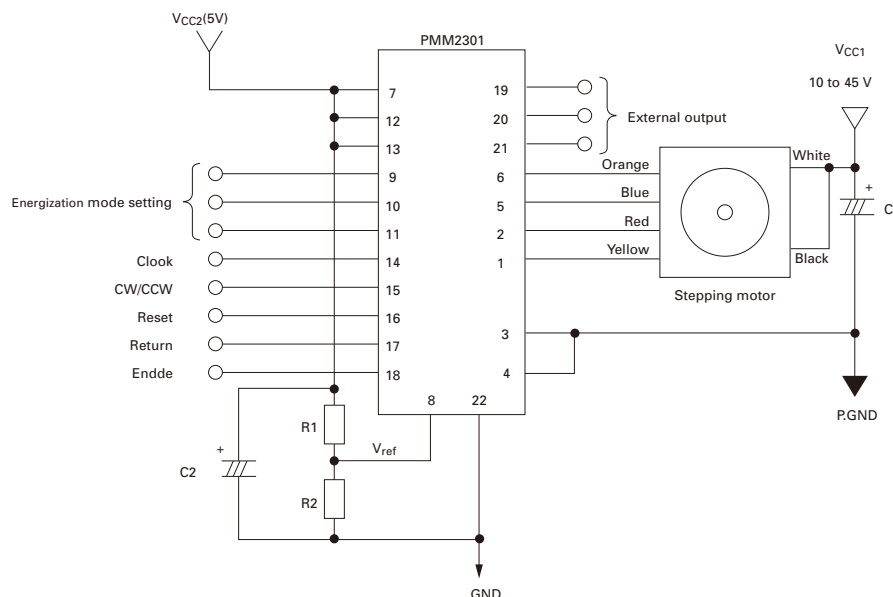

Recommended circuit constants

C1	C2
100 μF or over	10 μF

● Determine on the R1 and R2 constants based on the V_{ref} voltage calculated from the following formula.
V_{ref} (V) = Motor current adjusted value (A/phase) x 0.6

Safety Consideration

The drivers and stepping motors are the products designed to be used for the general industrial devices.

When using those, pay enough attention to the following points.

- Read thoroughly the Operation Manual prior to placement, assembly and/or operation in order to use the product properly.
- Refrain from modifying or processing the product in any way.
- Consult with the distributor or professional experts for placement or maintenance services of the product.
- In case of the following uses of the product, contact with us for the special care required to the operation, maintenance and management such as multiplexing the system, installing an emergency electric generator set, or so forth.

- 1 Use for the medical devices concerned with a fatal accident.
- 2 Use for trains, elevators, and so forth that are likely to cause an accident resulting in injury, damage or death.
- 3 Use in the computer system highly influential to the social life or the public systems.
- 4 Use in other devices highly influential to maintaining the human safety or the public functions.

In addition to the above, consult with us for use in such a vibration environment as automobile or transportation.

Read the Operation Manual thoroughly prior to the use (placement, operation, maintenance and inspection) to put the product in use properly.

Make yourself knowledgeable and familiarize with the devices, safety issues and cautions before handling the product.

After reading the Operation Manual or the like, keep it in the place where the users can refer to whenever necessary.

Indication by (Warning Label) on the product

Either or all of the following indications are given by the Warning Labels depending on the type of the driver or stepping motor.



This label is stuck near the high voltage part such as the electrically charged or cover-protected section, warning that the place where it is likely to cause an electric shock.



This label is stuck on the place where the driver or stepping motor body should be easily acknowledged, warning that it is likely to cause burns from high temperature.



This label is stuck near the GND terminals of the driver or stepping motor for which grounding is required, suggesting that the terminals should be actually grounded.



This label is stuck for the driver or stepping motor to which the power source is applied in the voltage exceeding the safety standard, drawing attention against the electric shock.

Safety ranks of the cautions

Following four ranks are provided.



DANGER Improper operations or use is most likely to result in serious injury or death.



CAUTION Improper operations or use is likely to result in average or minor injury, or in property damage.

In spite of the cautions with the $\triangle_{CAUTION}$ CAUTION label, it may cause serious results. Either the contents of the labels is describing important cautions to be followed inevitably.



PROHIBITED Indicates what shall not be done.



COMPULSORY Indicates what shall be done.

DANGER

< General matters >

1. Do not use the product in an explosive, flammable or corrosive atmosphere, watery place or near a combustible material. Doing so may cause injury or fire.
2. Have a person with expert knowledge for performing the transportation, placement, wiring, operation, maintenance or inspection of the product. Without such knowledge, it may cause an electric shock, injury or fire.
3. Do not work for wiring, maintenance servicing or inspection with the electric power on. Perform either of those five minutes after turning the power off, or otherwise, it may cause an electric shock.
4. When the protective functions of the product is activated, turn the power off immediately and eliminate the cause. If continuing the operation without eliminating the cause, the product may operate improperly and cause injury or a breakdown of the system devices.
5. Stepping motor may run out of order at the operating and stopping occasions, depending on the magnitude of the load. Put the product into use after confirming with the adequate trial test operation in the maximum load conditions that the product performs reliable operation. Doing otherwise may cause a breakdown of the system. (Should the product run out of order in the use to drive upward/downward, it may cause a fall of the load.)
6. Do not touch the internal parts of the driver. Doing so may cause an electric shock.

< Wiring >

7. Do not connect the stepping motor directly with the commercial power outlet. Doing so may cause an electric shock, injury or fire. The power shall be supplied to the stepping motor through the driving circuit.
8. Use the electric power source within the rated input voltage. Using otherwise may cause fire or an electric shock.
9. Connect the driver and stepping motor to the ground. Using without grounding may cause an electric shock.
10. Do not harm, forcibly put a stress, or load a heavy article on the cable or get it caught between the articles. Doing so may cause an electric shock.
11. Perform wiring with the power cable as instructed by the wiring diagram or the Operation Manual. Doing otherwise may cause an electric shock or fire.

< Operation >

12. Be sure not to touch the rotating part of the stepping motor during its operation. Touching it may cause injury.
13. Neither reach or touch the electric terminals while electric power is on. Doing so may cause an electric shock.
14. Never disconnect any of the connectors while electric power is on. Doing so may cause an electric shock and corruption.

< General matters >

1. Prior to placement, operation, maintenance servicing or inspection, be sure to read the Operation Manual and follow the instructions to perform those. Failure to follow the instructions may cause an electric shock, injury or fire.
2. Do not use the driver or the stepping motor outside the specified conditions. Doing so may cause an electric shock, injury or fire.
3. Do not insert a finger or a thing into the opening of the product. Doing so may cause an electric shock, injury or fire.
4. Do not use the damaged driver or stepping motor. Doing so may cause injury, fire or the like.
5. Use the driver and stepping motor in the designated combination. Using otherwise may cause fire or a trouble.
6. Be careful that the temperature rises in the operating driver, stepping motor or peripheral devices. Failure to be careful may cause a burn.

< Unpacking >

7. Unpack while confirming the ceiling. Failure to do so may cause injury.
8. Confirm if the product is the one having been ordered. Installing an incorrect product may cause a breakdown.

< Wiring >

9. Do not perform measurement of the insulation resistance or withstand insulation voltage of the product. Doing so may cause a breakdown. Instead, contact with us for such inspection.
10. Perform wiring conforming to the technical standards of electric facility or the internal rule. Doing otherwise may cause burning or fire.
11. Ensure that wiring has been correctly done. Operating without correct wiring may cause the stepping motor to run out of control and result in injury.

12. Take insulation process for the attached condenser or the external resistance connection terminals. Failure to do so may cause an electric shock.

< Placement >

13. Do not climb or attach a heavy article on the product. Doing so may cause injury.
14. Neither block nor stuff the aspiration/exhaust vent with a foreign particle. Doing so may cause fire.
15. Follow the instructions for the direction to place. Failure to do so may cause a trouble.
16. Keep a distance as instructed by the Operation Manual for the driver from the inner surface of the control console or other devices. Failure to do so may cause a trouble.
17. Place the product with a great care so as to prevent from the danger such as a tumble or a turnover.

CAUTION

18. Mount the product on an incombustible material such as metal. Doing otherwise may cause fire.

19. Confirm the rotating direction before connecting with the mechanical device. Failure to do so may cause injury or a breakdown.

20. Do not touch the motor output spindle (including the key slot and gears) with a bare hand. Doing so may cause injury.

< Operation >

21. The stepping motor is not equipped with any protective device. Take protective measures using an over-current protective relay, a ground fault interrupter, a protective device from excess temperature, and an emergency stopping device. Failure to do so may cause injury or fire.

22. Do not touch the product for a period after the power is on or has been turned off, since the driver and stepping motor remain in the high temperature. Doing so may cause burns. Especially the temperature rises considerably of the stepping motor depending on the operating conditions. Use the motor on the condition so that its surface temperature becomes 100°C or under.

23. Stop the operation immediately when an emergency occurs. Failure to do so may cause an electric shock, injury or fire.

24. Do not change adjustment to an extreme, for such a change results in the unstable operation. Doing so may cause injury.

25. When conducting the trial operation, make the stepping motor fixed firmly, and confirm the operation by disconnecting with the mechanical system before connecting with it. Failure to do so may cause injury.

26. When the alarm has been activated, eliminate the cause and ensure the safety to resume operation. Failure to do so may cause injury.

27. When the electric power recovers after the momentary interruption, do not approach the devices because the system may re-start operation by itself. (Set the system so as to secure the safety even when it re-start on such occasion.) Failure to do so may cause injury.

28. Confirm that the electric power supply is all proper conforming to the specifications. Failure to do so may cause a trouble.

29. The brake mechanism of the motor with the electro-magnetic brake is to hold the movable section and the motor position. Do not use it as a safety measure, or doing so may cause the breakdown of the system.

30. Fix the key firmly when operating the motor with key individually. Failure to do so may cause injury.

< Maintenance services >

31. Be careful when performing maintenance services or inspection about the temperature which rises highly in the driver and stepping motor frame. Failure to do so may cause burns.

32. It is recommended to replace the electrolytic condenser of the driver with a new one for securing the preventive measure after using for 5 years, the expected life in the average 40°C. The expected life of the fuse is 10 years in the average 40°C. Thus, the periodical replacement is recommended.

33. Contact with us for repair. If the product is disassembled by the user, it may put it out of action.

< Transportation >

34. Handle the product with care during transportation so as to prevent from the danger such as a tumble or a turnover.

35. Do not hold with the cable or the motor spindle. Doing so may cause a trouble or injury.

< Retirement >

36. When scrapping the driver or stepping motor, treat it for the general industrial waste.

PROHIBITED

< Storage >

1. Avoid the place exposed to rain or water drops, or in an environment with hazardous gas or liquid for storing the product. Failure to do so may cause a trouble.

< Maintenance services >

2. Do not assemble or repair the product. Doing so may cause fire or an electric shock.

< General matters >

3. Do not remove the rating plate.

COMPULSORY

< Storage >

1. Store the product within the specified conservation temperature and humidity in the place not exposed to the sun beam.

2. If the driver has been stored for a long period (3 years or longer for a guide), consult with us. The capacitance may have decreased with the electrolytic condenser due to the long period storage, and it may cause a trouble.

< Operation >

3. Install an external emergency stop circuit to turn the power off for the instant halt of operation.

4. Put the product into operation in the specified ambient temperature and humidity.

< Transportation >

5. Excess loading of the product on the carrier may cause the load to fall in pieces. Follow the instructions given outside the package.



Inquiry Check Sheet

For more information regarding any products or services described here in, please contact your nearest office listed on the back of this catalog.

To SANYO DENKI Co.,LTD.

Date : _____

Company: _____

Department: _____

Name: _____

Tel: _____

FAX: _____

E-mail: _____

Item	Contents																																																																																																
①	Name of target equipment Equipment name, category (transport, processing, test, other)																																																																																																
②	Name of servo axis Axis name, axial mechanism (horizontal/vertical), brake mechanism (yes/no)																																																																																																
③	Current condition of above axis Manufacturer Name () Series Name () Motor Capacity () Hydraulic, Mechanical, or New System ()																																																																																																
④	Positioning accuracy \pm mm \pm μ m																																																																																																
⑤	Operation pattern <div style="display: flex; justify-content: space-between; align-items: flex-start;"> <div style="text-align: center;"> <p>Feeding Speed [m/sec]</p> <p>Time [sec]</p> </div> <div style="font-size: small;"> <p>[Reference formula] $1G=9.8[m/s^2], 1[m/s^2] \div 0.1G$ $[\alpha[m/s^2]]=V[m/sec] \div t1[sec]$ $[D[m]]=V[m/sec] \times (t1+t2)[sec]$</p> </div> </div>																																																																																																
⑥	Mechanism Ball-screw/screw-rotation type (horizontal), ball-screw/nut-rotation type (horizontal), rack and pinion (horizontal), belt/chain (horizontal), rotary table, roll feed, instability																																																																																																
⑦	Mechanical structure <table style="width: 100%; font-size: x-small; border-collapse: collapse;"> <tr> <td>WT (table mass)</td><td>kg</td><td>WL (work mass)</td><td>kg</td><td>WA (mass of other drive parts)</td><td>kg</td> </tr> <tr> <td>WR (rack mass)</td><td>kg</td><td>WB (belt/chain mass)</td><td>kg</td><td>WC (counterbalance mass)</td><td>kg</td> </tr> <tr> <td>Fa (external force axial direction)</td><td>N</td><td>Fb (ball-screw preload)</td><td>N</td><td>T (roll pushing force)</td><td>N</td> </tr> <tr> <td>Dr1 (drive-side roll diameter)</td><td>mm</td><td>Dr2 (follower-side roll diameter)</td><td>mm</td><td></td><td></td> </tr> <tr> <td>Lr1 (drive-side roll length)</td><td>mm</td><td>Lr2 (follower-side roll length)</td><td>mm</td><td>G (reduction ratio)</td><td></td> </tr> <tr> <td>JG (speed-reducer inertia)</td><td>kg·m²</td><td>JC (coupling inertia)</td><td>kg·m²</td><td></td><td></td> </tr> <tr> <td>JN (nut inertia)</td><td>kg·m²</td><td>JO (other motor-axis conversion inertia)</td><td>kg·m²</td><td></td><td></td> </tr> <tr> <td>Db (ball-screw diameter)</td><td>mm</td><td>Lb (ball-screw axial length)</td><td>mm</td><td>Pb (ball-screw lead)</td><td>mm</td> </tr> <tr> <td>Dp (pinion/pulley diameter)</td><td>mm</td><td>Lp (pinion axial length)</td><td>mm</td><td>tp (pulley thickness)</td><td>mm</td> </tr> <tr> <td>Dt (table diameter)</td><td>mm</td><td>Dh (table-support diameter)</td><td>mm</td><td>LW (load shift from axis)</td><td>mm</td> </tr> <tr> <td>Ds (table shaft diameter)</td><td>mm</td><td>Ls (table shaft length)</td><td>mm</td><td></td><td></td> </tr> <tr> <td>ρ (specific gravity of ball-screw/pinion/pulley/table-shaft material)</td><td></td><td></td><td>kg·cm³</td><td></td><td></td> </tr> <tr> <td>μ (friction coefficient between sheet and shilding-surface/support-section/roll)</td><td></td><td>$\rho 1$ (specific gravity of roll-1 material)</td><td>kg/cm³</td><td></td><td></td> </tr> <tr> <td>$\rho 2$ (specific gravity of roll-2 material)</td><td>kg/cm³</td><td>κ (internal friction coefficient of preload nut)</td><td></td><td></td><td></td> </tr> <tr> <td>η (mechanical efficiency)</td><td></td><td>JL (load inertia of motor-axis conversion)</td><td>kg·m²</td><td></td><td></td> </tr> <tr> <td>TF (friction torque of motor axis conversion)</td><td>N·m</td><td>Tu (imbalance torque of motor axis conversion)</td><td>N·m</td><td></td><td></td> </tr> </table>	WT (table mass)	kg	WL (work mass)	kg	WA (mass of other drive parts)	kg	WR (rack mass)	kg	WB (belt/chain mass)	kg	WC (counterbalance mass)	kg	Fa (external force axial direction)	N	Fb (ball-screw preload)	N	T (roll pushing force)	N	Dr1 (drive-side roll diameter)	mm	Dr2 (follower-side roll diameter)	mm			Lr1 (drive-side roll length)	mm	Lr2 (follower-side roll length)	mm	G (reduction ratio)		JG (speed-reducer inertia)	kg·m ²	JC (coupling inertia)	kg·m ²			JN (nut inertia)	kg·m ²	JO (other motor-axis conversion inertia)	kg·m ²			Db (ball-screw diameter)	mm	Lb (ball-screw axial length)	mm	Pb (ball-screw lead)	mm	Dp (pinion/pulley diameter)	mm	Lp (pinion axial length)	mm	tp (pulley thickness)	mm	Dt (table diameter)	mm	Dh (table-support diameter)	mm	LW (load shift from axis)	mm	Ds (table shaft diameter)	mm	Ls (table shaft length)	mm			ρ (specific gravity of ball-screw/pinion/pulley/table-shaft material)			kg·cm ³			μ (friction coefficient between sheet and shilding-surface/support-section/roll)		$\rho 1$ (specific gravity of roll-1 material)	kg/cm ³			$\rho 2$ (specific gravity of roll-2 material)	kg/cm ³	κ (internal friction coefficient of preload nut)				η (mechanical efficiency)		JL (load inertia of motor-axis conversion)	kg·m ²			TF (friction torque of motor axis conversion)	N·m	Tu (imbalance torque of motor axis conversion)	N·m		
WT (table mass)	kg	WL (work mass)	kg	WA (mass of other drive parts)	kg																																																																																												
WR (rack mass)	kg	WB (belt/chain mass)	kg	WC (counterbalance mass)	kg																																																																																												
Fa (external force axial direction)	N	Fb (ball-screw preload)	N	T (roll pushing force)	N																																																																																												
Dr1 (drive-side roll diameter)	mm	Dr2 (follower-side roll diameter)	mm																																																																																														
Lr1 (drive-side roll length)	mm	Lr2 (follower-side roll length)	mm	G (reduction ratio)																																																																																													
JG (speed-reducer inertia)	kg·m ²	JC (coupling inertia)	kg·m ²																																																																																														
JN (nut inertia)	kg·m ²	JO (other motor-axis conversion inertia)	kg·m ²																																																																																														
Db (ball-screw diameter)	mm	Lb (ball-screw axial length)	mm	Pb (ball-screw lead)	mm																																																																																												
Dp (pinion/pulley diameter)	mm	Lp (pinion axial length)	mm	tp (pulley thickness)	mm																																																																																												
Dt (table diameter)	mm	Dh (table-support diameter)	mm	LW (load shift from axis)	mm																																																																																												
Ds (table shaft diameter)	mm	Ls (table shaft length)	mm																																																																																														
ρ (specific gravity of ball-screw/pinion/pulley/table-shaft material)			kg·cm ³																																																																																														
μ (friction coefficient between sheet and shilding-surface/support-section/roll)		$\rho 1$ (specific gravity of roll-1 material)	kg/cm ³																																																																																														
$\rho 2$ (specific gravity of roll-2 material)	kg/cm ³	κ (internal friction coefficient of preload nut)																																																																																															
η (mechanical efficiency)		JL (load inertia of motor-axis conversion)	kg·m ²																																																																																														
TF (friction torque of motor axis conversion)	N·m	Tu (imbalance torque of motor axis conversion)	N·m																																																																																														
⑧	Speed reducer Customer-provided (/)-Sanyo denki standard(planet/spur/no-backlash-planet /) other(/)																																																																																																
⑨	Encoder type Encoder type specified (yes / no) Yes:(incremental , optical absolute , optical absolute with incremental function, resolver absolute) Resolution()																																																																																																
⑩	Input format Position , velocity , torque , other ()																																																																																																
⑪	Host equipment (controller) Sequencer , laptop , customer-developed product , Sanyo dennki-provided , other ()																																																																																																
⑫	Usage environment and other requirements Cutting , clean-room use , anti-dust measures , other ()																																																																																																
⑬	Estimated production Single product: () units/month () units/year																																																																																																
⑭	Development schedule Prototype period: ()Year () Month Production period: ()Year () Month																																																																																																
⑮	Various measures Related documentation (already submitted; send later by mail) Visit/PR desired (yes / no) Meeting desired (yes / no)																																																																																																
⑯	Miscellaneous (questions, pending problems, unresolved issues, etc.)																																																																																																

■ Precautions For Adoption



Failure to follow the precautions on the right may cause moderate injury and property damage, or in some circumstances, could lead to a serious accident. Always follow all listed precautions.

Cautions

- Read the accompanying Instruction Manual carefully prior to using the product.
- If applying to medical devices and other equipment affecting people's lives, please contact us beforehand and take appropriate safety measures.
- If applying to equipment that can have significant effects on society and the general public, please contact us beforehand.
- Do not use this product in an environment where vibration is present, such as in a moving vehicle or shipping vessel.
- Do not perform any retrofitting, re-engineering, or modification to this equipment.
- The drivers and motors presented in this catalog are meant to be used for general industrial applications. If using for special applications related to aviation and space, nuclear power, electric power, submarine repeaters, etc., please contact us beforehand.

* For any question or inquiry regarding the above, contact our Sales Department.

SANYO DENKI CO., LTD.

1-15-1, Kita-Otsuka, Toshima-ku, Tokyo 170-8451, Japan

SANYO DENKI AMERICA, INC.

468 Amapola Avenue Torrance, CA 90501 U.S.A.

SANYO DENKI EUROPE SA.

P.A. Paris Nord II 48 Allée des Erables-VILLEPINTE BP.57286 F-95958 ROISSY CDG Cedex France

SANYO DENKI GERMANY GmbH

Frankfurter Strasse 63-69 65760 Eschborn Germany

SANYO DENKI KOREA CO., LTD.

9F 5-2, Sunwha-dong Jung-gu Seoul, 100-130, Korea

SANYO DENKI SHANGHAI CO., LTD.

Room 2116, Bldg B, FAR EAST INTERNATIONAL PLAZA, No.317 XianXia Rd., Shanghai 200051 China

SANYO DENKI TAIWAN CO., LTD.

Room 1208, 12F, No.96 Chung Shan N, Rd., Sec.2, Taipei 104, Taiwan, R.O.C.

SANYO DENKI (H.K.) CO., LIMITED

Room 2305, 23/F, South Tower, Concordia Plaza, 1 Science Museum Rd., TST East, Kowloon, Hong Kong

SANYO DENKI SINGAPORE PTE. LTD.

10 Hoe Chiang Road #14-03A/04 Keppel Towers Singapore 089315

<http://www.sanyodenki.co.jp>

Phone: +81 3 3917 5157

Phone: +1 310 783 5400

Phone: +33 1 48 63 26 61

Phone: +49 6196 76113 0

Phone: +82 2 773 5623

Phone: +86 21 6235 1107

Phone: +886 2 2511 3938

Phone: +852 2312 6250

Phone: +65 6223 1071