

Voltage Detector

KK75Axx

FUNCTIONS

- Detecting against error operations at the power ON/OFF
- Resetting function for low voltage microprocessor
- Checking low battery
- Active Low
- CMOS or open drain output (mask option)
- Tolerance $\pm 2\%$

FEATURES

- Low Power Consumption
- Low Temperature Coefficient
- Built-in Voltage Reference
- Comparator Hysteresis
- TO-92, SOT-23 packages are available

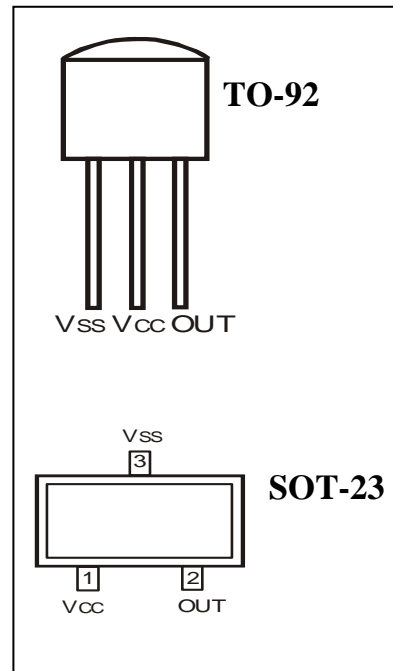

GENERAL DESCRIPTION

The KK75Axx series are the voltage detectors, consist of a high-precision voltage reference, a comparator with precise thresholds and built-in hysteresis and an output driver.

ABSOLUTE MAXIMUM RATINGS (T_A = 25°C)

Characteristic	Symbol	Value	Unit
Supply Voltage	V _{CC}	-0.3 ~ +8.0	V
Operating Temperature	T _{opr}	-10 ~ +70	°C
Storage Temperature	T _{stg}	-40 ~ +125	°C
Output Current	I _O	30	mA

ELECTRICAL CHARACTERISTICS (T_A = 25°C, unless otherwise specified)

Characteristic	Symbol	Test Conditions	Min	Typ	Max	Unit
Supply Voltage	V _{CC}		1.2		5.5	V
Detecting Voltage	V _{DET}		2.16	2.20	2.24	V
			2.35	2.40	2.45	
			2.50	2.55	2.60	
			2.65	2.70	2.75	
			2.74	2.80	2.86	
			3.23	3.30	3.37	
			3.82	3.90	3.98	
			4.12	4.20	4.28	
			4.61	4.70	4.79	
4.90	5.00	5.10				
Supply Current	I _{CC}	V _{CC} = 5.0V, No Load		8	15	μA
Low Output Voltage	V _{OL}	V _{CC} = V _{DET} - 0.2V, I _{OL} = 0.1mA		0.1	0.3	V
High Output Voltage	V _{OH}	V _{CC} = V _{DET} + 0.2V, I _{OH} = 0.1mA	V _{CC} - 0.3V			V
Hysteresis Voltage	V _{HYS}			2.0		%
Detective Voltage Temperature Coefficient	$\frac{\Delta V_{DET}}{\Delta T \times V_{DET}}$	-10°C < T _A < 70°C		± 0.02		%/°C

BLOCK DIAGRAM

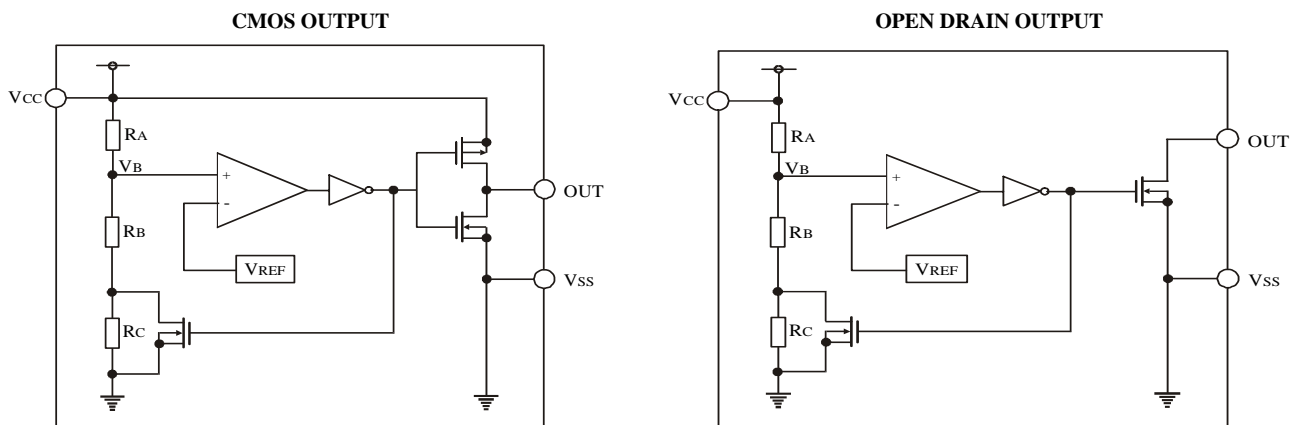

FUNCTIONAL DESCRIPTION

The KK75Axx series is the set of voltage detectors equipped with a high stability voltage reference which is connected to the negative input of a comparator - denoted as V_{REF} in block diagram.

When the voltage drop to the positive input of the comparator (V_B) is high than V_{REF}, V_{OUT} goes high.

If V_{CC} is decreased so that V_B falls to a value less than V_{REF}, the comparator output inverts from high to low, V_{OUT} goes low.

The device has hysteresis to prevent the circuit from oscillation when V_B ≈ V_{REF}.

If V_{CC} falls below the minimum operating voltage, the output becomes undefined.

The detectable voltage is defined as:

$$V_{DET}(-) = \frac{RA+RB+RC}{RB+RC} \times V_{REF}$$

The release voltage is defined as:

$$V_{DET}(+) = \frac{RA+RB}{RB} \times V_{REF}$$

The hysteresis width is:

$$V_{HYS} = V_{DET}(+) - V_{DET}(-)$$

ELECTRICAL CHARACTERISTICS

1. OUTPUT VOLTAGE vs. SUPPLY VOLTAGE
BT75A25

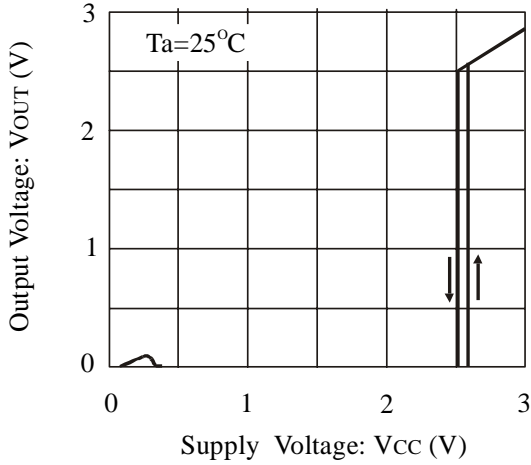

2. OUTPUT LOW CURRENT vs. SUPPLY VOLTAGE
BT75A25

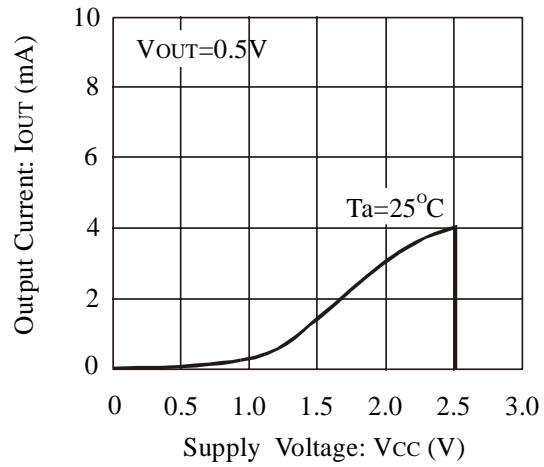

3. NORMALIZED V_{OL} vs. TEMPERATURE

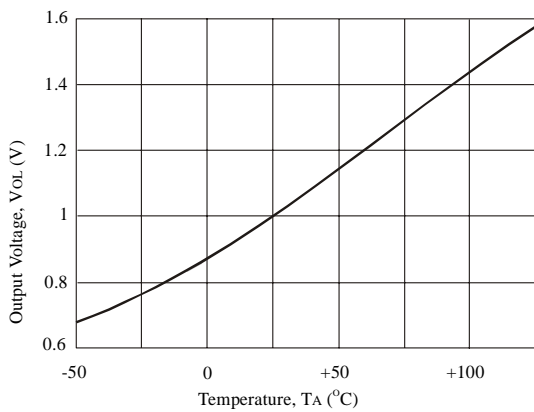

NORMALIZED V_{OH} vs. TEMPERATURE

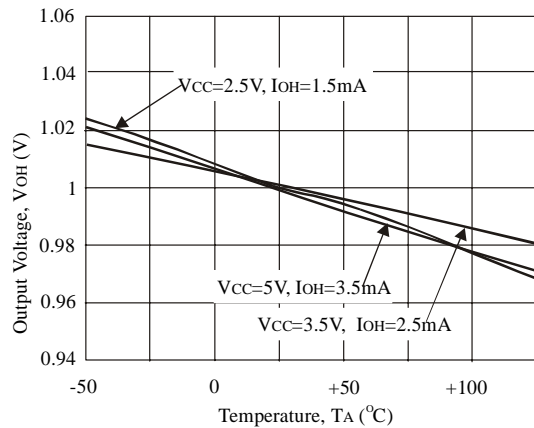

4. V_{OL} vs. OUTPUT CURRENT

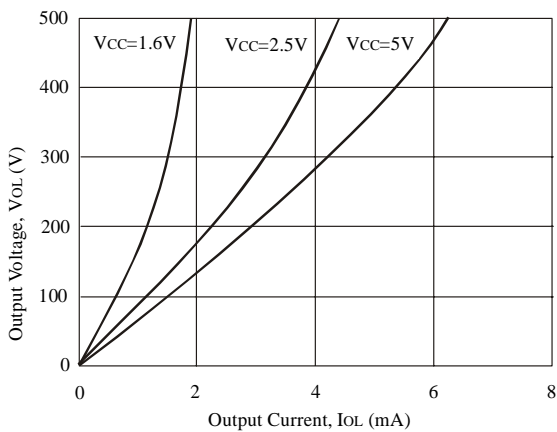

$V_{CC} - V_{OH}$ vs. OUTPUT CURRENT

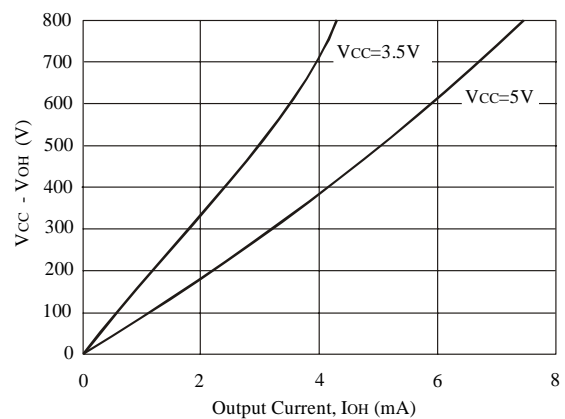

5. V_{OL} vs. SUPPLY VOLTAGE

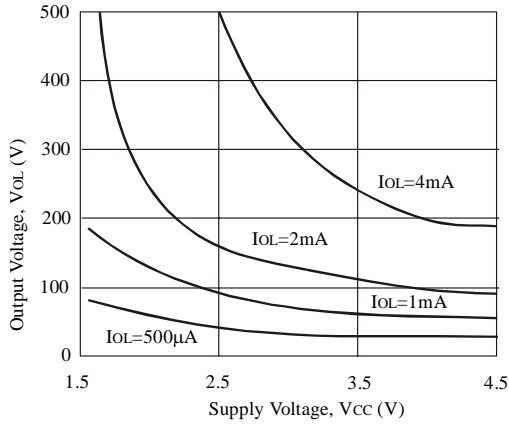

$V_{CC} - V_{OH}$ vs. SUPPLY VOLTAGE

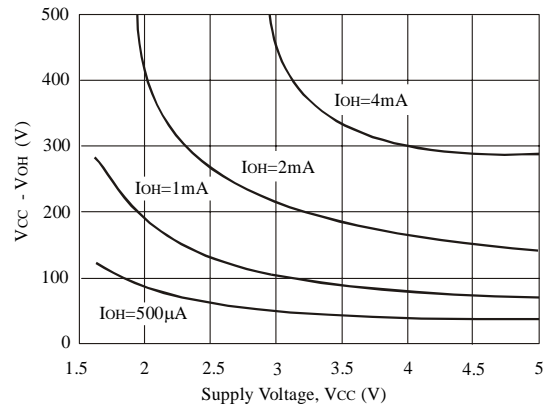

6. SUPPLY CURRENT vs. TEMPERATURE

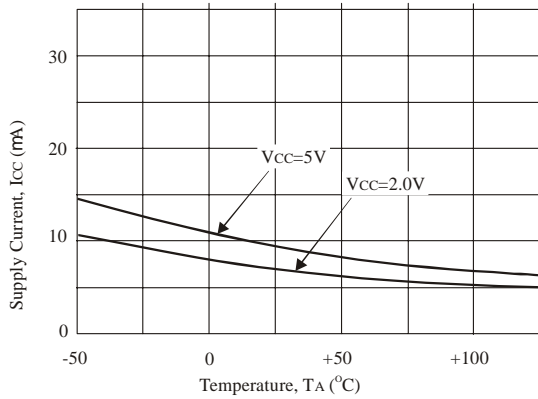

NORMALIZED THRESHOLD vs. TEMPERATURE

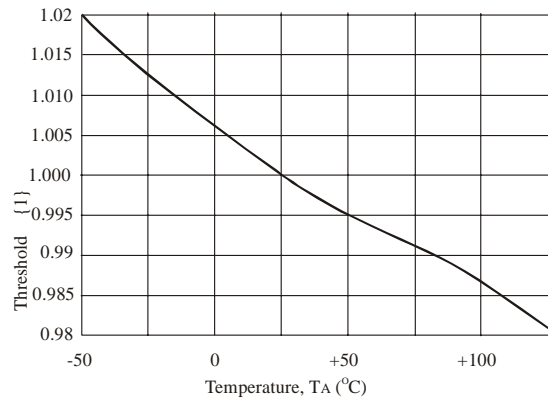

ORDERING INFORMATION

BT75A XX XX - XX

22 -> 2.20V
 24 -> 2.40V
 25 -> 2.55V
 .
 .
 42 -> 4.20V
 47 -> 4.70V
 50 -> 5.00V

PF = Pb Free

S = SOT-23
 LS = TO-92 Straight (Bulk)
 LF = TO-92 Form (Taping)

PACKAGE DIMENSIONS

SOT-23

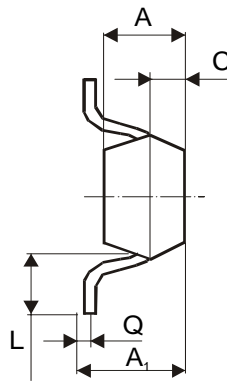
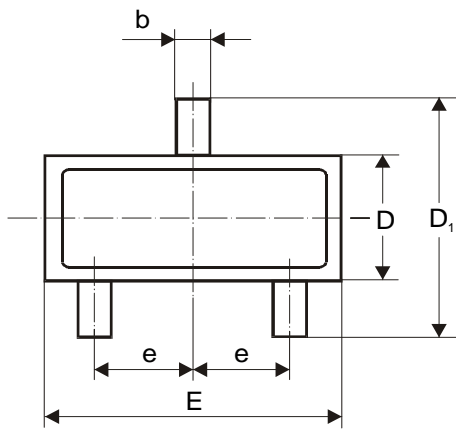

Dimension	mm	
	min	max
A	0.75	0.95
A₁	0.25	1.10
b	0.38	0.46
C	0.50	0.65
D	1.20	1.40
D₁	2.10	2.50
E	2.80	3.00
e	0.85	1.05
L	0.40	0.60
Q	0.09	0.15

TO-92

