

Description

The GM66150 series of positive fixed and adjustable regulators is designed to provide up to 1.5A output with high current, high accuracy, and extremely low dropout voltage performance. These regulators feature 300 to 350mV (full load) dropout voltages, and very low ground current. Although designed for high current loads, these devices are also useful in lower current, extremely low dropout critical systems, where the minimal dropout voltage and ground current values are important characteristics.

The GM66150 is fully protected against over current, reversed input polarity (or reversed battery connection), reversed lead insertion, over temperature operation, and transient voltage spikes (positive or negative).

Five lead fixed voltage versions feature logic level ON/OFF control and an error flag which signals whenever the output falls out of regulation.

For GM66151 and GM66152, the ENABLE pin may be tied to V_{IN} if it is not required for ON/OFF control. The GM66150 series is available in 3-pin and 5-pin TO-220 and surface mount SOT-223 and TO-263 packages.

Features

- ◆ Ultra Low Dropout Voltage of 350mV @ 1.5A with Low Ground Current
- ◆ Fixed and Adjustable Voltage Versions
- ◆ Output Current up to 1.5A
- ◆ Guaranteed 1% Accurate Tolerance
- ◆ Extremely Fast Transient Response
- ◆ Reverse-battery Protection
- ◆ "Load Dump" Protection
- ◆ Zero-Current shutdown mode(5-pin versions) Error flag signals output out-of-regulation (5-pin versions)

Application

- High Efficiency Linear Regulators
- Post Regulators for Switching Supplies
- High Efficiency "Green" Computer Systems
- Battery Powered Equipment
- Automotive Electronics

Typical Application Circuits

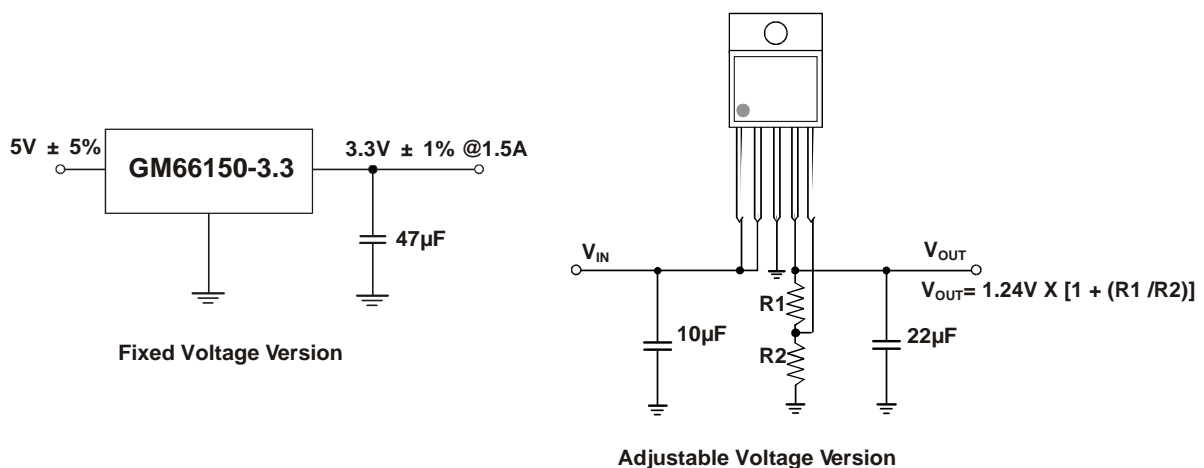

Marking Information and Pin Configurations (Top View)

GM66150 (Pb Free)

TO 220

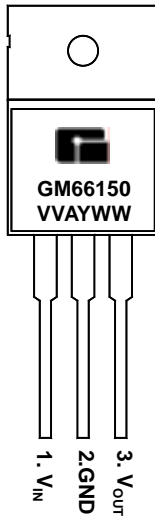

TO 263
(D²-PAK)

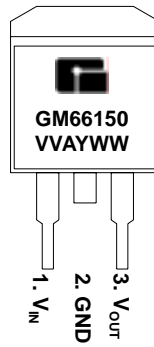

SOT223

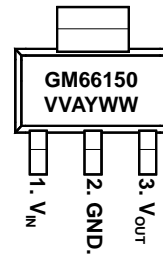

GM66150 (Green Product)

TO 220

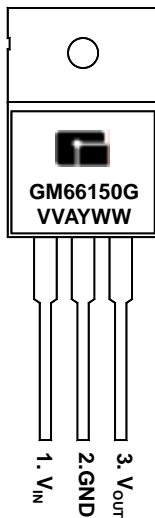

TO 263
(D²-PAK)

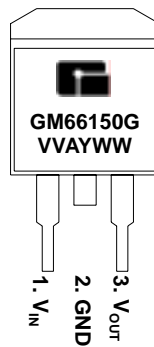

SOT223

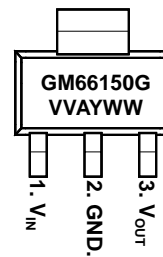

G: Green Product
 VV: Voltage suffix (15 = 1.5V, 50 = 5.0V...A = Adj)
 A: Assembly / Test site code
 Y: Year
 WW: Week

Marking Information and Pin Configurations (Top View)

GM66151 (Pb Free)

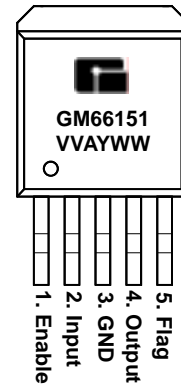
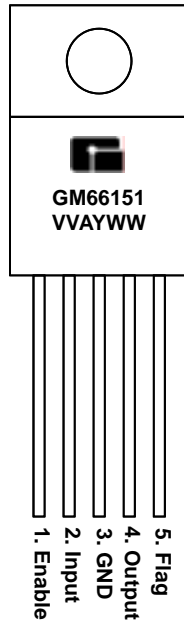

GM66151 (Green Product)

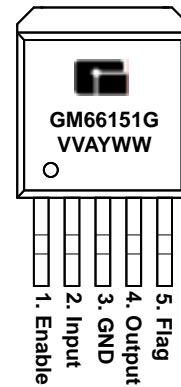
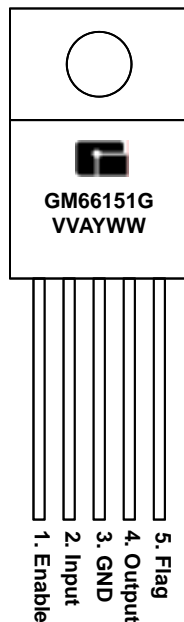

G: Green Product
 VV: Voltage suffix (15 = 1.5V, 50 = 5.0V...A = Adj)
 A: Assembly / Test site code
 Y: Year
 WW: Week

Marking Information and Pin Configurations (Top View)

GM66152 (Pb Free)

TO-220-5

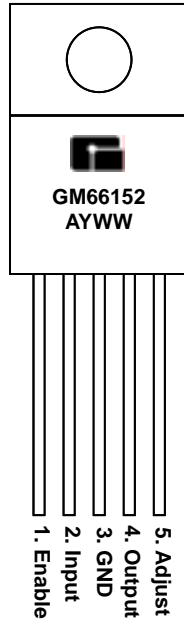

TO-263-5

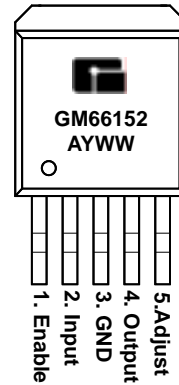

GM66152 (Green Product)

TO-220-5

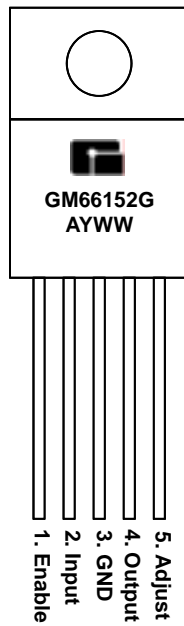

TO-263-5

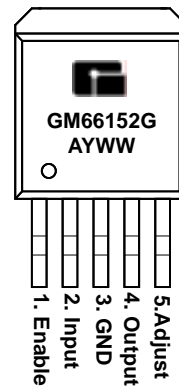

G: Green Product
 A: Assembly / Test site code
 Y: Year
 WW: Week

Marking Information and Pin Configurations (Top View)

GM66153 (Pb Free)

TO-220-5

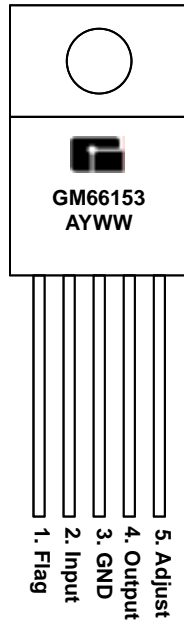

TO-263-5

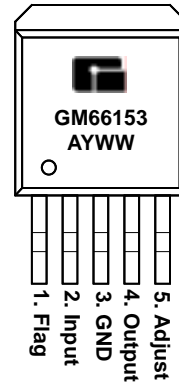

GM66153 (Green Product)

TO-220-5

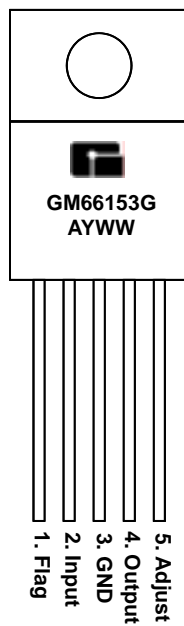

TO-263-5

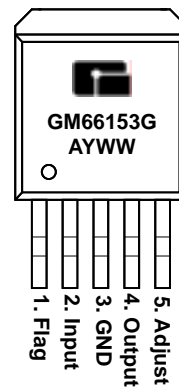

G: Green Product
 A: Assembly / Test site code
 Y: Year
 WW: Week

Ordering Information – Pb Free

Ordering Number	Output Voltage	Package	Shipping
GM66150			
GM66150-1.5TA3T	1.5V	TO-263	50 Units/Tube
GM66150-1.5TA3R	1.5V	TO-263	800 Units / Reel
GM66150-1.5TB3T	1.5V	TO-220	50 Units/Tube
GM66150-1.5ST3T	1.5V	SOT-223	80 Units/Tube
GM66150-1.5ST3R	1.5V	SOT-223	2,500 Units / Tape & Reel
GM66150-1.8TA3T	1.8V	TO-263	50 Units/Tube
GM66150-1.8TA3R	1.8V	TO-263	800 Units / Reel
GM66150-1.8TB3T	1.8V	TO-220	50 Units/Tube
GM66150-1.8ST3T	1.8V	SOT-223	80 Units/Tube
GM66150-1.8ST3R	1.8V	SOT-223	2,500 Units / Tape & Reel
GM66150-2.5TA3T	2.5V	TO-263	50 Units/Tube
GM66150-2.5TA3R	2.5V	TO-263	800 Units / Reel
GM66150-2.5TB3T	2.5V	TO-220	50 Units/Tube
GM66150-2.5ST3T	2.5V	SOT-223	80 Units/Tube
GM66150-2.5ST3R	2.5V	SOT-223	2,500 Units / Tape & Reel
GM66150-3.0TA3T	3.0V	TO-263	50 Units/Tube
GM66150-3.0TA3R	3.0V	TO-263	800 Units / Reel
GM66150-3.0TB3T	3.0V	TO-220	50 Units/Tube
GM66150-3.0ST3T	3.0V	SOT-223	80 Units/Tube
GM66150-3.0ST3R	3.0V	SOT-223	2,500 Units / Tape & Reel
GM66150-3.3TA3T	3.3V	TO-263	50 Units/Tube
GM66150-3.3TA3R	3.3V	TO-263	800 Units / Reel
GM66150-3.3TB3T	3.3V	TO-220	50 Units/Tube
GM66150-3.3ST3T	3.3V	SOT-223	80 Units/Tube
GM66150-3.3ST3R	3.3V	SOT-223	2,500 Units / Tape & Reel
GM66150-5.0TA3T	5.0V	TO-263	50 Units/Tube
GM66150-5.0TA3R	5.0V	TO-263	800 Units / Reel
GM66150-5.0TB3T	5.0V	TO-220	50 Units/Tube
GM66150-5.0ST3T	5.0V	SOT-223	80 Units/Tube
GM66150-5.0ST3R	5.0V	SOT-223	2,500 Units / Tape & Reel
GM66150-12TA3T	12V	TO-263	50 Units/Tube
GM66150-12TA3R	12V	TO-263	800 Units / Reel
GM66150-12TB3T	12V	TO-220	50 Units/Tube

Ordering Information – Green Product

Ordering Number	Output Voltage	Package	Shipping
GM66150			
GM66150-1.5TA3TG	1.5V	TO-263	50 Units/Tube
GM66150-1.5TA3RG	1.5V	TO-263	800 Units / Reel
GM66150-1.5TB3TG	1.5V	TO-220	50 Units/Tube
GM66150-1.5ST3TG	1.5V	SOT-223	80 Units/Tube
GM66150-1.5ST3RG	1.5V	SOT-223	2,500 Units / Tape & Reel
GM66150-1.8TA3TG	1.8V	TO-263	50 Units/Tube
GM66150-1.8TA3RG	1.8V	TO-263	800 Units / Reel
GM66150-1.8TB3TG	1.8V	TO-220	50 Units/Tube
GM66150-1.8ST3TG	1.8V	SOT-223	80 Units/Tube
GM66150-1.8ST3RG	1.8V	SOT-223	2,500 Units / Tape & Reel
GM66150-2.5TA3TG	2.5V	TO-263	50 Units/Tube
GM66150-2.5TA3RG	2.5V	TO-263	800 Units / Reel
GM66150-2.5TB3TG	2.5V	TO-220	50 Units/Tube
GM66150-2.5ST3TG	2.5V	SOT-223	80 Units/Tube
GM66150-2.5ST3RG	2.5V	SOT-223	2,500 Units / Tape & Reel
GM66150-3.0TA3TG	3.0V	TO-263	50 Units/Tube
GM66150-3.0TA3RG	3.0V	TO-263	800 Units / Reel
GM66150-3.0TB3TG	3.0V	TO-220	50 Units/Tube
GM66150-3.0ST3TG	3.0V	SOT-223	80 Units/Tube
GM66150-3.0ST3RG	3.0V	SOT-223	2,500 Units / Tape & Reel
GM66150-3.3TA3TG	3.3V	TO-263	50 Units/Tube
GM66150-3.3TA3RG	3.3V	TO-263	800 Units / Reel
GM66150-3.3TB3TG	3.3V	TO-220	50 Units/Tube
GM66150-3.3ST3TG	3.3V	SOT-223	80 Units/Tube
GM66150-3.3ST3RG	3.3V	SOT-223	2,500 Units / Tape & Reel
GM66150-5.0TA3TG	5.0V	TO-263	50 Units/Tube
GM66150-5.0TA3RG	5.0V	TO-263	800 Units / Reel
GM66150-5.0TB3TG	5.0V	TO-220	50 Units/Tube
GM66150-5.0ST3TG	5.0V	SOT-223	80 Units/Tube
GM66150-5.0ST3RG	5.0V	SOT-223	2,500 Units / Tape & Reel
GM66150-12TA3TG	12V	TO-263	50 Units/Tube
GM66150-12TA3RG	12V	TO-263	800 Units / Reel
GM66150-12TB3TG	12V	TO-220	50 Units/Tube

Ordering Information – Pb Free

Ordering Number	Output Voltage	Package	Shipping
GM66151			
GM66151-1.5TA5T	1.5V	TO-263-5	50 Units/Tube
GM66151-1.5TA5R	1.5V	TO-263-5	800 Units / Reel
GM66151-1.5TB5T	1.5V	TO-220-5	50 Units/Tube
GM66151-1.8TA5T	1.8V	TO-263-5	50 Units/Tube
GM66151-1.8TA5R	1.8V	TO-263-5	800 Units / Reel
GM66151-1.8TB5T	1.8V	TO-220-5	50 Units/Tube
GM66151-2.5TA5T	2.5V	TO-263-5	50 Units/Tube
GM66151-2.5TA5R	2.5V	TO-263-5	800 Units / Reel
GM66151-2.5TB5T	2.5V	TO-220-5	50 Units/Tube
GM66151-3.0TA5T	3.0V	TO-263-5	50 Units/Tube
GM66151-3.0TA5R	3.0V	TO-263-5	800 Units / Reel
GM66151-3.0TB5T	3.0V	TO-220-5	50 Units/Tube
GM66151-3.3TA5T	3.3V	TO-263-5	50 Units/Tube
GM66151-3.3TA5R	3.3V	TO-263-5	800 Units / Reel
GM66151-3.3TB5T	3.3V	TO-220-5	50 Units/Tube
GM66151-5.0TA5T	5.0V	TO-263-5	50 Units/Tube
GM66151-5.0TA5R	5.0V	TO-263-5	800 Units / Reel
GM66151-5.0TB5T	5.0V	TO-220-5	50 Units/Tube
GM66151-12TA5T	12V	TO-263-5	50 Units/Tube
GM66151-12TA5R	12V	TO-263-5	800 Units / Reel
GM66151-12TB5T	12V	TO-220-5	50 Units/Tube

Ordering Information – Green Product

Ordering Number	Output Voltage	Package	Shipping
GM66151			
GM66151-1.5TA5TG	1.5V	TO-263-5	50 Units/Tube
GM66151-1.5TA5RG	1.5V	TO-263-5	800 Units / Reel
GM66151-1.5TB5TG	1.5V	TO-220-5	50 Units/Tube
GM66151-1.8TA5TG	1.8V	TO-263-5	50 Units/Tube
GM66151-1.8TA5RG	1.8V	TO-263-5	800 Units / Reel
GM66151-1.8TB5TG	1.8V	TO-220-5	50 Units/Tube
GM66151-2.5TA5TG	2.5V	TO-263-5	50 Units/Tube
GM66151-2.5TA5RG	2.5V	TO-263-5	800 Units / Reel
GM66151-2.5TB5TG	2.5V	TO-220-5	50 Units/Tube
GM66151-3.0TA5TG	3.0V	TO-263-5	50 Units/Tube
GM66151-3.0TA5RG	3.0V	TO-263-5	800 Units / Reel
GM66151-3.0TB5TG	3.0V	TO-220-5	50 Units/Tube
GM66151-3.3TA5TG	3.3V	TO-263-5	50 Units/Tube
GM66151-3.3TA5RG	3.3V	TO-263-5	800 Units / Reel
GM66151-3.3TB5TG	3.3V	TO-220-5	50 Units/Tube
GM66151-5.0TA5TG	5.0V	TO-263-5	50 Units/Tube
GM66151-5.0TA5RG	5.0V	TO-263-5	800 Units / Reel
GM66151-5.0TB5TG	5.0V	TO-220-5	50 Units/Tube
GM66151-12TA5TG	12V	TO-263-5	50 Units/Tube
GM66151-12TA5RG	12V	TO-263-5	800 Units / Reel
GM66151-12TB5TG	12V	TO-220-5	50 Units/Tube

Ordering Information – Pb Free

Ordering Number	Output Voltage	Package	Shipping
GM66152			
GM66152TA5T	Adj	TO-263-5	50 Units/Tube
GM66152TA5R	Adj	TO-263-5	800 Units / Reel
GM66152TB5T	Adj	TO-220-5	50 Units/Tube
GM66153			
GM66153TA5T	Adj	TO-263-5	50 Units/Tube
GM66153TA5R	Adj	TO-263-5	800 Units / Reel
GM66153TB5T	Adj	TO-220-5	50 Units/Tube

Ordering Information – Green Product

Ordering Number	Output Voltage	Package	Shipping
GM66152			
GM66152TA5TG	Adj	TO-263-5	50 Units/Tube
GM66152TA5RG	Adj	TO-263-5	800 Units / Reel
GM66152TB5TG	Adj	TO-220-5	50 Units/Tube
GM66153			
GM66153TA5TG	Adj	TO-263-5	50 Units/Tube
GM66153TA5RG	Adj	TO-263-5	800 Units / Reel
GM66153TB5TG	Adj	TO-220-5	50 Units/Tube

Absolute Maximum Ratings

Parameter	Symbol	Value	Unit
Power Dissipation	P_D	Internally Limited	W
Input Power Supply Voltage (Note 1)	V_{IN}	-20 to +60	V
Storage Temperature Range	T_{STG}	- 65 to 150	
Lead Temperature (Soldering, 5 sec)		+ 260	

Note 1: Maximum positive supply voltage of 60V must be of limited duration (<100msec) and duty cycle (< 1%). The maximum continuous supply voltage is 26V.

Operating Ratings

Parameter	Symbol	Value	Unit
Maximum Operating Input Voltage	V_{IN}	26	V
Operating Junction Temperature	T_J	-40 to +125	

Block Diagram

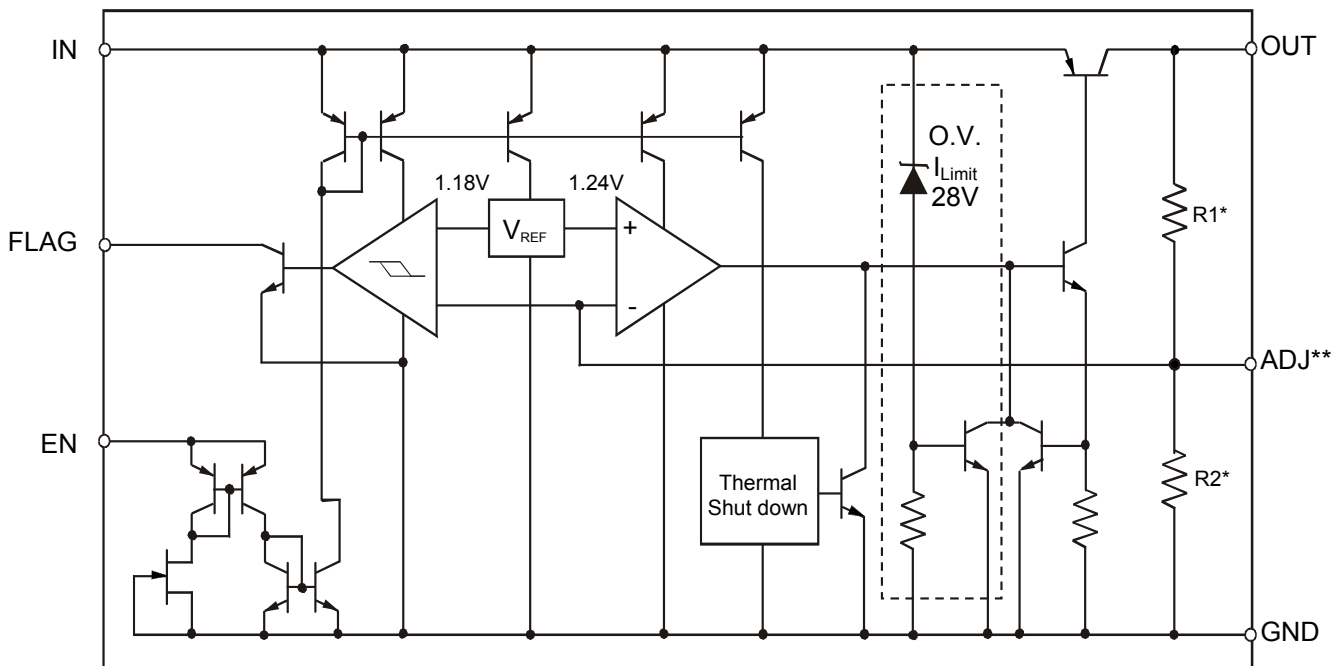

* Feedback network in fixed versions only
 ** Adjustable version only

Electrical Characteristics:

(Unless otherwise specified: $T_J = 25^\circ\text{C}$, Bold values are guaranteed across the full operating temperature range. Adjustable versions are programmed to 5.0V)

Parameter	Condition	Symbol	Min	Typ	Max	Unit	
Output Voltage	$I_O = 10\text{mA}$	V_{OUT}	-1		1	%	
	$10\text{mA} \leq I_O \leq 1.5\text{A}$, $V_{OUT} + 1\text{V} \leq V_{IN} \leq 26\text{V}$, (Note 2, 6)		-2		2		
Line Regulation	$I_O = 10\text{mA}$, $V_{OUT} + 1\text{V} \leq V_{IN} \leq 26\text{V}$	ΔV_{OI}		0.06	0.5	%	
Load Regulation	$V_{IN} = V_{OUT} + 5\text{V}$, $10\text{mA} \leq I_O \leq 1.5\text{A}$, (Note 6)	ΔV_{OL}		0.2	1.0	%	
Output Temperature Coefficient	(Note 6)	$\Delta V_{OUT} / \Delta T$		20	100	ppm/	
Dropout Voltage	$\Delta V_{OUT} = -1\%$ (Note 3)	V_{DO}		80	200	mV	
			$I_O = 100\text{mA}$		220		
			$I_O = 750\text{A}$		350		600
Ground Current (Note 5)	$I_O = 750\text{mA}$, $V_{IN} = V_{OUT} + 1\text{V}$	I_{GND}		8	20	mA	
	$I_O = 1.5\text{A}$			22			
Ground Pin Current at Dropout	$V_{IN} = 0.5\text{V}$ less than specified V_{OUT} , $I_O = 10\text{mA}$	I_{GNDDO}		20		mA	
Current Limit	GM66150, $V_{OUT} = 0\text{V}$, (Note 4)	I_{CL}		2.1	3.5	A	
Output Noise Voltage	10Hz to 100kHz, $I_L = 100\text{mA}$	e_n		400		μV_{RMS}	
			$C_L = 10\ \mu\text{F}$		260		
	$C_L = 33\ \mu\text{F}$						
Reference GM66152							
Reference Voltage		V_{REF}	1.228	1.240	1.252	V	
			1.215		1.265		
	(Note 8)		1.203		1.277		
Adjust Pin Bias Current		I_{ADJB}		40	80	nA	
					120		
V_{REF} Temperature Coefficient	(Note 7)	$\Delta V_{REF} / \Delta T$		20		ppm/	
Adjust Pin Bias Current Temperature Coefficient				0.1		nA/	

Electrical Characteristics (continued):

(Unless otherwise specified: $T_J = 25^\circ\text{C}$, Bold values are guaranteed across the full operating temperature range. Adjustable versions are programmed to 5.0V)

Parameter	Condition	Symbol	Min	Typ	Max	Unit
Flag Output (Error Comparator) GM66151/GM66153						
Output Leakage Current	$V_{OH} = 26\text{V}$	I_{OLEAK}		0.01	1 2	μA
Output Low Voltage	Device set for 5V, $V_{IN} = 4.5\text{V}$ $I_{OL} = 250\mu\text{A}$	V_{OL}		220	300 400	mV
Upper Threshold Voltage	Device set for 5V (Note 9)	V_{THU}	40 25	60		mV
Lower Threshold Voltage	Device set for 5V (Note 9)	V_{THL}		75	95 140	mV
Hysteresis	Device set for 5V (Note 9)	V_{HYS}		15		mV
Enable Input GM66151/GM66152						
Input Logic Voltage	Low (Off)				0.8	V
	High (On)		2.4			
Enable Pin Input Current	$V_{EN} = 26\text{V}$	I_{EN}		100	600 750	μA
	$V_{EN} = 0.8\text{V}$				2.5 5.0	
Regulator Output Current in Shutdown	(Note 10)	I_{OSD}		10	500	μA

Note 2: Full Load current (I_{FL}) is defined as 1.5A.

Note 3: Dropout voltage is defined as the input-to-output differential when the output voltage drops to 99% of its nominal value with V_{OUT} to V_{IN}

Note 4: $V_{IN} = V_{OUT} (\text{nominal}) + 1\text{V}$. For example, use $V_{IN} = 4.3\text{V}$ for a 3.3V regulator or use 6V for a 5V regulator. Employ pulse testing procedures to minimize temperature rise.

Note 5: Ground pin current is the regulator quiescent current. The total current drawn from the source is the sum of the load current plus the ground pin current.

Note 6: Output voltage temperature coefficient is defined as the worst case voltage change divided by the total temperature range.

Note 7: Thermal regulation is defined as the change in output voltage at a time T after a change in power dissipation is applied, excluding load or line regulation effects. Specifications are for a 200mA load pulse at $V_{IN} = 20\text{V}$ (a 4W pulse) for T = 10ms.

Note 8: $V_{REF} \leq V_{OUT} \leq (V_{IN} - 1\text{V})$, $2.3\text{V} \leq V_{IN} \leq 26\text{V}$, $10\text{mA} \leq I_L \leq I_{FL}$, $T_J \leq T_{JMAX}$.

Note 9: $V_{EN} \leq 0.8\text{V}$ and $V_{IN} \leq 26\text{V}$, $V_{OUT} = 0$

Note 10: When used in dual supply systems where the regulator load is returned to a negative supply, the output voltage must be diode clamped to ground.

Application Information

The GM66150 series is a high performance low-dropout voltage regulator suitable for all moderate to high current/voltage regulator applications. The 350mV dropout voltage at full load makes it especially valuable in battery powered systems and as high efficiency noise filters in “post-regulator” applications.

Unlike older NPN-pass transistor designs, dropout performance of the PNP output of these devices is limited merely by the low VCE saturation voltage. The GM66150 family of regulators is fully protected from damage due to fault conditions. Current limiting is provided. This limiting is linear; output current under overload conditions is constant.

Thermal shutdown disables the device when the die temperature exceeds the 125°C maximum safe operating temperature. Transient protection allows device survival even when the input voltage spikes between -20V and +60V. When the input voltage exceeds about 35V to 40V, the over voltage sensor temporarily disables the regulator.

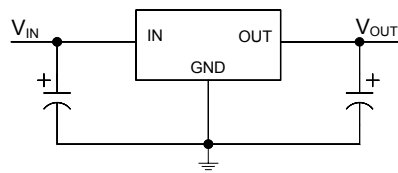

Figure 1. Linear regulators require only two capacitors for operation.

Thermal Design

Linear regulators are simple to use. The most complicated design parameters to consider are thermal characteristics. Thermal design requires the following application-specific parameters:

- Maximum ambient temperature, T_A
- Output Current, I_{OUT}
- Output Voltage, V_{OUT}
- Input Voltage, V_{IN}

First, we calculate the power dissipation of the regulator from these numbers and the device parameters from this datasheet.

$$P_D = I_{OUT} \times (1.01V_{IN} - V_{OUT}), \text{ Where the ground current is approximated by 1\% of } I_{OUT}.$$

Then the heat sink thermal resistance is determined with this formula:

$$\theta_{SA} = \frac{T_{JMAX} - T_A}{P_D} - (\theta_{JC} + \theta_{CS}), \text{ where } T_{JMAX} \leq 125^\circ\text{C and } \theta_{CS} \text{ is between } 0 \text{ and } 20^\circ\text{C/W}$$

Capacitor Requirements

For stability and minimum output noise, a capacitor on the regulator output is necessary. The value of this capacitor is dependent upon the output current; lower currents allow smaller capacitors. GM66150 series are stable with the 10µF minimum capacitor values at full load. Where the regulator is powered from a source with a high AC impedance, a 0.1µF capacitor connected between Input and GND is recommended. This capacitor should have good characteristics to above 250kHz.

Application Information (continued)

Minimum Load Current

The GM66150 regulators are specified between finite loads. If the output current is too small, leakage currents dominate and the output voltage rises. The 5mA minimum load current swamps any expected leakage current across the operating temperature range.

Adjustable Regulator Design

The adjustable regulator versions, GM66152 and GM66153, allow programming the output voltage anywhere between 1.25V and the 26V maximum operating rating of the family. Two resistors are used. Resistors can be quite large, up to 1M., because of the very high input impedance and low bias current of the sense comparator: The resistor values are calculated by:

$$R1 = R2 \left(\frac{V_{OUT}}{1.24} - 1 \right)$$

Where V_{OUT} is the desired output voltage. Figure 2 shows component definition. Applications with widely varying load currents may scale the resistors to draw the minimum load current required for proper operation.

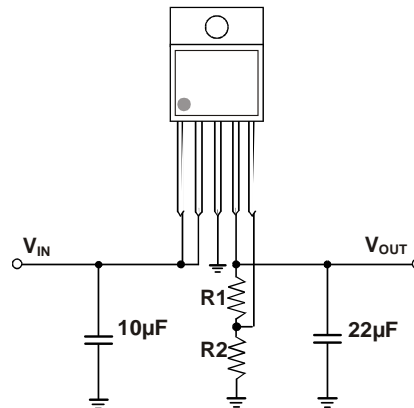

Figure 2. Adjustable Regulator with Resistors

Error Flag

GM66151 and GM66153 versions feature an Error Flag, which looks at the output voltage and signals an error condition when this voltage drops 5% below its expected value. The error flag is an open-collector output that pulls low under fault conditions. It may sink 10mA. Low output voltage signifies a number of possible problems, including an over-current fault (the device is in current limit) and low input voltage. The flag output is inoperative during over temperature shutdown conditions.

Enable Input

GM66151 and GM66152 versions feature an enable (EN) input that allows ON/OFF control of the device. Special design allows zero current drain when the device is disabled—only microamperes of leakage current flows. The EN input has TTL/CMOS compatible thresholds for simple interfacing with logic, or may be directly tied to $\leq 30V$. Enabling the regulator requires approximately 20µA.

Typical Characteristics (GM66150)

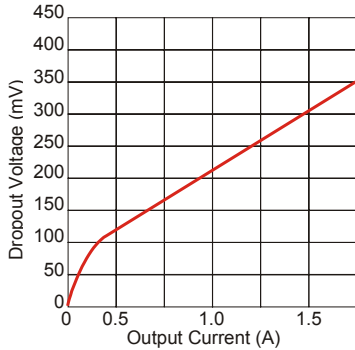

Figure 1. GM66150 Dropout Voltage vs. Output Current

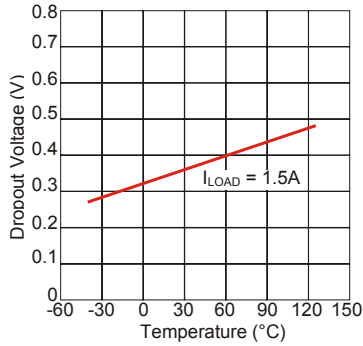

Figure 2. GM66150 Dropout Voltage vs. Temperature

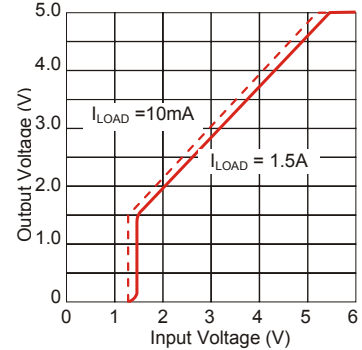

Figure 3. GM66150-5.0 Dropout Characteristics

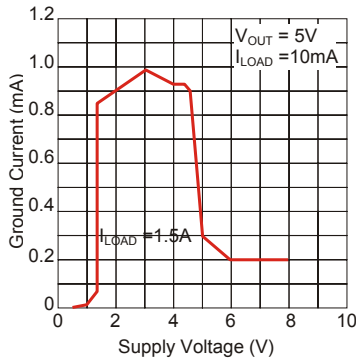

Figure 4. GM66150 Ground Current vs. Supply Voltage

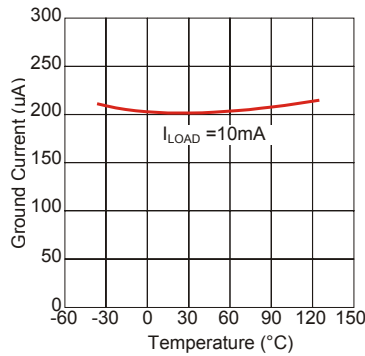

Figure 5. GM66150 Ground Current vs. Temperature

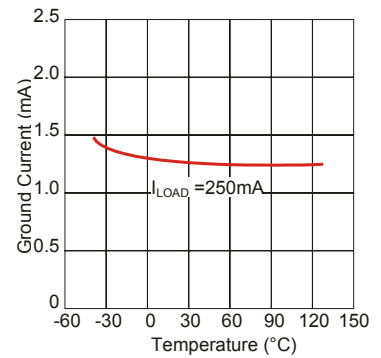

Figure 6. GM66150 Ground Current vs. Temperature

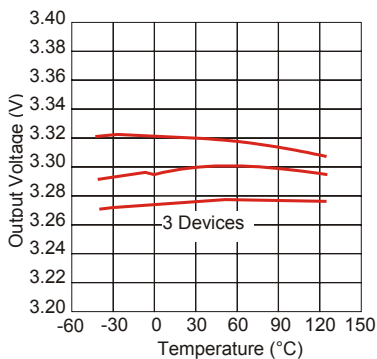

Figure 7. GM66150-3.3 Output Voltage vs. Temperature

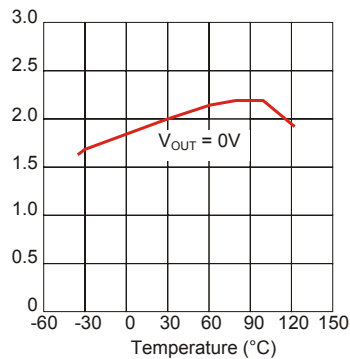

Figure 8. GM66150-3.3 Short Circuit Current vs. Temperature

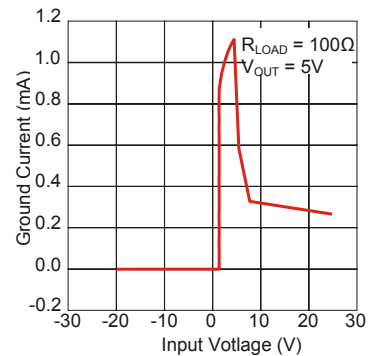
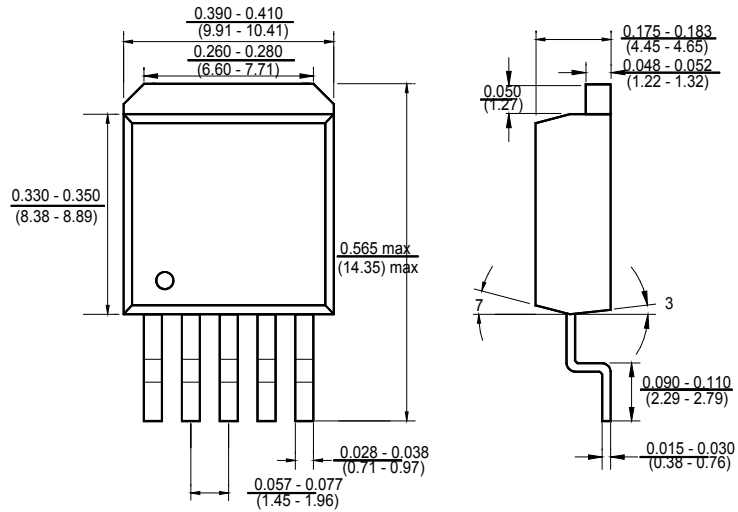
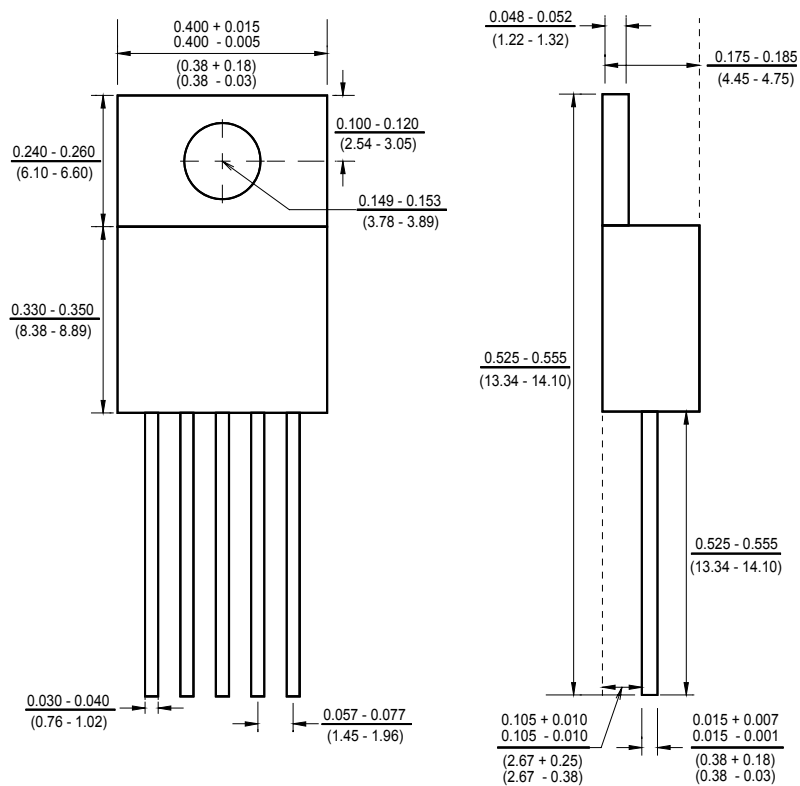

Figure 9. GM66150 Ground Current vs. Input Voltage

Package Outline Dimensions – TO-263-5



Package Outline Dimensions – TO-220-5



Package Outline Dimensions – TO263

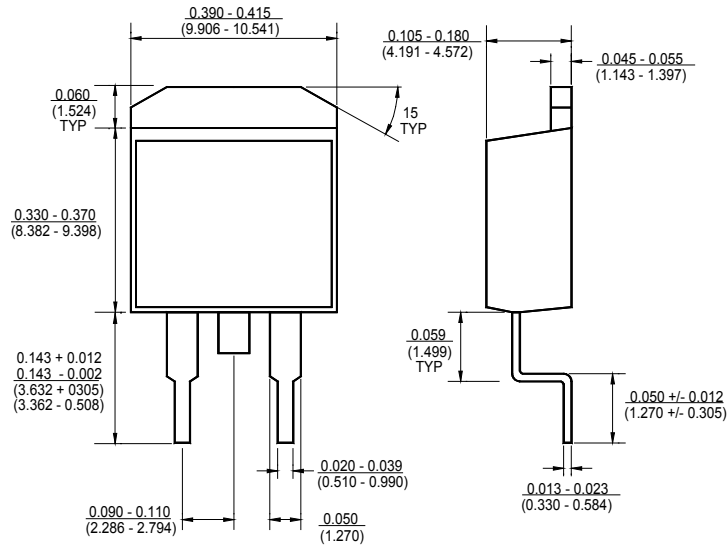

Ordering Number

<u>GM 66150</u> -<u>1.5</u>		<u>TA3</u>	<u>R</u>	<u>G</u>
APM Gamma Micro	Circuit Type	Output Voltage	Package Type	Shipping Type
		1.5 = 1.5V 1.8 = 1.8V 2.5 = 2.5V 3.0 = 3.0V 3.3 = 3.3V 5.0 = 5.0V 12 = 12.0V	TA3: TO263 TB3: TO220	R:Taping & Reel T: Tube
				Blank: Pb-free G:Green

<u>GM 66151</u> -<u>1.5</u>		<u>TA5</u>	<u>R</u>	<u>G</u>
APM Gamma Micro	Circuit Type	Output Voltage	Package Type	Shipping Type
		1.5 = 1.5V 1.8 = 1.8V 2.5 = 2.5V 3.0 = 3.0V 3.3 = 3.3V 5.0 = 5.0V 12 = 12.0V	TA5: TO263-5 TB5: TO220-5	R:Taping & Reel T:Tube
				Blank: Pb-free G:Green

<u>GM 66152</u> -<u>A</u>		<u>TA5</u>	<u>R</u>	<u>G</u>
APM Gamma Micro	Circuit Type	Output Voltage	Package Type	Shipping Type
		Adj	TA3: TO263-5 TB3: TO220-5	R: Taping & Reel T: Tube
				Blank: Pb-free G:Green

<u>GM 66153</u> -<u>A</u>		<u>TA5</u>	<u>R</u>	<u>G</u>
APM Gamma Micro	Circuit Type	Output Voltage	Package Type	Shipping Type
		Adj	TA3: TO263-5 TB3: TO220-5	R: Taping & Reel T: Tube
				Blank: Pb-free G:Green