

Part No./型号: **515PWO4C**



**ATTENTION**  
OBSERVE PRECAUTIONS  
FOR HANDLING  
ELECTROSTATIC  
DISCHARGE  
SENSITIVE  
DEVICES

**Features/特征:**

- Single color/特征
- High bright output/高亮度输出
- Low power consumption/低功耗
- High reliability and long life/可靠性高、寿命长
- Low brightness declines/低光衰

**Descriptions/描述:**

- Dice material/芯片材质: GaInN
- Emitting Color/发光颜色:  
Super Bright White/高亮度白色
- Device Outline/产品外形:  
φ5mm Round Type/5mm 圆形
- Lens Type/胶体颜色: Water Clear/无色透明

**Directivity/指向特性:**

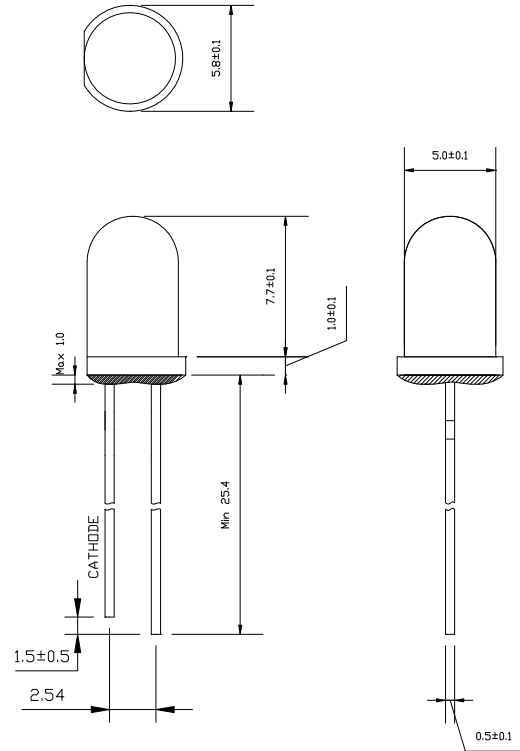

**NOTE/注意:**

- All dimensions are millimeters/单位: mm
- Tolerance is +/-0.25mm unless otherwise noted/没有标注的公差为±0.25mm

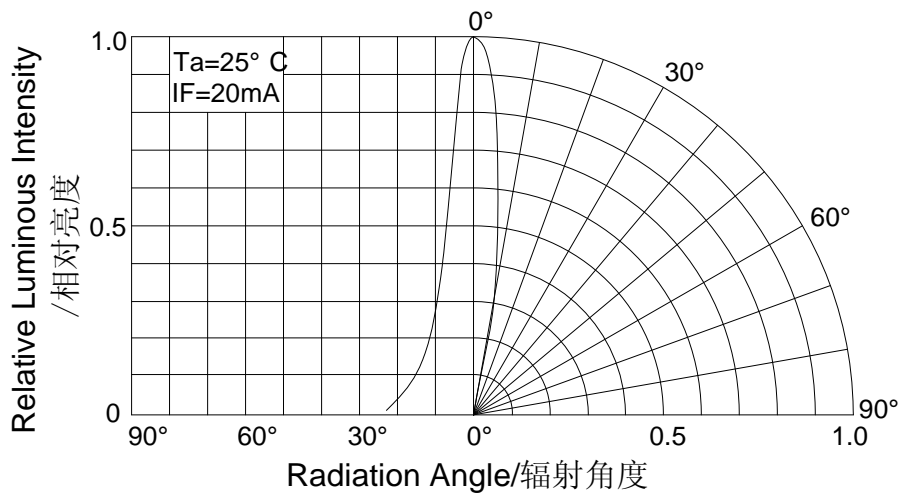

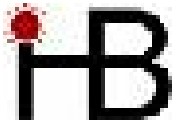

Part No./型号: 515PWO4C

**Absolute maximum ratings/极限参数 (Ta = 25°C)**

Parameter 参数	Symbol 符号	Test Condition 测试条件	Value 数值		Unit 单位
			Min.	Max.	
Reverse Voltage 反向电压	V <sub>R</sub>	I <sub>R</sub> = 30 μ A	5	--	V
Forward Current 正向工作电流	I <sub>F</sub>	----	----	25	mA
Power Dissipation 损耗功率	P <sub>d</sub>	----	----	108	mW
Pulse Current 正向峰值电流	I <sub>peak</sub>	Duty=0.1mS, 1kHz	----	100	mA
Operating Temperature 工作温度范围	T <sub>opr</sub>	----	-40	+85	°C
Storage Temperature 储存温度范围	T <sub>str</sub>	----	-40	+100	°C

**Electrical and optical characteristics /光电参数 (Ta = 25°C)**

Parameter 参数	Symbol 符号	Test Condition 测试条件	Value 数值			Unit 单位
			Min.	Typ.	Max.	
Forward Voltage 正向电压	V <sub>F</sub>	I <sub>F</sub> = 20mA	----	3.2	3.6	V
Reverse Current 反向电流	I <sub>R</sub>	V <sub>R</sub> = 5V	----	----	30	μ A
Luminous Intensity 发光强度	I <sub>v</sub>	I <sub>F</sub> = 20mA	----	11000	----	mcd
Viewing Angle 指向角度	2 θ 1/2	I <sub>F</sub> = 20mA	13		17	Deg.

**Luminous Intensity Bins Chart/发光强度分档 (Ta = 25°C)**

Bin	Y	Z1	Z2	Z3	Z4
Min	6000	8000	10000	12000	15000
Max	8000	10000	12000	15000	18000

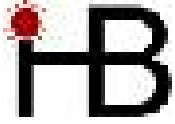

Part No./型号: 515PWO4C

**Color Temperature Bins Char/色温分档 (Ta = 25°C)**

Bin	WP0	WP1	WP2	WP3	WP4
CCT	<2500	2500~2800	2800~3000	3000~3300	3300~3600
Bin	WP5	WP6	WP7	WP8	WP9
CCT	3600~4000	4000~4500	4500~5000	5000~6000	>6000

**Typical electrical/optical characteristic curves/光电特性曲线:**

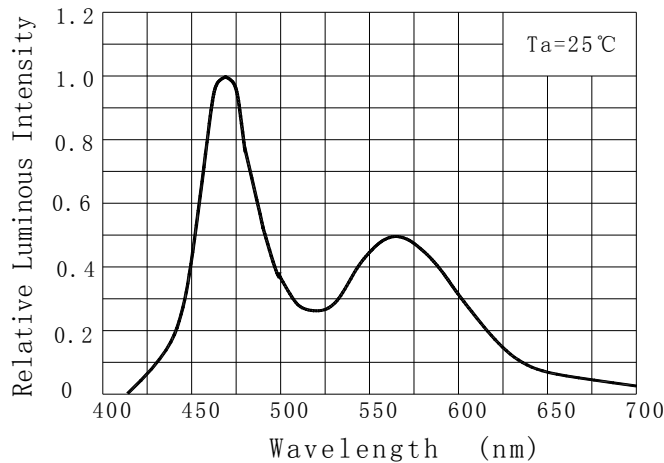
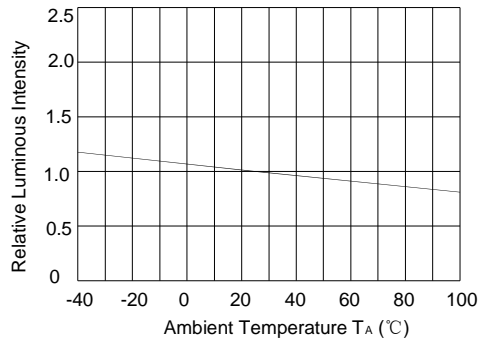
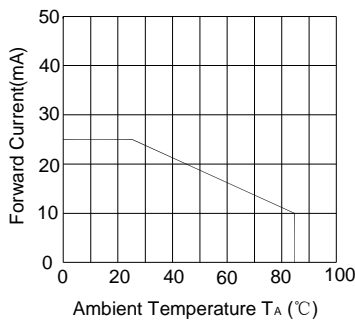
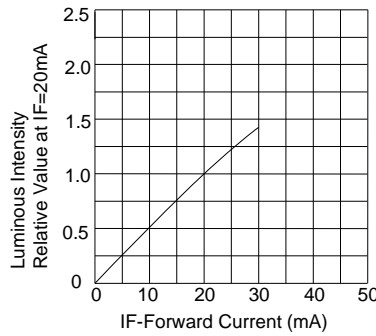
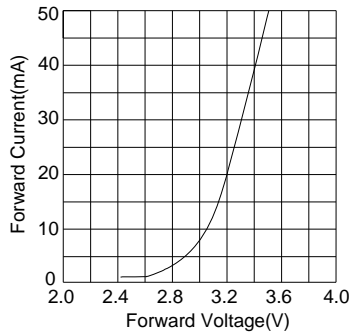



Part No./型号: 515PWO4C

**Life Test curves /寿命测试曲线**

