



CHENMKO ENTERPRISE CO.,LTD

CHIMD3PT

SURFACE MOUNT

Dual Digital Silicon Transistor

VOLTAGE 50 Volts CURRENT 50 mAmpere

Lead free devices

APPLICATION

* Switching circuit, Inverter, Interface circuit, Driver circuit.

FEATURE

- * Small surface mounting type. (SC-74/SOT-457)
- * High current gain.
- * Suitable for high packing density.
- * Low collector-emitter saturation.
- * High saturation current capability.
- * Both the CHDTA114E & CHDTC114E in one package.
- * Built in bias resistor(R1=10kΩ, Typ.)

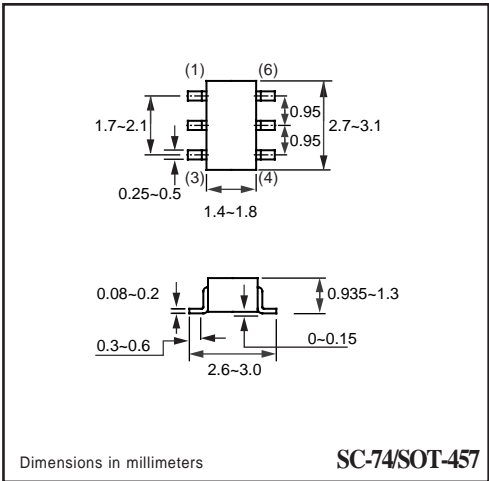
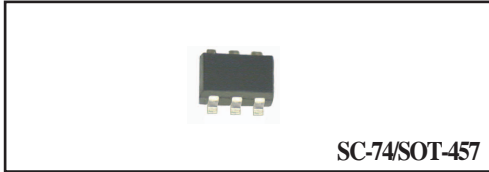

CIRCUIT

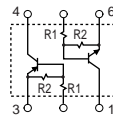

CHDTA114E LIMITING VALUES

In accordance with the Absolute Maximum Rating System (IEC 60134).

SYMBOL	PARAMETER	CONDITIONS	MIN.	MAX.	UNIT
V _{CC}	Supply voltage		-	-50	V
V _{IN}	Input voltage		-40	+10	V
I _o	DC Output current		-	-50	mA
I _{C(Max.)}			-	-100	
P _{TOT}	Total power dissipation	T _{amb} ≤ 25 °C, Note 1	-	300	mW
T _{STG}	Storage temperature		-55	+150	°C
T _J	Junction temperature		-	150	°C

Note

Transistor mounted on an FR4 printed-circuit board.

CHDTC114E LIMITING VALUES

In accordance with the Absolute Maximum Rating System (IEC 60134).

SYMBOL	PARAMETER	CONDITIONS	MIN.	MAX.	UNIT
V _{CC}	Supply voltage		–	50	V
V _{IN}	Input voltage		-10	+40	V
I _O	DC Output current		–	50	mA
I _{C(Max.)}			–	100	
P _{TOT}	Total power dissipation	T _{amb} ≤ 25 °C, Note 1	–	150	mW
T _{STG}	Storage temperature		-55	+150	°C
T _J	Junction temperature		–	150	°C

Note

Transistor mounted on an FR4 printed-circuit board.

CHDTA114E CHARACTERISTICS

T_{amb} = 25 °C unless otherwise specified.

SYMBOL	PARAMETER	CONDITIONS	MIN.	TYP.	MAX.	UNIT
V _{I(off)}	Input off voltage	I _O =-100uA; V _{CC} =-5.0V	-0.5	–	–	V
V _{I(on)}	Input on voltage	I _O =-10mA; V _O =-0.3V	–	–	-3.0	V
V _{O(on)}	Output voltage	I _O =-10mA; I _I =-0.5mA	–	0.1	-0.3	V
I _I	Input current	V _I =-5V	–	–	-0.88	mA
I _{C(off)}	Output current	V _I =0V; V _{CC} =-50V	–	–	-0.5	uA
h _{FE}	DC current gain	I _O =-5mA; V _O =-5.0V	30	–	–	
R ₁	Input resistor		7.0	10.0	13.0	KΩ
R _{2/R₁}	Resistor ratio		0.8	1.0	1.2	
f _T	Transition frequency	I _E =5mA, V _{CE} =-10.0V f=100MHz	–	250	–	MHz

Note

Pulse test: t_p≤300uS; δ≤0.02.

CHDTC114E CHARACTERISTICS

T_{amb} = 25 °C unless otherwise specified.

SYMBOL	PARAMETER	CONDITIONS	MIN.	TYP.	MAX.	UNIT
V _{I(off)}	Input off voltage	I _O =100uA; V _{CC} =5.0V	0.5	–	–	V
V _{I(on)}	Input on voltage	I _O =10mA; V _O =0.3V	–	–	3.0	V
V _{O(on)}	Output voltage	I _O =10mA; I _I =0.5mA	–	0.1	0.3	V
I _I	Input current	V _I =5V	–	–	0.88	mA
I _{C(off)}	Output current	V _I =0V; V _{CC} =50V	–	–	0.5	uA
h _{FE}	DC current gain	I _O =5mA; V _O =5.0V	30	–	–	
R ₁	Input resistor		7.0	10.0	13.0	KΩ
R _{2/R₁}	Resistor ratio		0.8	1.0	1.2	
f _T	Transition frequency	I _E =-5mA, V _{CE} =10.0V f=100MHz	–	250	–	MHz

Note

Pulse test: t_p≤300uS; δ≤0.02.

RATING CHARACTERISTIC CURVES (CHIMD3PT)

CHDTA114E Typical Electrical Characteristics

Fig.1 Input voltage vs. output current (ON characteristics)

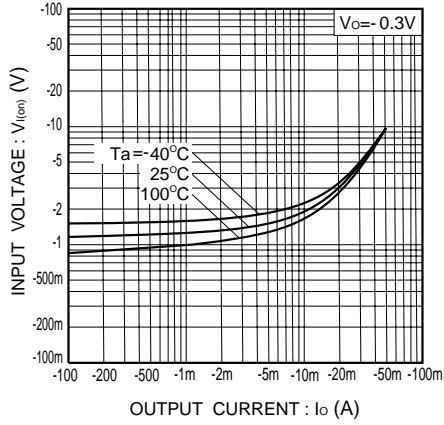

Fig.2 Output current vs. input voltage (OFF characteristics)

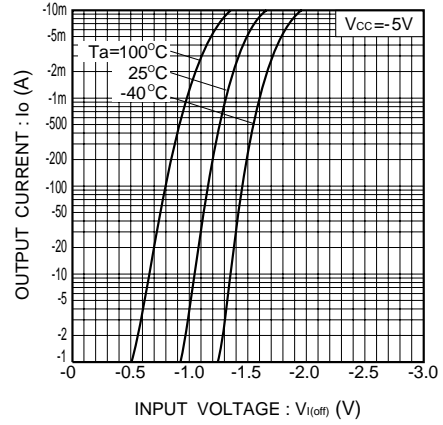

Fig.3 DC current gain vs. output current

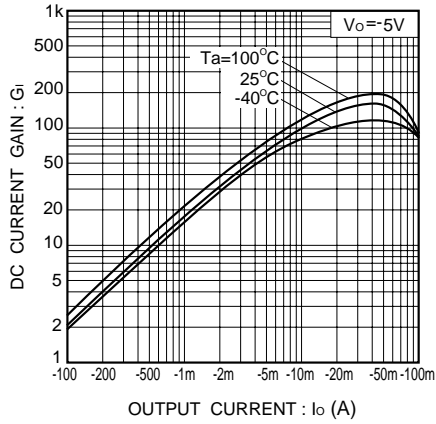
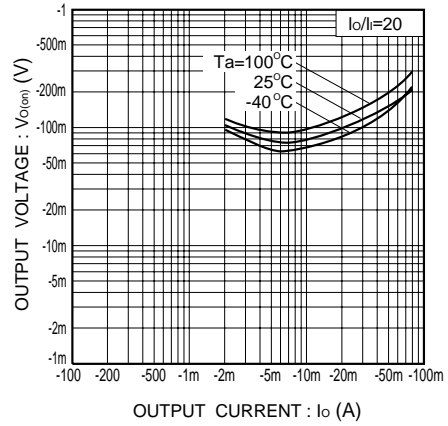

Fig.4 Output voltage vs. output current



RATING CHARACTERISTIC CURVES (CHIMD3PT)

CHDTC114E Typical Electrical Characteristics

Fig.1 Input voltage vs. output current (ON characteristics)

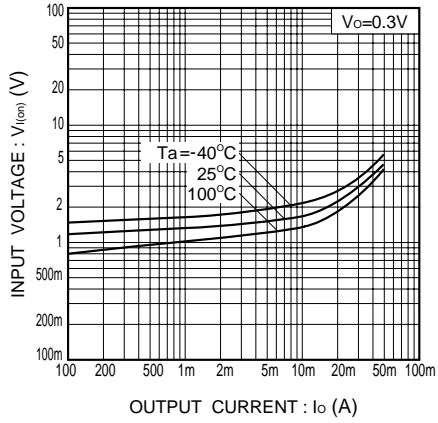

Fig.2 Output current vs. input voltage (OFF characteristics)

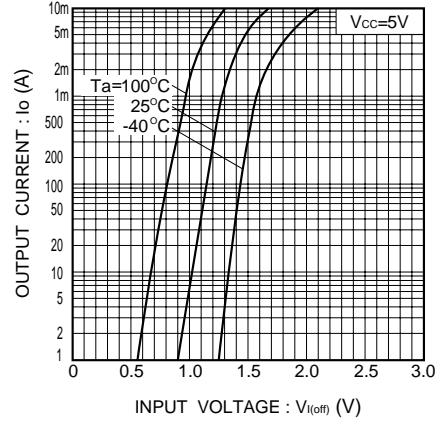

Fig.3 DC current gain vs. output current

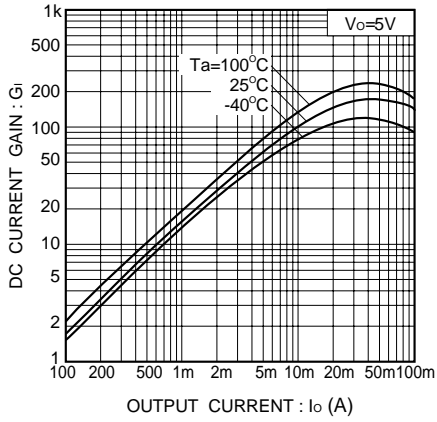

Fig.4 Output voltage vs. output current

