

Features

- LO 2 TO 18 GHz
- RF 2 TO 18 GHz
- IF 1 TO 8 GHz
- LO DRIVE: +13 dBm (NOMINAL)
- WIDE BANDWIDTH

Description

M88 is a triple balanced mixer, designed for use in military, commercial and test equipment applications. The design utilizes Schottky ring quad diodes and broadband soft dielectric baluns to attain excellent performance. The use of high temperature solder assembly processes used internally makes it ideal for use in manual, semi-automated assembly. Environmental screening available to MIL-STD-883, MIL-STD-202 or MIL-DTL-28837, consult factory.

Product Image

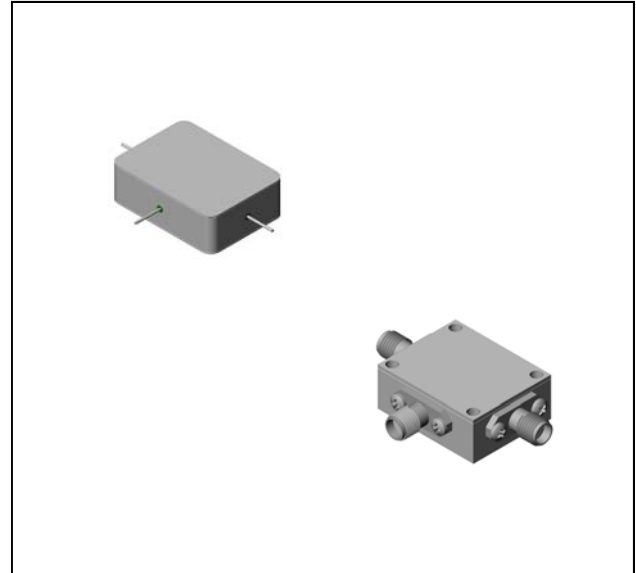

Ordering Information

Part Number	Package
M88	Minpac
M88C	SMA Connectorized

Electrical Specifications: $Z_0 = 50\Omega$ $Lo = +13$ dBm (Downconverter Application only)

Parameter	Test Conditions	Units	Typical	Guaranteed	
				+25°C	-54° to +85°C
SSB Conversion Loss (max) & SSB Noise Figure (max)	fR = 2 to 10 GHz, fL = 2 to 18 GHz, fI = 1 to 8 GHz fR = 10 to 18 GHz, fL = 10 to 18 GHz, fI = 2 to 8 GHz fR = 10 to 18 GHz, fL = 2 to 10 GHz, fI = 2 to 8 GHz	dB	7.5	10.0	10.5
			8.0	10.5	11.0
			8.0	11.0	11.5
Isolation, L to R (min)	fL = 2 to 18 GHz	dB	28	15	13
Isolation, L to I (min)	fL = 2 to 18 GHz	dB	32	16	14
1 dB Conversion Comp.	fL = +13 dBm	dBm	+7		
Input IP3	fR1 = 6 GHz at -3 dBm, fR2 = 6.01 GHz at -3 dBm, fL = 10 GHz at +13 dBm fR1 = 15 GHz at -3 dBm, fR2 = 15.01 GHz at -3 dBm, fL = 18 GHz at +13 dBm	dBm	+18.5		
			+22		

Typical Performance Curves

Conversion Loss vs. Drive Power

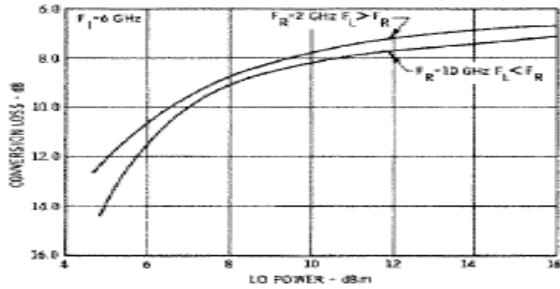

Conversion Loss vs. Frequency, LO @ +13 dBm

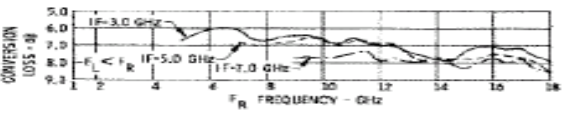
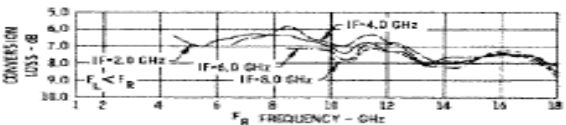
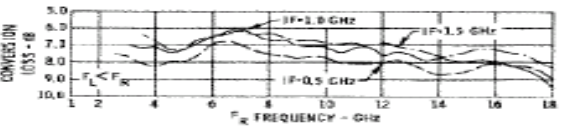
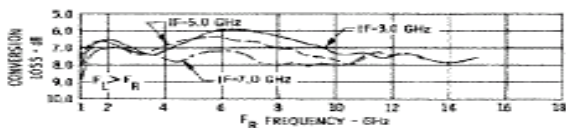
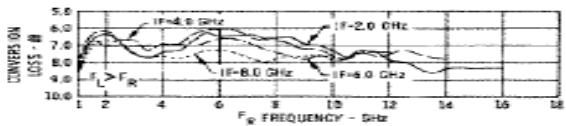
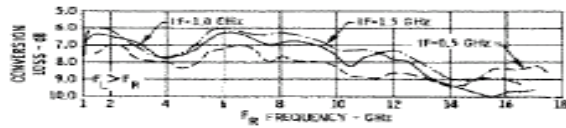

R-Port VSWR LO @ +13 dBm

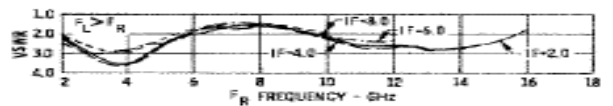
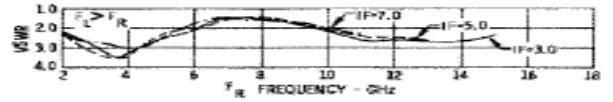
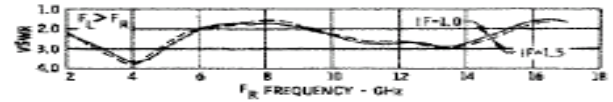

R-Port VSWR LO @ +13 dBm

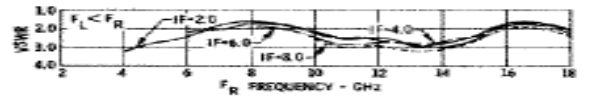
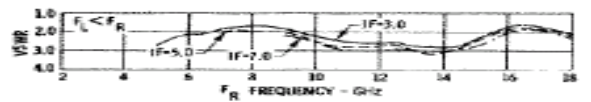
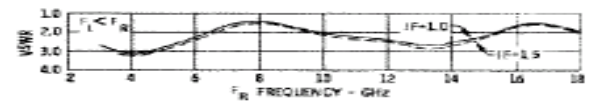

I-Port VSWR vs. Frequency LO @ +13 dBm

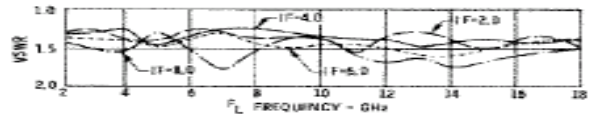
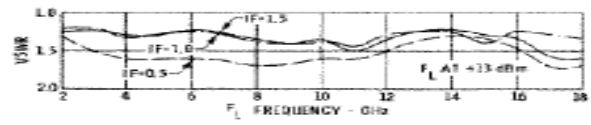

ADVANCED: Data Sheets contain information regarding a product M/A-COM Technology Solutions is considering for development. Performance is based on target specifications, simulated results, and/or prototype measurements. Commitment to develop is not guaranteed.
PRELIMINARY: Data Sheets contain information regarding a product M/A-COM Technology Solutions has under development. Performance is based on engineering tests. Specifications are typical. Mechanical outline has been fixed. Engineering samples and/or test data may be available. Commitment to produce in volume is not guaranteed.

• **North America** Tel: 800.366.2266 • **Europe** Tel: +353.21.244.6400
 • **India** Tel: +91.80.4155721 • **China** Tel: +86.21.2407.1588
 Visit www.macomtech.com for additional data sheets and product information.

M/A-COM Technology Solutions Inc. and its affiliates reserve the right to make changes to the product(s) or information contained herein without notice.

Absolute Maximum Ratings

Parameter	Absolute Maximum
Operating Temperature	-54°C to +100°C
Storage Temperature	-65°C to +100°C
Peak Input Power	+26 dBm max @ +25°C +23 dBm max @ +100°C
Peak Input Current	100 mA DC

Isolation vs Frequency

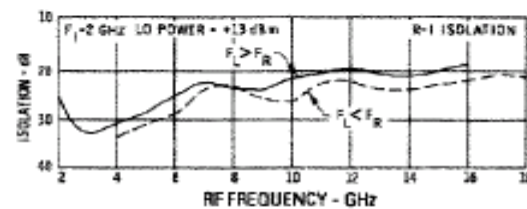
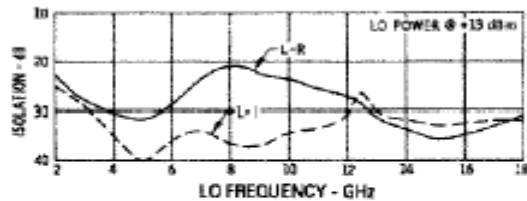

L-Port VSWR

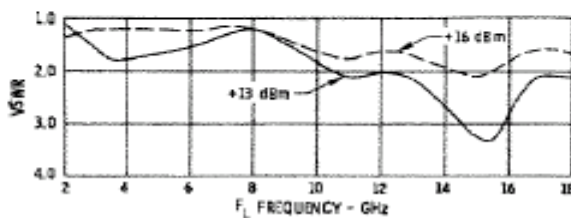

Conversion Loss vs. Frequency & Temperature LO @ +13 dBm

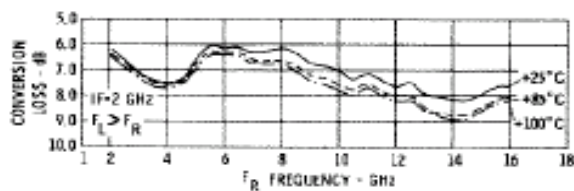

Outline Drawing: Minpac *

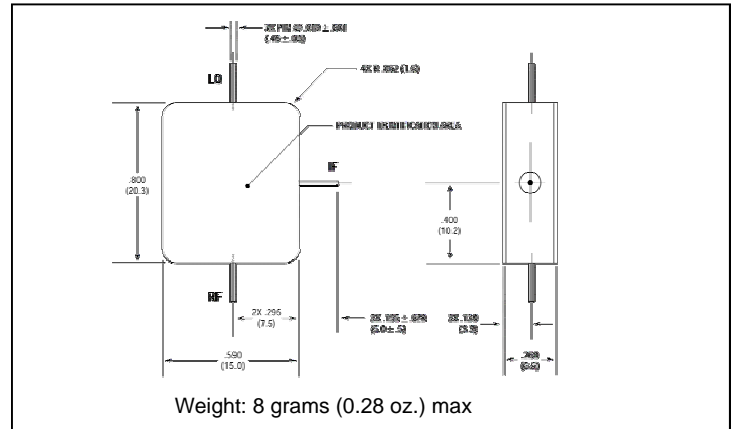

Outline Drawing: SMA Connectorized *

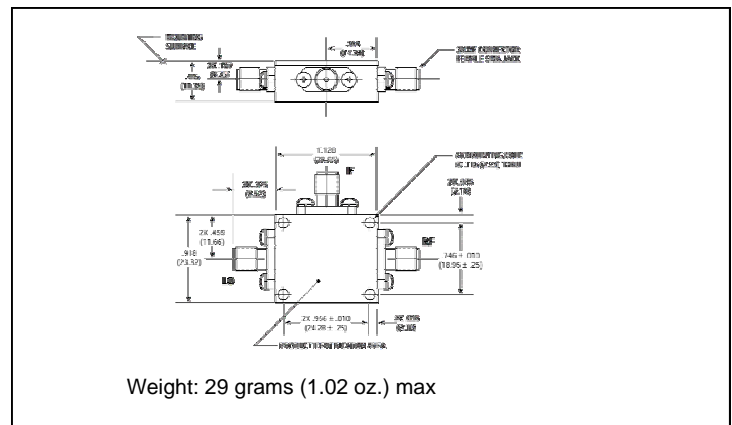

* Dimensions are inches (millimeters) ±0.015 (0.38) unless otherwise specified.