

FEATURES

- -40°C to $+85^{\circ}\text{C}$ operation
- 16 to 40 VDC input
(19 to 40 VDC input for 15 volt output models)
- Fully Isolated
- Optocoupler feedback
- 600 kHz typical operating frequency
- Topology – Single Ended Forward
- 50 V for up to 50 ms transient protection
- Inhibit function
- Indefinite short circuit protection
- Up to 83% efficiency

DC/DC CONVERTERS 28 VOLT INPUT



HR120 SERIES 12 WATT

MODELS	
VDC OUTPUT	
SINGLE	DUAL
5	± 12
12	± 15
15	

Size (max.): 1.460 x 1.130 x 0.330 inches (37.08 x 28.70 x 8.38 mm)

See Section B8, case E1 for dimensions.

Weight: 21 grams typical.

Screening: Standard only. See Section C2 for screening description.

DESCRIPTION

The HR120 Series™ of DC/DC converters offers up to 12 watts of power from single or dual outputs in a single package over a -40°C to $+85^{\circ}\text{C}$ temperature range. Thick film hybrid manufacturing technology produces high levels of miniaturization, giving the HR120 Series converters a low profile (0.330 inch), small board area (1.65 square inches), and high power density (22 watt/in³).

The parts are packaged in sealed steel enclosures, making them ideal for use in high reliability applications. Each unit is guaranteed to pass a hermeticity test with a maximum leak rate of 0.001 atm-cc/sec.

DESIGN METHODOLOGY

The HR120 converters are switching regulators which use a quasi-square wave, single ended forward converter design with a nominal switching frequency of 600 kHz. Isolation between input and output circuits is provided with a transformer in the forward power loop and a temperature insensitive optical link in the feedback control loop. Output regulation is accomplished with constant frequency pulse width modulation. Both line and load regulation are typically within 10 mV.

On dual output models, the positive output is independently regulated and the negative output is cross-regulated. Figures 7 and 8 illustrate what effects load changes have on the negative output.

Indefinite short circuit protection and overload protection are provided by sensing output load current and restricting the output current to approximately 125% of full load output current. Since the output current is sensed in the secondary stage, the result is a predictable, constant output current control with no foldback characteristics. HR120 converters are provided with internal filtering elements on both the input and output to help reduce the need for external components.

WIDE VOLTAGE RANGE

The 5 and 12 volt output models provide full power operation over the input voltage range of 16 to 40 volts (19 to 40 volts for 15 volt output models). Operation below 16 volts (or below 19 volts for the 15 volt output models), including operation in MIL-STD-704E emergency power conditions, is possible with derated output power. Please refer to the low voltage drop-out graphs, Figures 9 and 10.

The HR120 Series provides full power operation at case temperatures from -40°C up to $+85^{\circ}\text{C}$. Depending on operating levels, air flow, and ambient temperature, heat sinking may be required.

INHIBIT FEATURE

An inhibit terminal is provided that can be used to disable internal switching, resulting in a very low quiescent input current. An open collector TTL compatible low ($\leq 0.8\text{ V}$) is required to control the inhibit function. This level may be supplied by an open collector gate since the inhibit pin is provided with an internal pull-up resistor.

HR120 SERIES 12 WATT

DC/DC CONVERTERS

ABSOLUTE MAXIMUM RATINGS

Input Voltage

- 16 to 40 VDC
- 19 to 40 VDC 15 volt outputs

Output Power

- 12 watts (10 watts HR121-2805)

Lead Soldering Temperature (10 sec per pin)

- 300°C

Storage Temperature Range (Case)

- -55°C to +125°C

INHIBIT

Inhibit TTL Open Collector

- Logic low (output disabled)
Logic low 0.8 V max
Inhibit pin current 4 mA max
- Referenced to input common
- Logic high (output enabled)
Open collector

TYPICAL CHARACTERISTICS

Output Voltage Temperature Coefficient

- 150 ppm/°C, typical

Input to Output Capacitance

- 50 pF, typical

Current Limit

- 125% of full load, typical

Isolation

- 100 megohm minimum at 500 V

Conversion Frequency

- 600 kHz typical

Inhibit Pin Voltage (unit enabled)

- 8 to 11 V

RECOMMENDED OPERATING CONDITIONS

Input Voltage Range

- 16 to 40 VDC continuous
- 19 to 40 VDC continuous 15 volt outputs
- 50 V for 50 msec transient

Case Operating Temperature (Tc)

- -40°C to +85°C full power

Electrical Characteristics: 25°C Tc, 28 VDC Vin, 100% load, unless otherwise specified.

SINGLE OUTPUT MODELS		HR121-2805			HR121-2812			HR121-2815			UNITS
PARAMETER	CONDITIONS	MIN	TYP	MAX	MIN	TYP	MAX	MIN	TYP	MAX	
OUTPUT VOLTAGE		4.95	5.0	5.05	11.88	12	12.12	14.85	15	15.15	VDC
OUTPUT CURRENT		—	—	2.0	—	—	1.0	—	—	0.8	A
OUTPUT POWER	MIN. TO MAX. V _{IN}	—	—	10	—	—	12	—	—	12	W
OUTPUT RIPPLE	10 kHz to 2 MHz	—	40	60	—	30	60	—	25	50	mV p-p
LINE REGULATION	MIN. TO MAX. V _{IN}	—	10	50	—	10	50	—	10	50	mV
LOAD REGULATION	NO LOAD TO FULL	—	10	50	—	10	50	—	10	50	mV
INPUT VOLTAGE	NO LOAD TO FULL	16	28	40	16	28	40	19	28	40	VDC
	TRANSIENT 50 ms	—	—	50	—	—	50	—	—	50	
INPUT CURRENT	NO LOAD	—	20	30	—	20	30	—	20	30	mA
	FULL LOAD	—	—	478	—	—	548	—	—	535	
	INHIBITED	—	2	3	—	2	3	—	2	3	
INPUT RIPPLE CURRENT	10 kHz TO 2 MHz	—	135	180	—	150	200	—	150	220	mA p-p
EFFICIENCY		74	77	—	77	81	—	80	83	—	%
LOAD FAULT ¹	POWER DISSIPATION										W
	OVERLOAD	—	—	5	—	—	5	—	—	5	
	SHORT CIRCUIT	—	—	3.5	—	—	2.8	—	—	2	
START-UP	DELAY	—	180	300	—	80	200	—	150	250	ms

Notes

1. Indefinite short circuit protection not guaranteed above 85°C case temperature.

DC/DC CONVERTERS

HR120 SERIES 12 WATT

Electrical Characteristics: 25°C Tc, 28 VDC Vin, 100% load, unless otherwise specified.

DUAL OUTPUT MODELS		HR122-2812			HR122-2815			UNITS
PARAMETER	CONDITION	MIN	TYP	MAX	MIN	TYP	MAX	
OUTPUT VOLTAGE	+V _{OUT}	11.88	12.0	12.12	14.85	15.0	15.15	VDC
	-V _{OUT}	11.82	12.0	12.18	14.77	15.0	15.23	
OUTPUT CURRENT ^{1, 2}		—	0.5	1.0	—	0.4	0.8	A
OUTPUT POWER ²	+V _{OUT}	—	—	10.8	—	—	10.8	W
	-V _{OUT}	—	—	10.8	—	—	10.8	
	TOTAL	—	—	12	—	—	12	
OUTPUT RIPPLE VOLTAGE	10 kHz TO 2 MHz	—	30	60	—	30	60	mV p-p
LINE REGULATION	+V _{OUT}	—	5	50	—	5	50	mV
MIN. TO MAX. V _{IN}	-V _{OUT}	—	30	150	—	30	150	
LOAD REGULATION	+V _{OUT}	—	5	50	—	10	50	mV
NO LOAD TO FULL	-V _{OUT}	—	30	150	—	30	150	
CROSS REGULATION	20% TO 80% LOAD ³	—	5	10	—	4	8	%
	50% LOAD ⁴	—	4	5	—	3	5	
INPUT VOLTAGE	CONTINUOUS	16	28	40	19	28	40	VDC
	TRANSIENT 50 ms	—	—	50	—	—	50	
INPUT CURRENT	NO LOAD	—	25	35	—	25	35	mA
	FULL LOAD	—	—	545	—	—	540	
	INHIBITED	—	1.9	3	—	1.9	3	
INPUT RIPPLE CURRENT	10 kHz TO 2 MHz	—	175	240	—	175	240	mA p-p
EFFICIENCY		78	81	—	80	83	—	%
LOAD FAULT ⁵	POWER DISSIPATION							W
	OVERLOAD	—	—	2.8	—	—	2	
	SHORT CIRCUIT	—	—	5	—	—	5	
START-UP	DELAY	—	150	250	—	150	250	ms

Notes

- Applies to both outputs.
- Maximum combined output power is 12 watts. A maximum of 90% is available from either output.
- 20% to 80% load on the positive output and 80% to 20% on the negative output. See Figure 8.
- 50% load on the positive output and 50% to 20% load on the negative output. 50% load on the negative output and 50% to 20% load on the positive output. See Figure 7.
- Indefinite short circuit protection not guaranteed above 85°C case temperature.

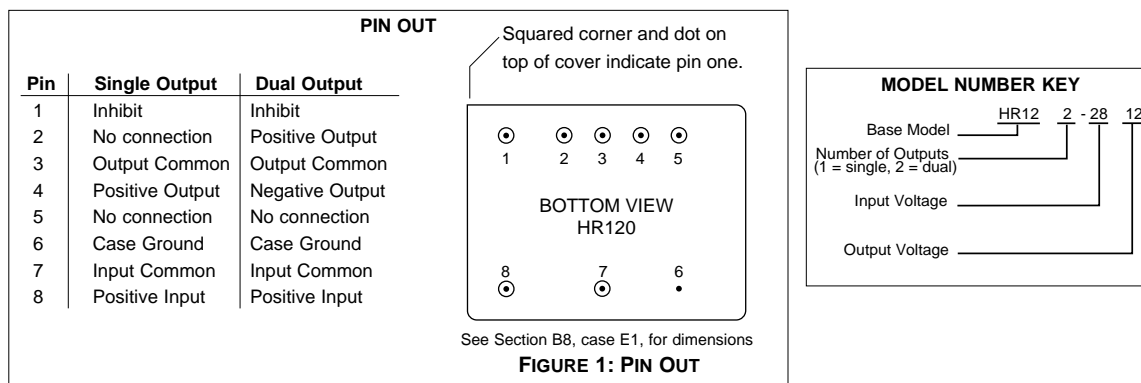

CRANE

interpoint

A CRANE CO. COMPANY

DC/DC CONVERTERS

HR120 SERIES 12 WATT

Typical Performance Curves: 25°C Tc , 28 VDC Vin, 100% load, unless otherwise specified.

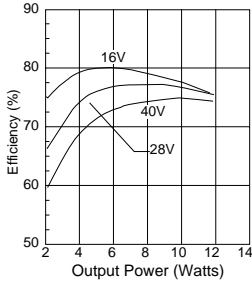

HR121-2805 Efficiency
FIGURE 2

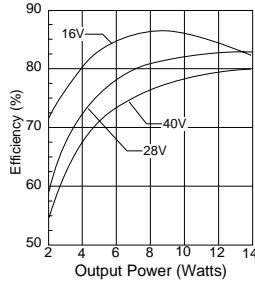

HR121-2812 Efficiency
FIGURE 3

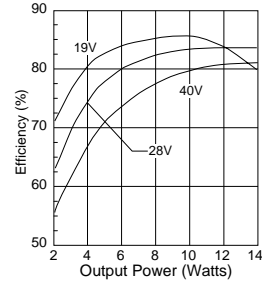

HR121-2815 Efficiency
FIGURE 4

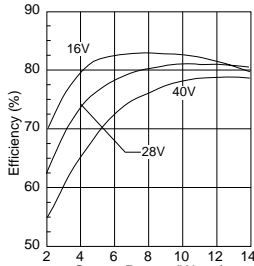

HR122-2812 Efficiency

FIGURE 5

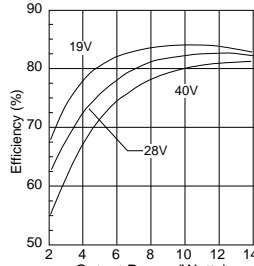

HR122-2815 Efficiency

FIGURE 6

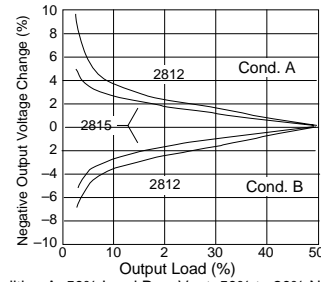

Condition A: 50% Load Pos. Vout, 50% to 20% Neg. Vout
Condition B: 50% Load Neg. Vout, 50% to 20% Pos. Vout
HR122 Negative Output Voltage Cross Regulation

FIGURE 7

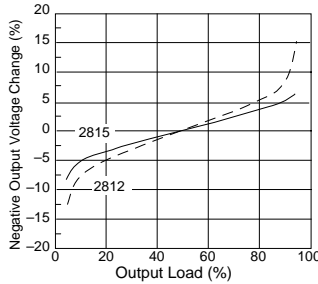

Positive Output 20% to 80% Load
Negative Output 80% to 20% Load
HR122 Negative Output Voltage Cross Regulation

FIGURE 8

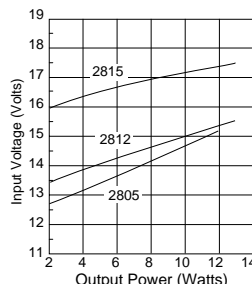

50 mV Drop
HR121 Low Line Dropout

FIGURE 9

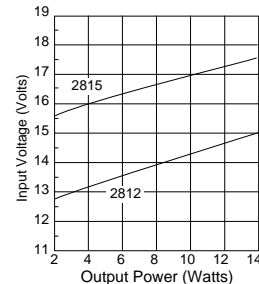

50 mV Drop
HR122 Low Line Dropout

FIGURE 10

CASE E

CASES

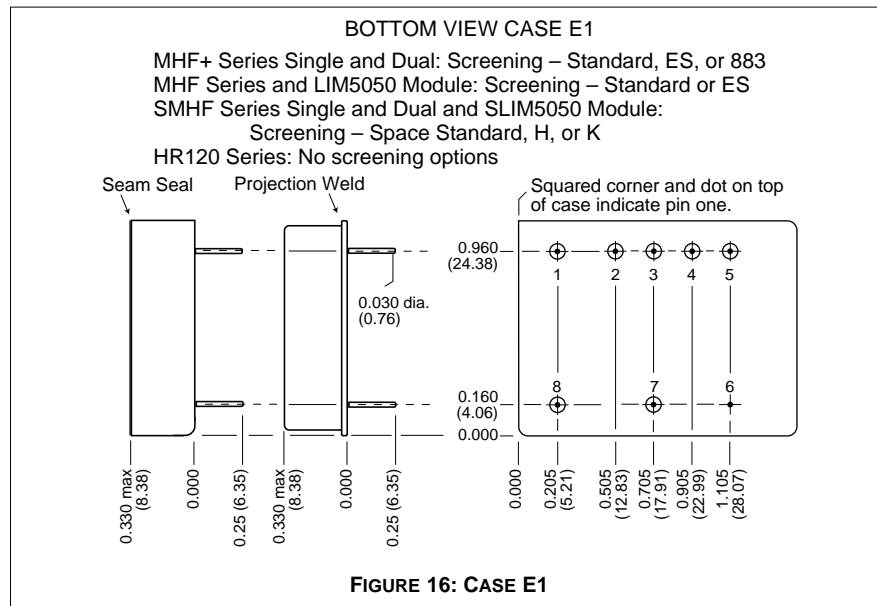
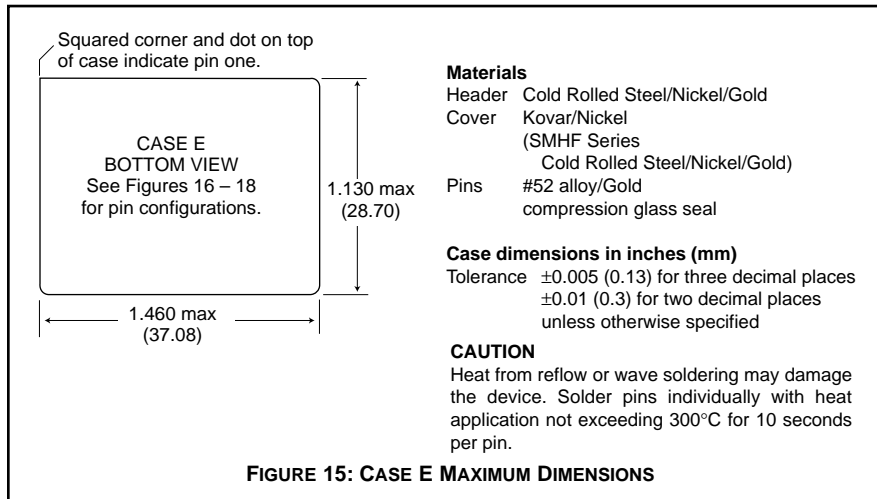

Note: Although every effort has been made to render the case drawings at actual size, variations in the printing process may cause some distortion. Please refer to the numerical dimensions for accuracy.

HR PRODUCTS

TEST (HR products)	STANDARD
PRE-CAP INSPECTION Method 2017	yes
FINAL ELECTRICAL TEST MIL-PRF-38534, Group A Subgroups 1 and 4: +25°C case	yes
HERMETICITY TESTING Gross Leak, Dip (1×10^{-3})	yes
FINAL VISUAL INSPECTION Method 2009	yes

Test methods are referenced to MIL-STD-883 as determined by MIL-PRF-38534.

Applies to the following products:

HR700 Series
HR300 Series
HR150 Series
HR120 Series
HR40 Series