

## FEATURES

- 116dB CMRR Independent of Gain
- Maximum Offset Voltage: 10 $\mu$ V
- Maximum Offset Voltage Drift: 50nV/ $^{\circ}$ C
- Rail-to-Rail Input
- Rail-to-Rail Output
- 2-Resistor Programmable Gain
- Supply Operation: 2.7V to  $\pm$ 5.5V
- Typical Noise: 2.5 $\mu$ V<sub>P-P</sub> (0.01Hz to 10Hz)
- Typical Supply Current: 750 $\mu$ A
- LTC2053-SYNC Allows Synchronization to External Clock
- Available in MS8 and 3mm  $\times$  3mm  $\times$  0.8mm DFN Packages

## APPLICATIONS

- Thermocouple Amplifiers
- Electronic Scales
- Medical Instrumentation
- Strain Gauge Amplifiers
- High Resolution Data Acquisition

## DESCRIPTION

The LTC<sup>®</sup>2053 is a high precision instrumentation amplifier. The CMRR is typically 116dB with a single or dual 5V supply and is independent of gain. The input offset voltage is guaranteed below 10 $\mu$ V with a temperature drift of less than 50nV/ $^{\circ}$ C. The LTC2053 is easy to use; the gain is adjustable with two external resistors, like a traditional op amp.

The LTC2053 uses charge balanced sampled data techniques to convert a differential input voltage into a single ended signal that is in turn amplified by a zero-drift operational amplifier.

The differential inputs operate from rail-to-rail and the single ended output swings from rail-to-rail. The LTC2053 can be used in single supply applications, as low as 2.7V. It can also be used with dual  $\pm$ 5.5V supplies. The LTC2053 requires no external clock, while the LTC2053-SYNC has a CLK pin to synchronize to an external clock.

The LTC2053 is available in an MS8 surface mount package. For space limited applications, the LTC2053 is available in a 3mm  $\times$  3mm  $\times$  0.8mm dual fine pitch leadless package (DFN).

 LTC and LT are registered trademarks of Linear Technology Corporation. All other trademarks are the property of their respective owners.

## TYPICAL APPLICATION

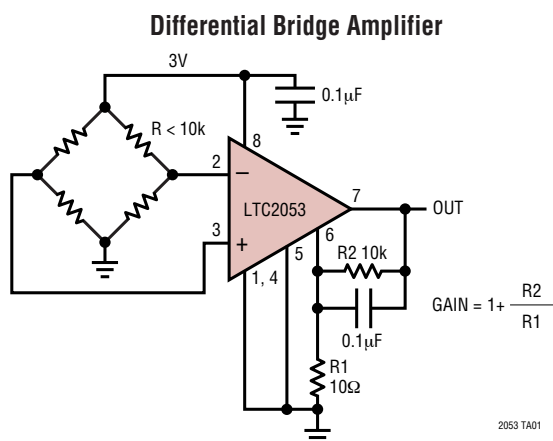

**Typical Input Referred Offset vs Input Common Mode Voltage ( $V_S = 3V$ )**

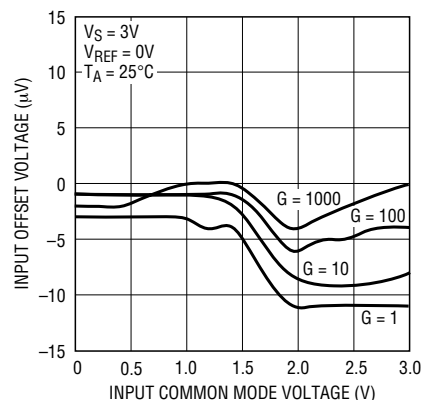

2053syncfb

# LTC2053/LTC2053-SYNC

## ABSOLUTE MAXIMUM RATINGS

(Note 1)

Total Supply Voltage ( $V^+$ to $V^-$ ) .....	11V	LTC2053I, LTC2053I-SYNC .....	-40°C to 85°C
Input Current .....	$\pm 10\text{mA}$	LTC2053H .....	-40°C to 125°C
$ V_{IN}^+ - V_{REF} $ .....	5.5V	Storage Temperature Range	
$ V_{IN}^- - V_{REF} $ .....	5.5V	MS8 Package .....	-65°C to 150°C
Output Short Circuit Duration .....	Indefinite	DD Package .....	-65°C to 125°C
Operating Temperature Range		Lead Temperature (Soldering, 10 sec) .....	300°C
LTC2053C, LTC2053C-SYNC .....	0°C to 70°C		

## PACKAGE/ORDER INFORMATION

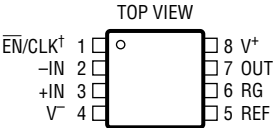
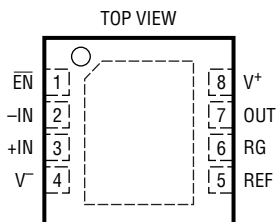
 <p>MS8 PACKAGE 8-LEAD PLASTIC MSOP</p> <p><math>T_{JMAX} = 150^\circ\text{C}</math>, <math>\theta_{JA} = 200^\circ\text{C/W}</math></p> <p><sup>†</sup>PIN 1 IS <math>\overline{\text{EN}}</math> ON LTC2053, CLK ON LTC2053-SYNC</p>	ORDER PART NUMBER	 <p>DD PACKAGE 8-LEAD (3mm x 3mm) PLASTIC DFN</p> <p><math>T_{JMAX} = 125^\circ\text{C}</math>, <math>\theta_{JA} = 160^\circ\text{C/W}</math></p> <p>UNDERSIDE METAL INTERNALLY CONNECTED TO <math>V^-</math> (PCB CONNECTION OPTIONAL)</p>	ORDER PART NUMBER
	LTC2053CMS8 LTC2053IMS8 LTC2053HMS8		LTC2053CDD LTC2053IDD LTC2053HDD
	LTC2053CMS8-SYNC LTC2053IMS8-SYNC		DD PART MARKING
	MS8 PART MARKING		*LAEQ
	LTVT LTJY LTAFB		
*LTBNP			

\*The temperature grade (C, I, or H) is indicated on the shipping container. Consult LTC Marketing for parts specified with wider operating temperature ranges.

## ELECTRICAL CHARACTERISTICS

The ● denotes the specifications which apply over the full operating temperature range, otherwise specifications are at  $T_A = 25^\circ\text{C}$ .  $V^+ = 3\text{V}$ ,  $V^- = 0\text{V}$ ,  $\text{REF} = 200\text{mV}$ . Output voltage swing is referenced to  $V^-$ . All other specifications reference the OUT pin to the REF pin.

PARAMETER	CONDITIONS		MIN	TYP	MAX	UNITS
Gain Error	$A_V = 1$	●		0.001	0.01	%
Gain Nonlinearity	$A_V = 1$ , LTC2053	●		3	12	ppm
	$A_V = 1$ , LTC2053-SYNC	●		3	15	ppm
Input Offset Voltage (Note 2)	$V_{CM} = 200\text{mV}$			-5	$\pm 10$	$\mu\text{V}$
Average Input Offset Drift (Note 2)	$T_A = -40^\circ\text{C}$ to $85^\circ\text{C}$	●			$\pm 50$	$\text{nV}/^\circ\text{C}$
	$T_A = 85^\circ\text{C}$ to $125^\circ\text{C}$	●		-1	-2.5	$\mu\text{V}/^\circ\text{C}$
Average Input Bias Current (Note 3)	$V_{CM} = 1.2\text{V}$	●		4	10	nA
Average Input Offset Current (Note 3)	$V_{CM} = 1.2\text{V}$	●		1	3	nA
Input Noise Voltage	DC to 10Hz			2.5		$\mu\text{V}_{P-P}$
Common Mode Rejection Ratio (Notes 4, 5)	$A_V = 1$ , $V_{CM} = 0\text{V}$ to $3\text{V}$ , LTC2053C, LTC2053C-SYNC	●	100	113		dB
	$A_V = 1$ , $V_{CM} = 0.1\text{V}$ to $2.9\text{V}$ , LTC2053I, LTC2053I-SYNC	●	100	113		dB
	$A_V = 1$ , $V_{CM} = 0\text{V}$ to $3\text{V}$ , LTC2053I, LTC2053I-SYNC	●	95	113		dB
	$A_V = 1$ , $V_{CM} = 0.1\text{V}$ to $2.9\text{V}$ , LTC2053H	●	100			dB
	$A_V = 1$ , $V_{CM} = 0\text{V}$ to $3\text{V}$ , LTC2053H	●	85			dB

2053syncfb

**ELECTRICAL CHARACTERISTICS** The ● denotes the specifications which apply over the full operating temperature range, otherwise specifications are at  $T_A = 25^\circ\text{C}$ .  $V^+ = 3\text{V}$ ,  $V^- = 0\text{V}$ ,  $\text{REF} = 200\text{mV}$ . Output voltage swing is referenced to  $V^-$ . All other specifications reference the OUT pin to the REF pin.

PARAMETER	CONDITIONS		MIN	TYP	MAX	UNITS
Power Supply Rejection Ratio (Note 6)	$V_S = 2.7\text{V to } 6\text{V}$	●	110	116		dB
Output Voltage Swing High	$R_L = 2\text{k to } V^-$ $R_L = 10\text{k to } V^-$	●	2.85	2.94		V
		●	2.95	2.98		V
Output Voltage Swing Low		●			20	mV
Supply Current	No Load	●		0.75	1	mA
Supply Current, Shutdown	$V_{\overline{\text{EN}}} \geq 2.5\text{V}$ , LTC2053 Only				10	$\mu\text{A}$
$\overline{\text{EN}}/\text{CLK}$ Pin Input Low Voltage, $V_{\text{IL}}$					0.5	V
$\overline{\text{EN}}/\text{CLK}$ Pin Input High Voltage, $V_{\text{IH}}$			2.5			V
$\overline{\text{EN}}/\text{CLK}$ Pin Input Current	$V_{\overline{\text{EN}}/\text{CLK}} = V^-$			-0.5	-10	$\mu\text{A}$
Internal Op Amp Gain Bandwidth				200		kHz
Slew Rate				0.2		$\text{V}/\mu\text{s}$
Internal Sampling Frequency				3		kHz

The ● denotes the specifications which apply over the full operating temperature range, otherwise specifications are at  $T_A = 25^\circ\text{C}$ .  $V^+ = 5\text{V}$ ,  $V^- = 0\text{V}$ ,  $\text{REF} = 200\text{mV}$ . Output voltage swing is referenced to  $V^-$ . All other specifications reference the OUT pin to the REF pin.

PARAMETER	CONDITIONS		MIN	TYP	MAX	UNITS
Gain Error	$A_V = 1$	●		0.001	0.01	%
Gain Nonlinearity	$A_V = 1$	●		3	10	ppm
Input Offset Voltage (Note 2)	$V_{\text{CM}} = 200\text{mV}$			-5	$\pm 10$	$\mu\text{V}$
Average Input Offset Drift (Note 2)	$T_A = -40^\circ\text{C to } 85^\circ\text{C}$ $T_A = 85^\circ\text{C to } 125^\circ\text{C}$	●			$\pm 50$	$\text{nV}/^\circ\text{C}$
		●		-1	-2.5	$\mu\text{V}/^\circ\text{C}$
Average Input Bias Current (Note 3)	$V_{\text{CM}} = 1.2\text{V}$	●		4	10	nA
Average Input Offset Current (Note 3)	$V_{\text{CM}} = 1.2\text{V}$	●		1	3	nA
Common Mode Rejection Ratio (Notes 4, 5)	$A_V = 1$ , $V_{\text{CM}} = 0\text{V to } 5\text{V}$ , LTC2053C	●	105	116		dB
	$A_V = 1$ , $V_{\text{CM}} = 0\text{V to } 5\text{V}$ , LTC2053C-SYNC	●	100	116		dB
	$A_V = 1$ , $V_{\text{CM}} = 0.1\text{V to } 4.9\text{V}$ , LTC2053I	●	105	116		dB
	$A_V = 1$ , $V_{\text{CM}} = 0.1\text{V to } 4.9\text{V}$ , LTC2053I-SYNC	●	100	116		dB
	$A_V = 1$ , $V_{\text{CM}} = 0\text{V to } 5\text{V}$ , LTC2053I, LTC2053I-SYNC	●	95	116		dB
	$A_V = 1$ , $V_{\text{CM}} = 0.1\text{V to } 4.9\text{V}$ , LTC2053H	●	100			dB
$A_V = 1$ , $V_{\text{CM}} = 0\text{V to } 5\text{V}$ , LTC2053H	●	85			dB	
Power Supply Rejection Ratio (Note 6)	$V_S = 2.7\text{V to } 6\text{V}$	●	110	116		dB
Output Voltage Swing High	$R_L = 2\text{k to } V^-$ $R_L = 10\text{k to } V^-$	●	4.85	4.94		V
		●	4.95	4.98		V
Output Voltage Swing Low		●			20	mV
Supply Current	No Load	●		0.85	1.1	mA
Supply Current, Shutdown	$V_{\overline{\text{EN}}} \geq 4.5\text{V}$ , LTC2053 Only				10	$\mu\text{A}$
$\overline{\text{EN}}/\text{CLK}$ Pin Input Low Voltage, $V_{\text{IL}}$					0.5	V
$\overline{\text{EN}}/\text{CLK}$ Pin Input High Voltage, $V_{\text{IH}}$			4.5			V
$\overline{\text{EN}}/\text{CLK}$ Pin Input Current	$V_{\overline{\text{EN}}/\text{CLK}} = V^-$			-1	-10	$\mu\text{A}$
Internal Op Amp Gain Bandwidth				200		kHz
Slew Rate				0.2		$\text{V}/\mu\text{s}$
Internal Sampling Frequency				3		kHz

# LTC2053/LTC2053-SYNC

## ELECTRICAL CHARACTERISTICS

The ● denotes the specifications which apply over the full operating temperature range, otherwise specifications are at  $T_A = 25^\circ\text{C}$ .  $V^+ = 5\text{V}$ ,  $V^- = -5\text{V}$ ,  $\text{REF} = 0\text{V}$ .

PARAMETER	CONDITIONS		MIN	TYP	MAX	UNITS
Gain Error	$A_V = 1$	●		0.001	0.01	%
Gain Nonlinearity	$A_V = 1$	●		3	10	ppm
Input Offset Voltage (Note 2)	$V_{\text{CM}} = 0\text{V}$			10	$\pm 20$	$\mu\text{V}$
Average Input Offset Drift (Note 2)	$T_A = -40^\circ\text{C}$ to $85^\circ\text{C}$	●			$\pm 50$	$\text{nV}/^\circ\text{C}$
	$T_A = 85^\circ\text{C}$ to $125^\circ\text{C}$	●		-1	-2.5	$\mu\text{V}/^\circ\text{C}$
Average Input Bias Current (Note 3)	$V_{\text{CM}} = 1\text{V}$	●		4	10	nA
Average Input Offset Current (Note 3)	$V_{\text{CM}} = 1\text{V}$	●		1	3	nA
Common Mode Rejection Ratio (Notes 4, 5)	$A_V = 1$ , $V_{\text{CM}} = -5\text{V}$ to $5\text{V}$ , LTC2053C	●	105	118		dB
	$A_V = 1$ , $V_{\text{CM}} = -5\text{V}$ to $5\text{V}$ , LTC2053C-SYNC	●	100	118		dB
	$A_V = 1$ , $V_{\text{CM}} = -4.9\text{V}$ to $4.9\text{V}$ , LTC2053I	●	105	118		dB
	$A_V = 1$ , $V_{\text{CM}} = -4.9\text{V}$ to $4.9\text{V}$ , LTC2053I-SYNC	●	100	118		dB
	$A_V = 1$ , $V_{\text{CM}} = -5\text{V}$ to $5\text{V}$ , LTC2053I, LTC2053I-SYNC	●	95	118		dB
	$A_V = 1$ , $V_{\text{CM}} = -4.9\text{V}$ to $4.9\text{V}$ , LTC2053H	●	100			dB
	$A_V = 1$ , $V_{\text{CM}} = -5\text{V}$ to $5\text{V}$ , LTC2053H	●	90			dB
Power Supply Rejection Ratio (Note 6)	$V_S = 2.7\text{V}$ to $11\text{V}$	●	110	116		dB
Maximum Output Voltage Swing	$R_L = 2\text{k}$ to GND, C and I Grades	●	$\pm 4.5$	$\pm 4.8$		V
	$R_L = 10\text{k}$ to GND, All Grades	●	$\pm 4.6$	$\pm 4.9$		V
	$R_L = 2\text{k}$ to GND, LTC2053H Only	●	$\pm 4.4$	$\pm 4.8$		V
Supply Current	No Load	●		0.95	1.3	mA
Supply Current, Shutdown	$V_{\text{EN}} \geq 4.5\text{V}$ , LTC2053 Only				20	$\mu\text{A}$
EN Pin Input Low Voltage, $V_{\text{IL}}$					-4.5	V
CLK Pin Input Low Voltage, $V_{\text{IL}}$					0.5	V
EN/CLK Pin Input High Voltage, $V_{\text{IH}}$			4.5			V
EN/CLK Pin Input Current	$V_{\text{EN/CLK}} = V^-$			-3	-20	$\mu\text{A}$
Internal Op Amp Gain Bandwidth				200		kHz
Slew Rate				0.2		$\text{V}/\mu\text{s}$
Internal Sampling Frequency				3		kHz

**Note 1:** Absolute Maximum Ratings are those values beyond which the life of a device may be impaired.

**Note 2:** These parameters are guaranteed by design. Thermocouple effects preclude measurement of these voltage levels in high speed automatic test systems.  $V_{\text{OS}}$  is measured to a limit determined by test equipment capability.

**Note 3:** If the total source resistance is less than  $10\text{k}$ , no DC errors result from the input bias currents or the mismatch of the input bias currents or the mismatch of the resistances connected to  $-IN$  and  $+IN$ .

**Note 4:** The CMRR with a voltage gain,  $A_V$ , larger than 10 is 120dB (typ).

**Note 5:** At temperatures above  $70^\circ\text{C}$ , the common mode rejection ratio lowers when the common mode input voltage is within  $100\text{mV}$  of the supply rails.

**Note 6:** The power supply rejection ratio (PSRR) measurement accuracy depends on the proximity of the power supply bypass capacitor to the device under test. Because of this, the PSRR is 100% tested to relaxed limits at final test. However, their values are guaranteed by design to meet the data sheet limits.

# TYPICAL PERFORMANCE CHARACTERISTICS

**Input Offset Voltage vs Input Common Mode Voltage**

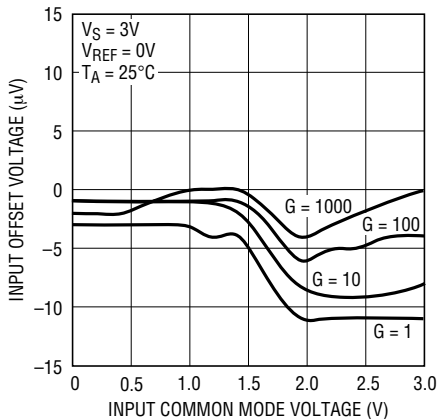

2053 G01

**Input Offset Voltage vs Input Common Mode Voltage**

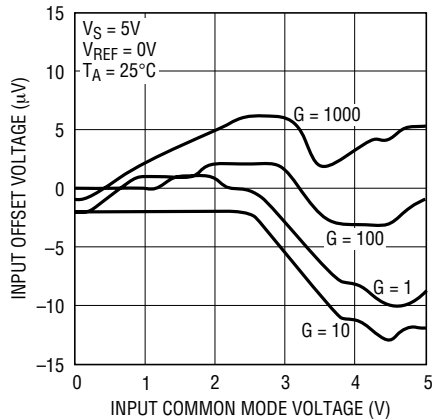

2053 G02

**Input Offset Voltage vs Input Common Mode Voltage**

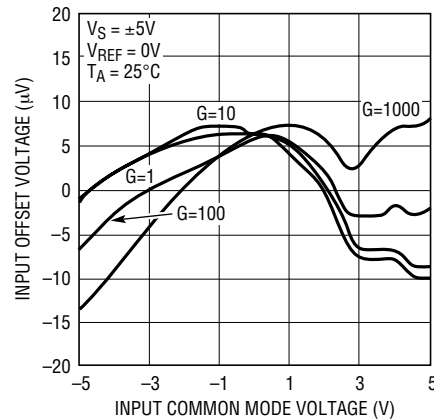

2053 G03

**Input Offset Voltage vs Input Common Mode Voltage**

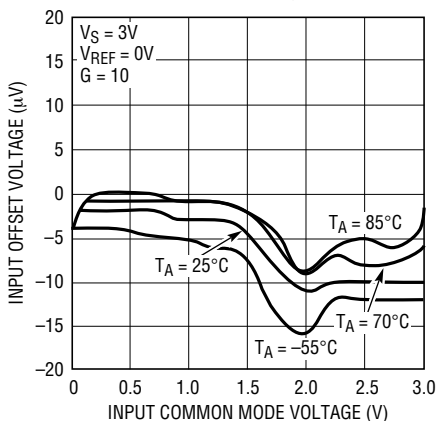

2053 G04

**Input Offset Voltage vs Input Common Mode Voltage**

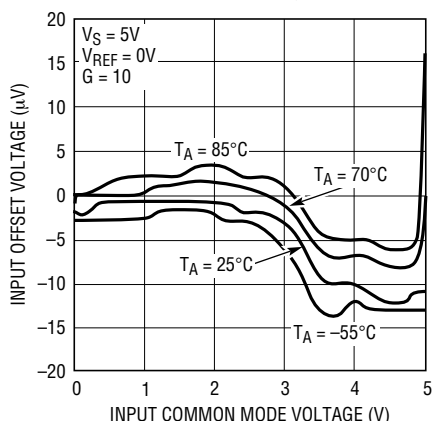

2053 G05

**Input Offset Voltage vs Input Common Mode Voltage**

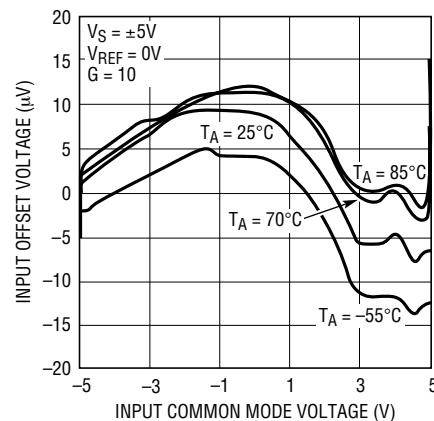

2053 G06

**Input Offset Voltage vs Input Common Mode Voltage**

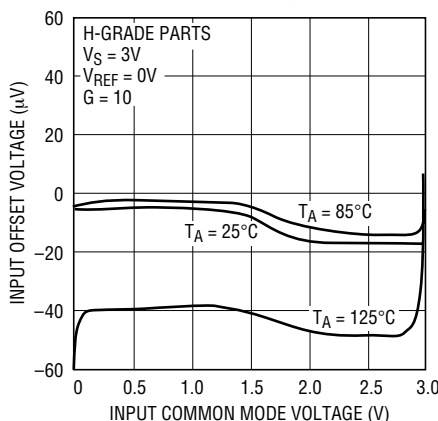

2053 G07

**Input Offset Voltage vs Input Common Mode Voltage**

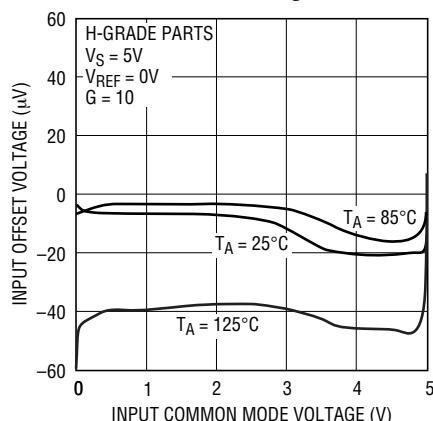

2053 G08

**Input Offset Voltage vs Input Common Mode Voltage**

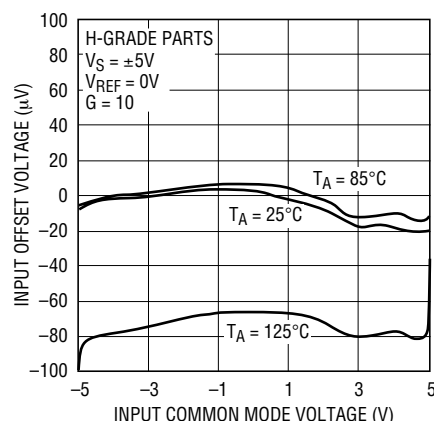

2053 G09

2053syncfb

# TYPICAL PERFORMANCE CHARACTERISTICS

**Error Due to Input  $R_S$  vs Input Common Mode ( $C_{IN} < 100pF$ )**

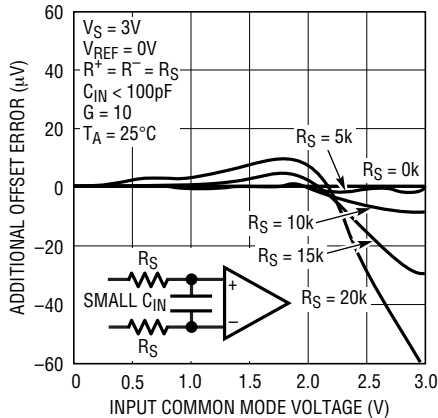

**Error Due to Input  $R_S$  vs Input Common Mode ( $C_{IN} < 100pF$ )**

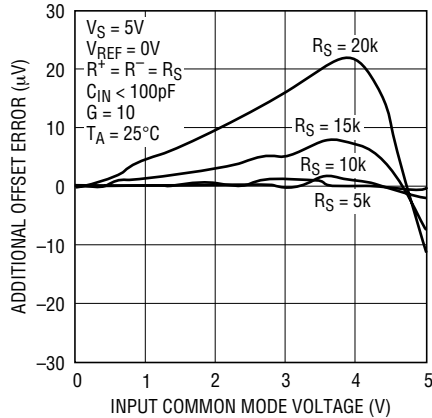

**Error Due to Input  $R_S$  vs Input Common Mode ( $C_{IN} < 100pF$ )**

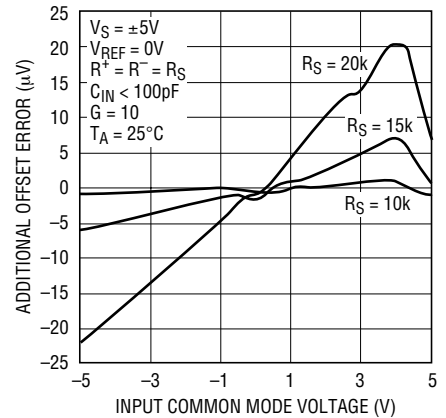

**Error Due to Input  $R_S$  Mismatch vs Input Common Mode ( $C_{IN} < 100pF$ )**

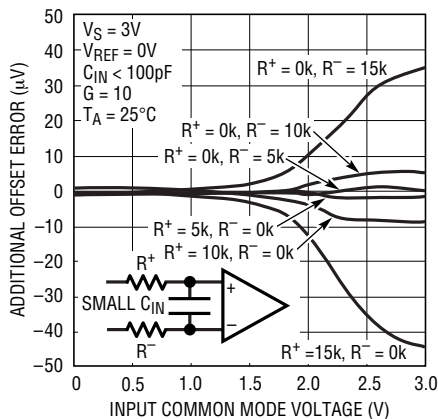

**Error Due to Input  $R_S$  Mismatch vs Input Common Mode ( $C_{IN} < 100pF$ )**

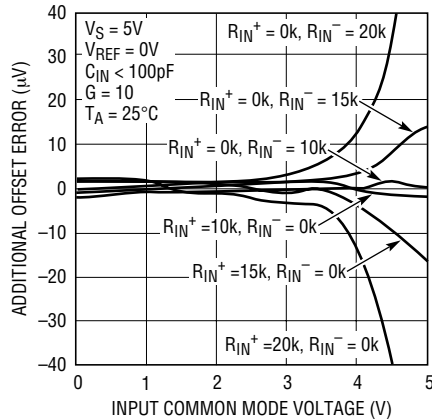

**Error Due to Input  $R_S$  Mismatch vs Input Common Mode ( $C_{IN} < 100pF$ )**

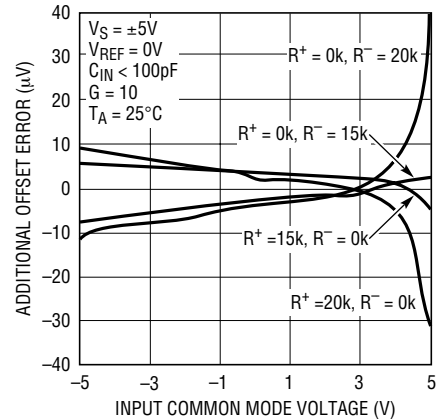

**Error Due to Input  $R_S$  vs Input Common Mode ( $C_{IN} > 1\mu F$ )**

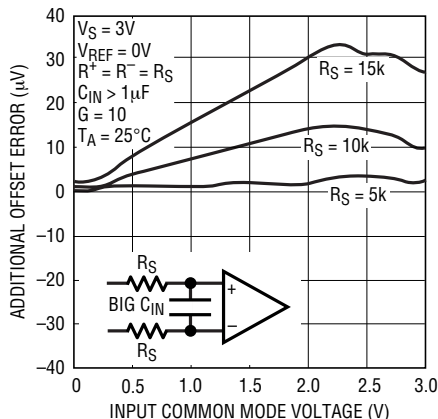

**Error Due to Input  $R_S$  vs Input Common Mode ( $C_{IN} > 1\mu F$ )**

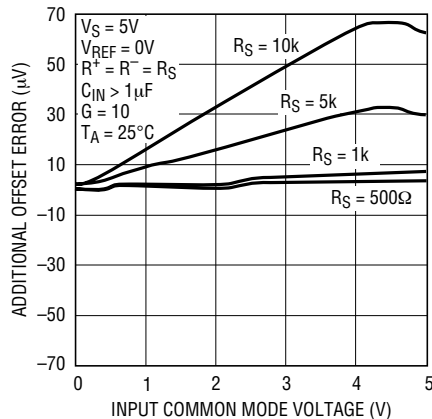

**Error Due to Input  $R_S$  vs Input Common Mode ( $C_{IN} > 1\mu F$ )**

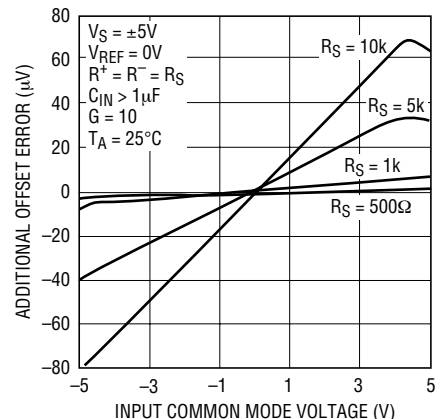

# TYPICAL PERFORMANCE CHARACTERISTICS

**Error Due to Input  $R_S$  Mismatch vs Input Common Mode ( $C_{IN} > 1\mu F$ )**

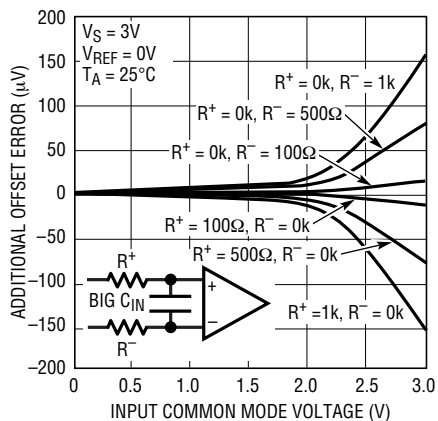

**Error Due to Input  $R_S$  Mismatch vs Input Common Mode ( $C_{IN} > 1\mu F$ )**

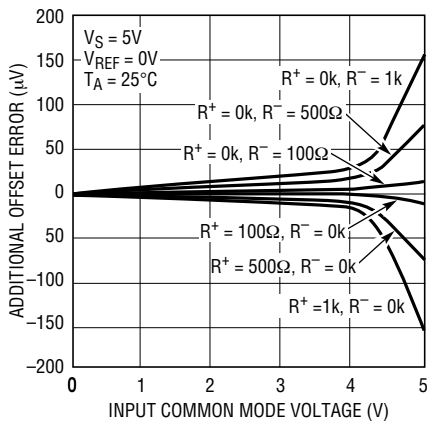

**Error Due to Input  $R_S$  Mismatch vs Input Common Mode ( $C_{IN} > 1\mu F$ )**

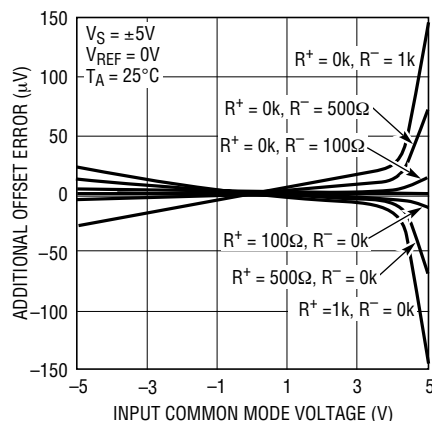

**Offset Voltage vs Temperature**

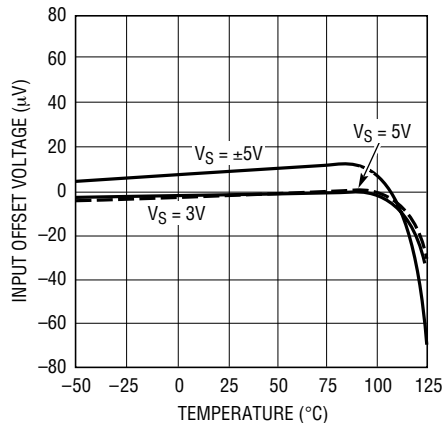

**$V_{OS}$  vs REF (Pin 5)**

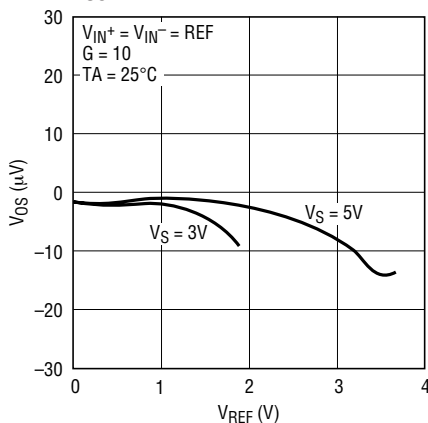

**$V_{OS}$  vs REF (Pin 5)**

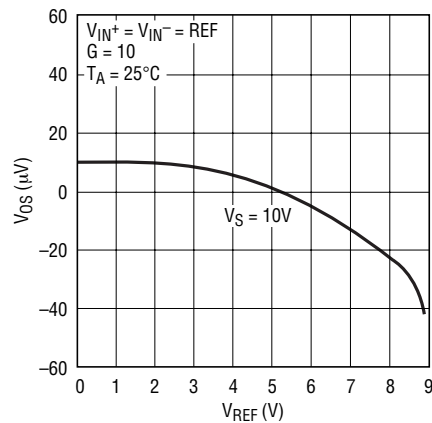

**Gain Nonlinearity, G = 1**

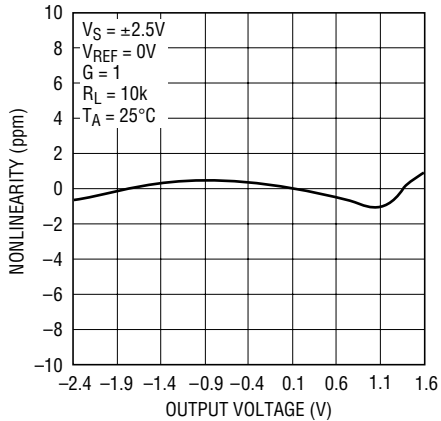

**Gain Nonlinearity, G = 10**

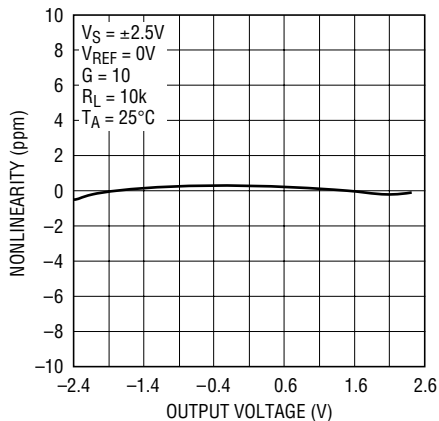

**CMRR vs Frequency**

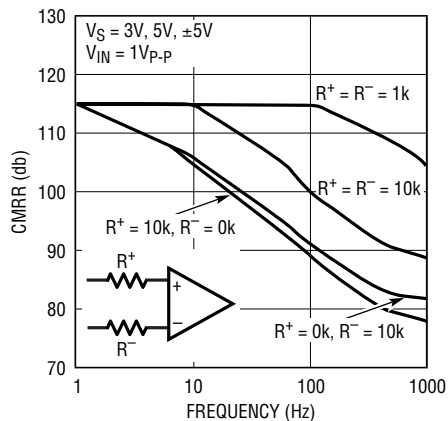

## TYPICAL PERFORMANCE CHARACTERISTICS

**Input Voltage Noise Density vs Frequency**

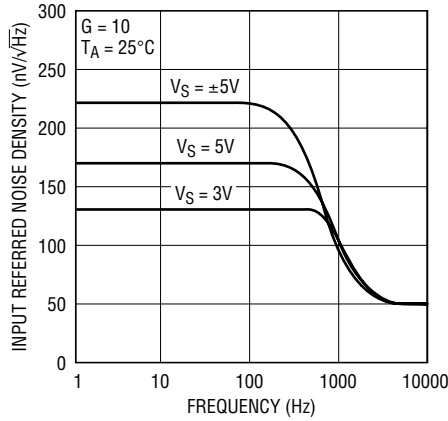

2053 G28

**Input Referred Noise in 10Hz Bandwidth**

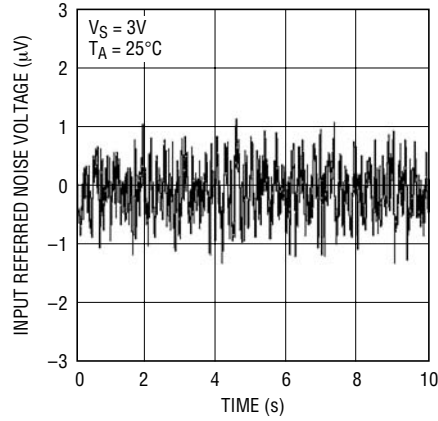

2053 G29

**Input Referred Noise in 10Hz Bandwidth**

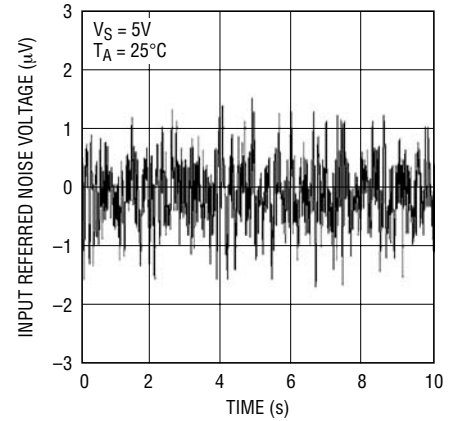

2053 G30

**Output Voltage Swing vs Output Current**

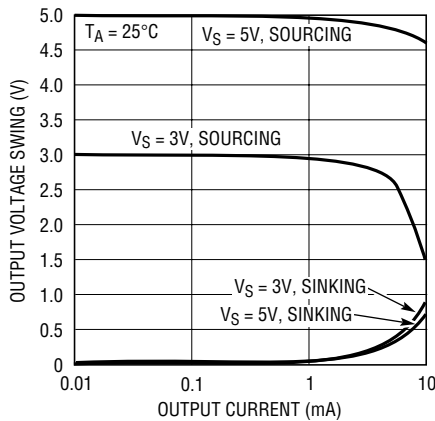

2053 G31

**Output Voltage Swing vs Output Current**

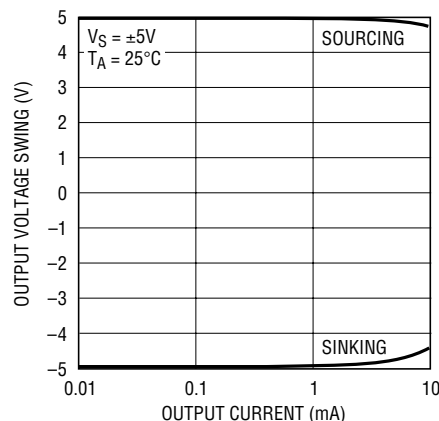

2053 G32

**Supply Current vs Supply Voltage**

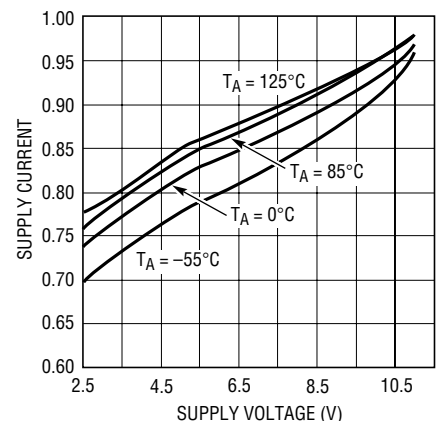

2053 G33

**Low Gain Settling Time vs Settling Accuracy**

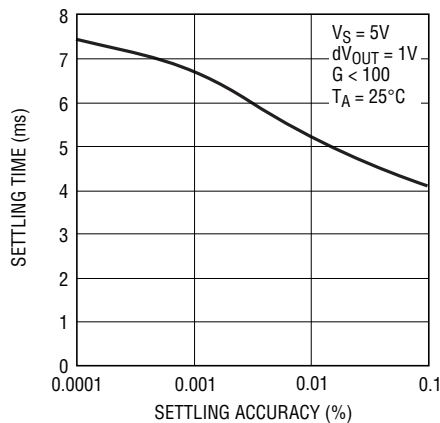

2053 G34

**Settling Time vs Gain**

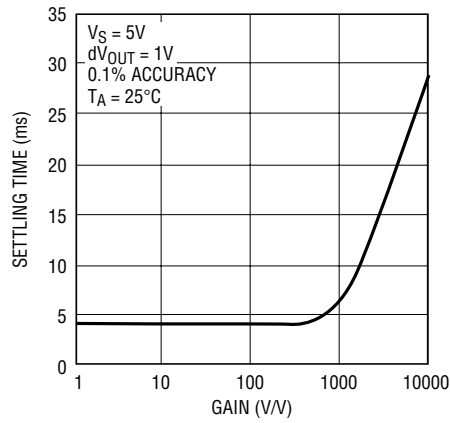

2053 G35

**Internal Clock Frequency vs Supply Voltage**

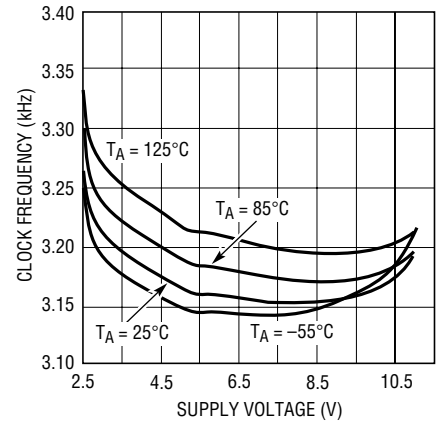

2053 G36



## PIN FUNCTIONS

**$\overline{\text{EN}}$  (Pin 1, LTC2053 Only):** Active Low Enable Pin.

**CLK (Pin 1, LTC2053-SYNC Only):** Clock input for synchronizing to external system clock.

**-IN (Pin 2):** Inverting Input.

**+IN (Pin 3):** Noninverting Input.

**$V^-$  (Pin 4):** Negative Supply.

**REF (Pin 5):** Voltage Reference ( $V_{\text{REF}}$ ) for Amplifier Output.

**RG (Pin 6):** Inverting Input of Internal Op Amp. With a resistor, R2, connected between the OUT pin and the RG pin and a resistor, R1, between the RG pin and the REF pin, the DC gain is given by  $1 + R2 / R1$ .

**OUT (Pin 7):** Amplifier Output.

$$V_{\text{OUT}} = \text{GAIN} (V_{+\text{IN}} - V_{-\text{IN}}) + V_{\text{REF}}$$

**$V^+$  (Pin 8):** Positive Supply.

## BLOCK DIAGRAM

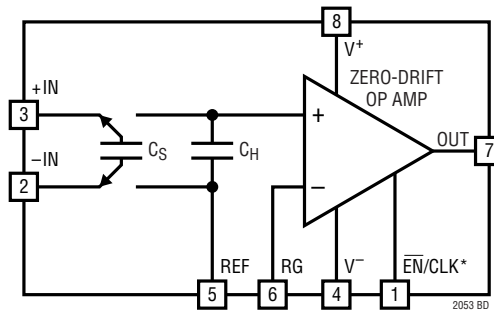

\*NOTE: PIN 1 IS  $\overline{\text{EN}}$  ON THE LTC2053 AND CLK ON THE LTC2053-SYNC.

## APPLICATIONS INFORMATION

### Theory of Operation

The LTC2053 uses an internal capacitor ( $C_S$ ) to sample a differential input signal riding on a DC common mode voltage (see Block Diagram). This capacitor's charge is transferred to a second internal hold capacitor ( $C_H$ ) translating the common mode of the input differential signal to that of the REF pin. The resulting signal is amplified by a zero-drift op amp in the noninverting configuration. The RG pin is the negative input of this op amp and allows external programmability of the DC gain. Simple filtering can be realized by using an external capacitor across the feedback resistor.

### Input Voltage Range

The input common mode voltage range of the LTC2053 is rail-to-rail. However, the following equation limits the size of the differential input voltage:

$$V^- \leq (V_{+\text{IN}} - V_{-\text{IN}}) + V_{\text{REF}} \leq V^+ - 1.3$$

Where  $V_{+\text{IN}}$  and  $V_{-\text{IN}}$  are the voltages of the +IN and -IN pins respectively,  $V_{\text{REF}}$  is the voltage at the REF pin and  $V^+$  is the positive supply voltage.

For example, with a 3V single supply and a 0V to 100mV differential input voltage,  $V_{\text{REF}}$  must be between 0V and 1.6V.

### $\pm 5$ Volt Operation

When using the LTC2053 with supplies over 5.5V, care must be taken to limit the maximum difference between any of the input pins (+IN or -IN) and the REF pin to 5.5V; if not, the device will be damaged. For example, if rail-to-rail input operation is desired when the supplies are at  $\pm 5$ V, the REF pin should be 0V,  $\pm 0.5$ V. As a second example, if  $V^+$  is 10V and  $V^-$  and REF are at 0V, the inputs should not exceed 5.5V.

## APPLICATIONS INFORMATION

### Settling Time

The sampling rate is 3kHz and the input sampling period during which  $C_S$  is charged to the input differential voltage  $V_{IN}$  is approximately  $150\mu s$ . First assume that on each input sampling period,  $C_S$  is charged fully to  $V_{IN}$ . Since  $C_S = C_H (= 1000pF)$ , a change in the input will settle to N bits of accuracy at the op amp noninverting input after N clock cycles or  $333\mu s(N)$ . The settling time at the OUT pin is also affected by the settling of the internal op amp. Since the gain bandwidth of the internal op amp is typically 200kHz, the settling time is dominated by the switched capacitor front end for gains below 100 (see Typical Performance Characteristics).

### Input Current

Whenever the differential input  $V_{IN}$  changes,  $C_H$  must be charged up to the new input voltage via  $C_S$ . This results in an input charging current during each input sampling period. Eventually,  $C_H$  and  $C_S$  will reach  $V_{IN}$  and, ideally, the input current would go to zero for DC inputs.

In reality, there are additional parasitic capacitors which disturb the charge on  $C_S$  every cycle even if  $V_{IN}$  is a DC voltage. For example, the parasitic bottom plate capacitor on  $C_S$  must be charged from the voltage on the REF pin to the voltage on the  $-IN$  pin every cycle. The resulting input

charging current decays exponentially during each input sampling period with a time constant equal to  $R_S C_S$ . **If the voltage disturbance due to these currents settles before the end of the sampling period, there will be no errors due to source resistance or the source resistance mismatch between  $-IN$  and  $+IN$ . With  $R_S$  less than 10k, no DC errors occur due to this input current.**

In the Typical Performance Characteristics section of this data sheet, there are curves showing the additional error from non-zero source resistance in the inputs. If there are no large capacitors across the inputs, the amplifier is less sensitive to source resistance and source resistance mismatch. When large capacitors are placed across the inputs, the input charging currents described above result in larger DC errors, especially with source resistor mismatches.

### Power Supply Bypassing

The LTC2053 uses a sampled data technique and therefore contains some clocked digital circuitry. It is therefore sensitive to supply bypassing. For single or dual supply operation, a  $0.1\mu F$  ceramic capacitor must be connected between Pin 8 ( $V^+$ ) and Pin 4 ( $V^-$ ) with leads as short as possible.

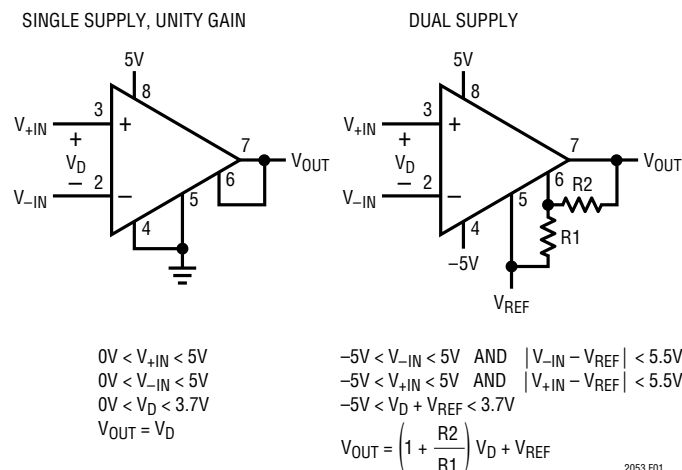

Figure 1

## APPLICATIONS INFORMATION

### Synchronizing to an External Clock (LTC2053-SYNC Only)

The LTC2053 has an internally generated sample clock that is typically 3kHz. **There is no need to provide the LTC2053 with a clock.** However, in some applications, it may be desirable for the user to control the sampling frequency more precisely to avoid undesirable aliasing. This can be done with the LTC2053-SYNC. This device uses PIN 1 as a clock input whereas the LTC2053 uses Pin 1 as an enable pin. If CLK (PIN 1) is left floating on the LTC2053-SYNC, the device will run on its internal oscillator, similar to the LTC2053. However, if not externally synchronizing to a system clock, it is recommended that the LTC2053 be used instead of the LTC2053-SYNC because the LTC2053-SYNC is sensitive to parasitic capacitance on the CLK pin when left floating. **Clocking the LTC2053-SYNC is accomplished by driving the CLK pin at 8 times the desired sample clock frequency. This completely disables the internal clock. For example, to achieve the nominal LTC2053 sample clock rate of 3kHz, a 24kHz external clock should be applied to the CLK pin of the LTC2053-SYNC.** If a square wave is used to drive the CLK pin, a 5 $\mu$ s RC time constant should be placed in front of the CLK pin to maintain low offset voltage performance (see Figure 2). This avoids internal and external coupling of the high frequency components of the external clock at the instant the LTC2053-SYNC holds the sampled input.

The LTC2053-SYNC is tested with a sample clock of 3kHz ( $f_{CLK} = 24kHz$ ) to the same specifications as the LTC2053. In addition the LTC2053-SYNC is tested at 1/2 and 2X this frequency to verify proper operation. The curves in the Typical Performance Characteristics section of this datasheet apply to the LTC2053-SYNC when driving it with a 24kHz clock at PIN 1 ( $f_{CLK} = 24kHz$ , 3kHz sample clock rate). Below are three curves that show the behavior of the LTC2053-SYNC as the clock frequency is varied. The offset is essentially unaffected over a 2:1 increase or decrease of the typical LTC2053 sample clock speed. The bias current is directly proportional to the clock speed. The noise is roughly proportional to the square root of the clock frequency. **For optimum noise and bias current performance, drive the LTC2053-SYNC with a nominal 24kHz external clock (3kHz sample clock).**

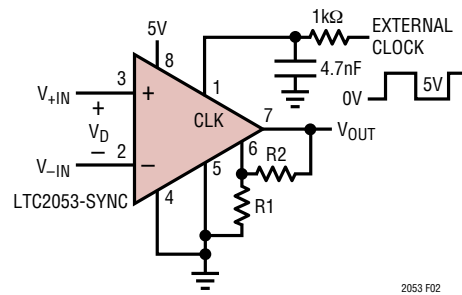
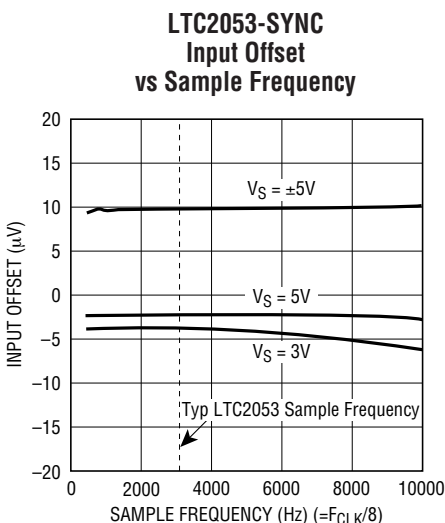
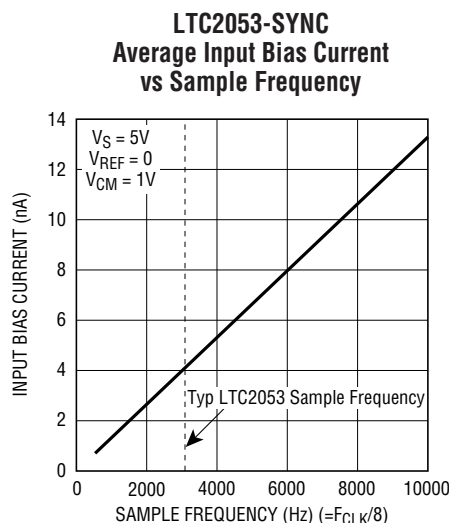

Figure 2



2053 F03



2053 F04

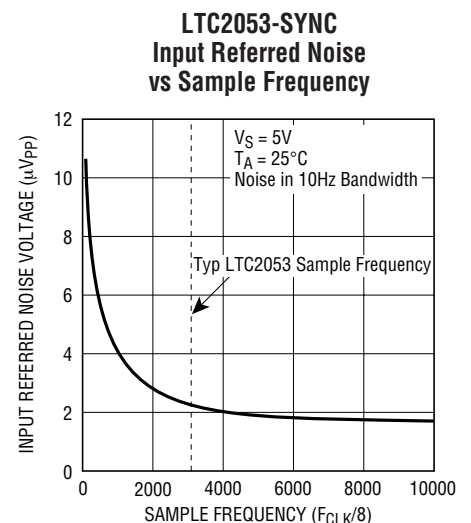

2053 F05

2053syncfb

## TYPICAL APPLICATIONS

**Precision Current Source**

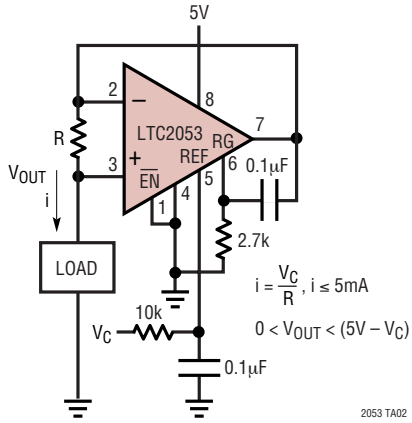

**Precision  $\pm 2$   
(Low Noise 2.5V Reference)**

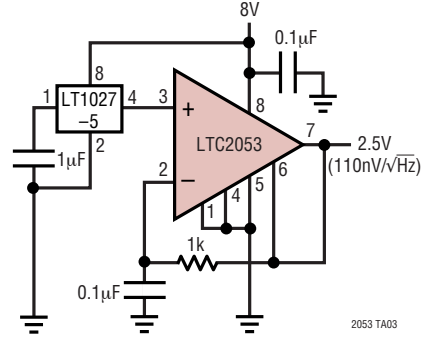

**Precision Doubler  
(General Purpose)**

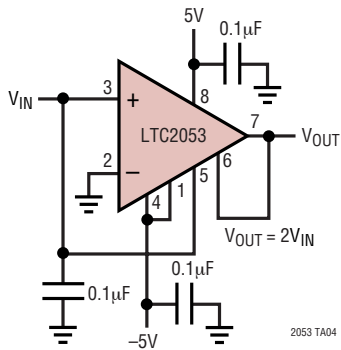

**Precision Inversion  
(General Purpose)**

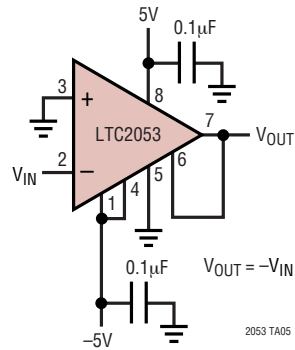

# TYPICAL APPLICATIONS

Differential Thermocouple Amplifier

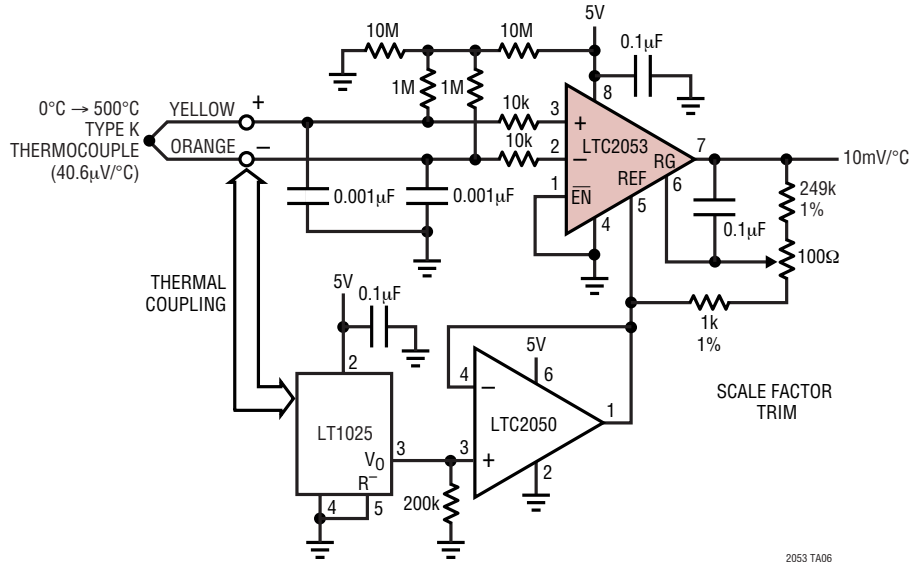

High Side Power Supply Current Sense

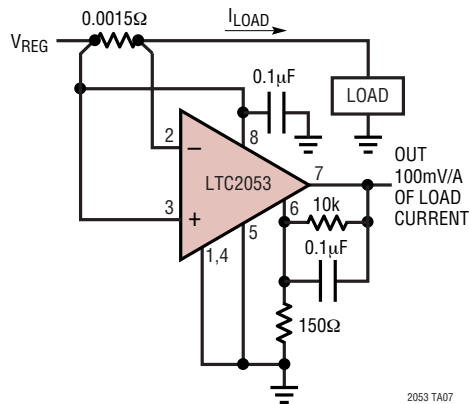

## PACKAGE DESCRIPTION

**MS8 Package**  
**8-Lead Plastic MSOP**  
 (Reference LTC DWG # 05-08-1660)

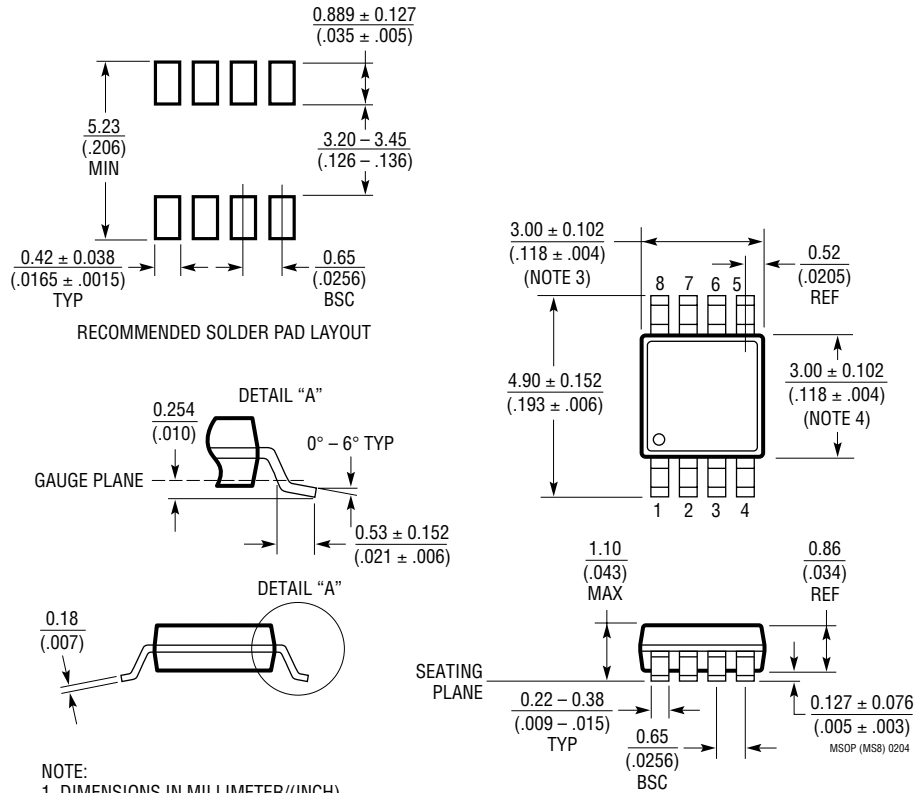

**NOTE:**

1. DIMENSIONS IN MILLIMETER/(INCH)
2. DRAWING NOT TO SCALE
3. DIMENSION DOES NOT INCLUDE MOLD FLASH, PROTRUSIONS OR GATE BURRS.  
MOLD FLASH, PROTRUSIONS OR GATE BURRS SHALL NOT EXCEED 0.152mm (.006") PER SIDE
4. DIMENSION DOES NOT INCLUDE INTERLEAD FLASH OR PROTRUSIONS.  
INTERLEAD FLASH OR PROTRUSIONS SHALL NOT EXCEED 0.152mm (.006") PER SIDE
5. LEAD COPLANARITY (BOTTOM OF LEADS AFTER FORMING) SHALL BE 0.102mm (.004") MAX

# PACKAGE DESCRIPTION

**DD Package**  
**8-Lead Plastic DFN (3mm × 3mm)**  
 (Reference LTC DWG # 05-08-1698)

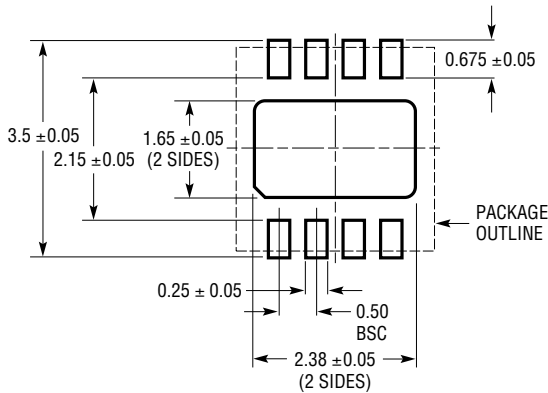

RECOMMENDED SOLDER PAD PITCH AND DIMENSIONS

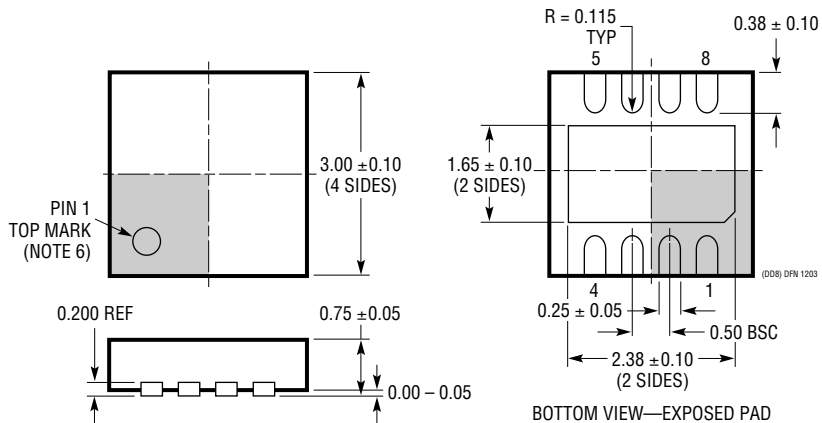

- NOTE:
1. DRAWING TO BE MADE A JEDEC PACKAGE OUTLINE M0-229 VARIATION OF (WEED-1)
  2. DRAWING NOT TO SCALE
  3. ALL DIMENSIONS ARE IN MILLIMETERS
  4. DIMENSIONS OF EXPOSED PAD ON BOTTOM OF PACKAGE DO NOT INCLUDE MOLD FLASH. MOLD FLASH, IF PRESENT, SHALL NOT EXCEED 0.15mm ON ANY SIDE
  5. EXPOSED PAD SHALL BE SOLDER PLATED
  6. SHADED AREA IS ONLY A REFERENCE FOR PIN 1 LOCATION ON TOP AND BOTTOM OF PACKAGE

