

1. PART NO. EXPRESSION :

L 8 2 6 - 1 R 0 M F
 (a) (b) (c)(d)

- (a) Series code
- (b) Inductance code : 1R0 = 1.0uH
- (c) Tolerance code : M = ±20%
- (d) F : Lead Free

2. CONFIGURATION & DIMENSIONS :

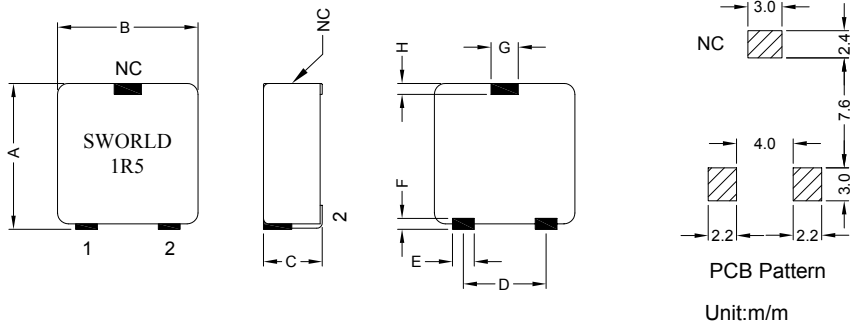

A	B	C	D	F	G	H
10.3±0.3	10.0±0.3	5.0±0.2	6.5±0.5	2.0±0.3	2.5±0.3	1.5±0.3

3. SCHEMATIC :

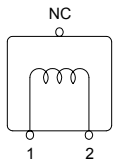

4. MATERIALS :

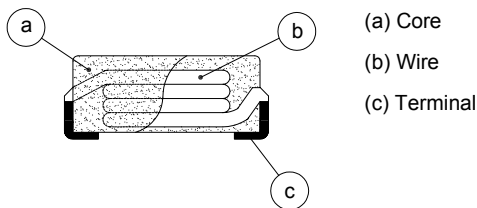

5. FEATURES :

- a) Shielded Construction
- b) Frequency up to 5MHz



RoHS Compliant

NOTE : Specifications subject to change without notice. Please check our website for latest information.

15.01.2008

6. GENERAL SPECIFICATION :

- a) Test Freq. : 100KHz/0.25VDC
- b) Ambient Temp. : 20°C
- c) Operating Temp. : -55°C to +125°C
- d) Storage Temp. : -55°C to +125°C
- e) Heat Rated Current (I_{rms}) : Will cause the coil temp. rise approximately $\Delta T=40^{\circ}\text{C}$ without core loss.
- f) Saturation Current (I_{sat}) : Will cause L₀ to drop approximately 20% typ.
- g) Part Temperature (Ambient+Temp. Rise) : Should not exceed 125°C under worst case operating conditions.

7. ELECTRICAL CHARACTERISTICS :

Part No.	E (mm) ±0.3	Inductance L ₀ (μH) ±20% @ 0 Adc	I _{rms} (A) Max.	I _{sat} (A) Max.	DCR (m Ω) Max.
L826-R56MF	1.5	0.56	23	30	1.8
L826-1R2MF	1.5	1.20	18	20	2.9
L826-1R5MF	1.5	1.50	17	18	3.5
L826-2R2MF	1.3	2.20	14	16	4.8
L826-3R3MF	1.3	3.30	12	14	7.3
L826-4R7MF	1.2	4.70	10	12	11



RoHS Compliant

NOTE : Specifications subject to change without notice. Please check our website for latest information.

15.01.2008



SUPERWORLD ELECTRONICS (S) PTE LTD

8. CHARACTERISTICS CURVES :

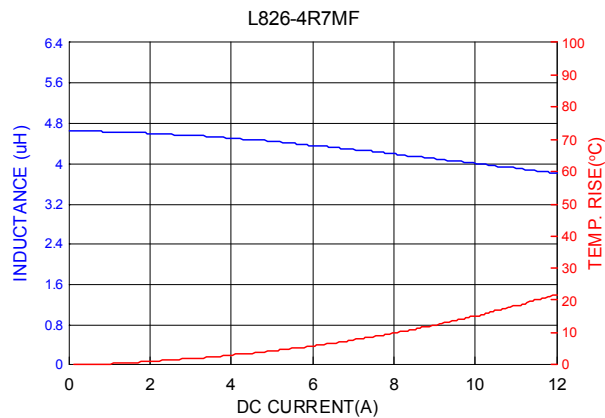
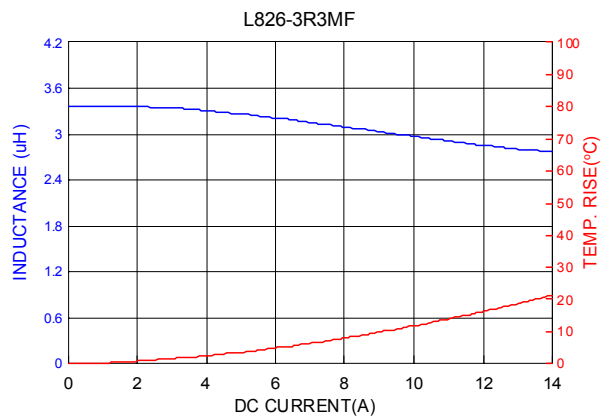
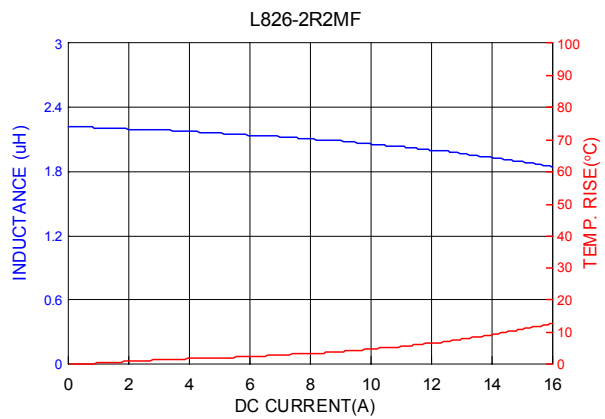
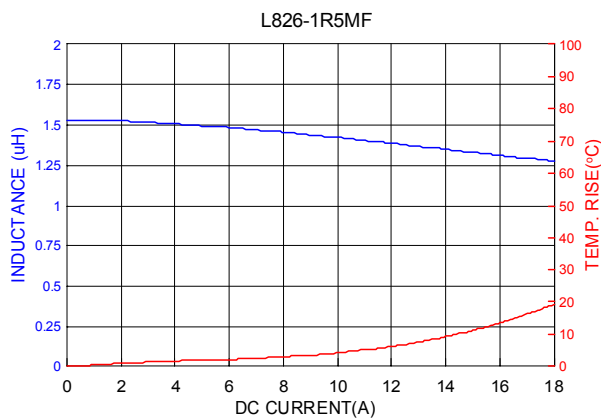
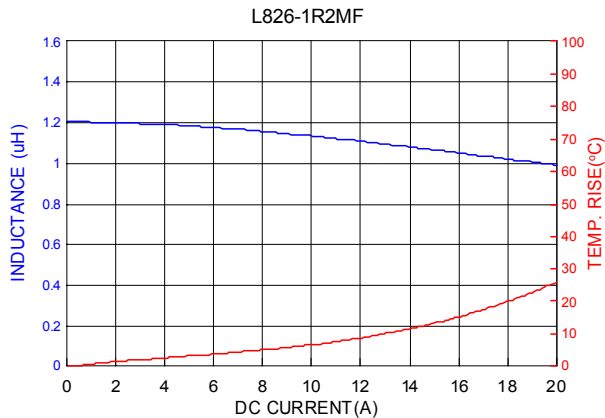
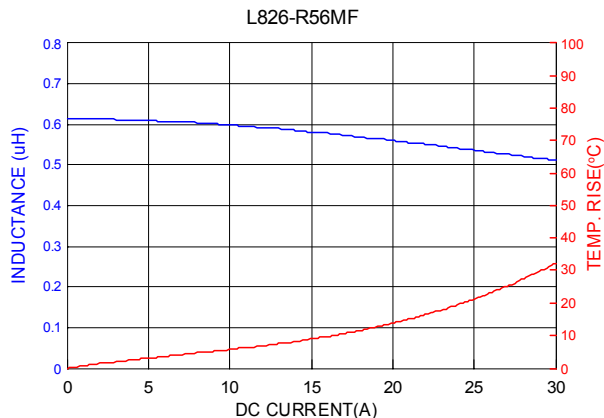

RoHS Compliant

NOTE : Specifications subject to change without notice. Please check our website for latest information.

15.01.2008



SUPERWORLD ELECTRONICS (S) PTE LTD

9. CORE LOSS :

100KHz and 500KHz

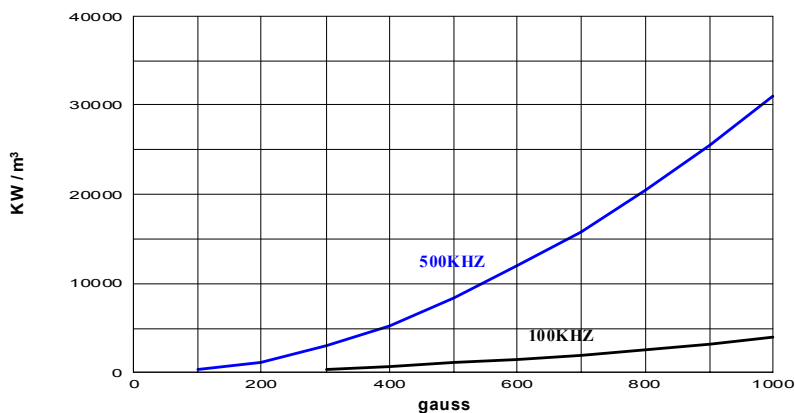

material gauss \ loss	100KHz	500KHz
100	-	266
200	-	1,234
300	351.7	2,932
400	665.9	5,195
500	1,039	8,336
600	1,471	12,025
700	1,923	15,715
800	2,537	20,444
900	3,148	25,429
1000	3,902	31,002

100KHz

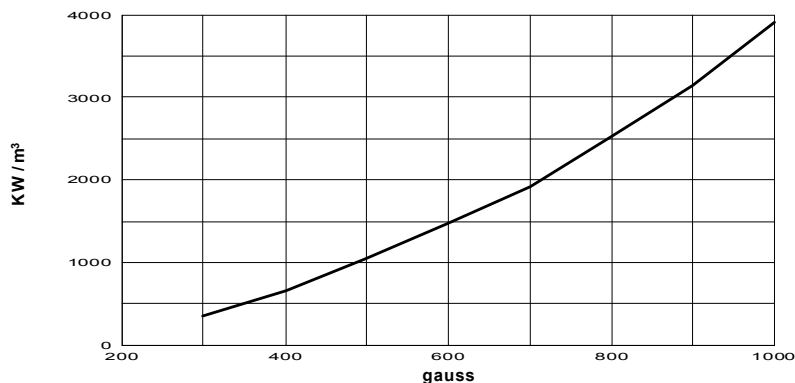

material gauss \ loss	100KHz
300	351.7
400	665.9
500	1,039
600	1,471
700	1,923
800	2,537
900	3,148
1000	3,902

500KHz

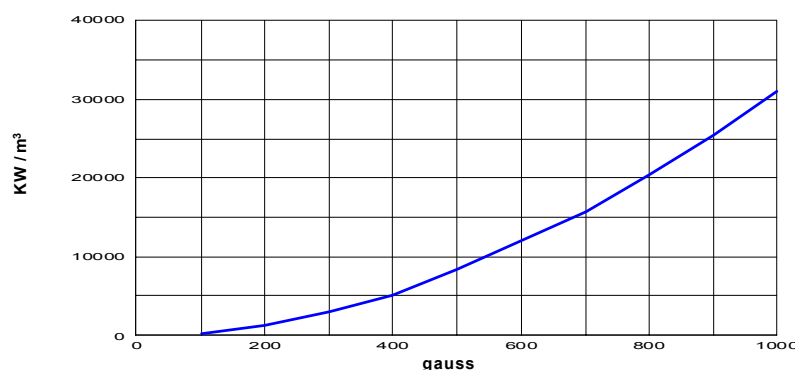

material gauss \ loss	500KHz
100	266
200	1,234
300	2,932
400	5,195
500	8,336
600	12,025
700	15,715
800	20,444
900	25,429
1000	31,002



RoHS Compliant

NOTE : Specifications subject to change without notice. Please check our website for latest information.

15.01.2008



SUPERWORLD ELECTRONICS (S) PTE LTD

10. RELIABILITY AND TEST CONDITION :

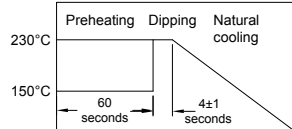
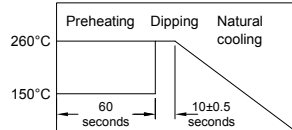
ITEM	PERFORMANCE	TEST CONDITION														
Electrical Characteristics Test																
Inductance	Refer to standard electrical characteristics list	HP4284A, CH11025, CH3302, CH1320, CH1320S LCR meter.														
DCR		CH16502, Agilent33420A Micro-Ohm Meter.														
Heat Rated Current (Irms)		Irms(A) will cause the coil temperature rise approximately $\Delta T=40^{\circ}\text{C}$ without core loss 1. Applied the allowed DC current 2. Temperature measured by digital surface thermometer														
Saturation Current (Isat)		Isat(A) will cause Lo to drop approximately 20% typical														
Mechanical Performance Test																
Solderability Test	More than 90% of the terminal electrode should be covered with solder.	Preheat : 150°C , 60sec. Solder : Sn99.95-Cu0.05 Solder Temperature : $230\pm 5^{\circ}\text{C}$ Flux for lead free : rosin Dip Time : 4 ± 1 sec. 														
Solder Heat Resistance	1. Appearance : No significant abnormality 2. Inductance change : Within $\pm 20\%$	Preheat : 150°C , 60sec. Solder : Sn99.95-Cu0.05 Solder Temperature : $260\pm 5^{\circ}\text{C}$ Flux for lead free : rosin Dip Time : 10 ± 0.5 sec. 														
Reliability Test																
High Temperature Life Test	1. Appearance : No damage 2. Inductance : Within $\pm 20\%$ of initial value. No disconnection or short circuit.	Temperature : $125\pm 5^{\circ}\text{C}$ Time : 500 ± 12 hours Measure at room temperature after placing for 2 to 3 hrs.														
Low Temperature Life Test		Temperature : $-55\pm 5^{\circ}\text{C}$ Time : 500 ± 12 hours Measure at room temperature after placing for 2 to 3 hrs.														
Thermal Shock		Conditions of 1 cycle. <table border="1" data-bbox="924 1514 1287 1646"> <thead> <tr> <th>Step</th> <th>Temperature ($^{\circ}\text{C}$)</th> <th>Times (min.)</th> </tr> </thead> <tbody> <tr> <td>1</td> <td>-55 ± 3</td> <td>30 ± 3</td> </tr> <tr> <td>2</td> <td>Room Temperature</td> <td>Within 3</td> </tr> <tr> <td>3</td> <td>$+125\pm 3$</td> <td>30 ± 3</td> </tr> <tr> <td>4</td> <td>Room Temperature</td> <td>Within 3</td> </tr> </tbody> </table> Total : 5 cycles Measure at room temperature after placing for 2 to 3 hrs.	Step	Temperature ($^{\circ}\text{C}$)	Times (min.)	1	-55 ± 3	30 ± 3	2	Room Temperature	Within 3	3	$+125\pm 3$	30 ± 3	4	Room Temperature
Step	Temperature ($^{\circ}\text{C}$)	Times (min.)														
1	-55 ± 3	30 ± 3														
2	Room Temperature	Within 3														
3	$+125\pm 3$	30 ± 3														
4	Room Temperature	Within 3														
Humidity Resistance	1. Appearance : No damage 2. Inductance : Within $\pm 20\%$ of initial value. No disconnection or short circuit.	Temperature : $40\pm 5^{\circ}\text{C}$ Humidity : 90% to 95% Applied Current : Rated Current Time : 500 ± 12 hours Measure at room temperature after placing for 2 to 3 hrs.														

NOTE : Specifications subject to change without notice. Please check our website for latest information.

15.01.2008



11. SOLDERING AND MOUNTING :

11-1. Recommended PC Board Pattern

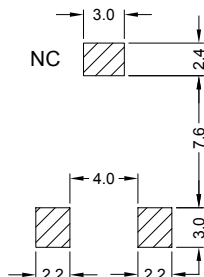

11-2. Soldering

Mildly activated rosin fluxes are preferred. The minimum amount of solder can lead to damage from the stresses caused by the difference in coefficients of expansion between solder, chip and substrate. Our terminations are suitable for all wave and re-flow soldering systems. If hand soldering cannot be avoided, the preferred technique is the utilization of hot air soldering tools.

11-2.1 Solder Re-flow :

Recommended temperature profiles for re-flow soldering in Figure 1.

11-2.2 Soldering Iron (Figure 2) :

Products attachment with soldering iron is discouraged due to the inherent process control limitations. In the event that a soldering iron must be employed the following precautions are recommended.

Note :

- Preheat circuit and products to 150°C.
- 280°C tip temperature (max)
- Never contact the ceramic with the iron tip
- 1.0mm tip diameter (max)
- Use a 20 watt soldering iron with tip diameter of 1.0mm
- Limit soldering time to 3 secs.

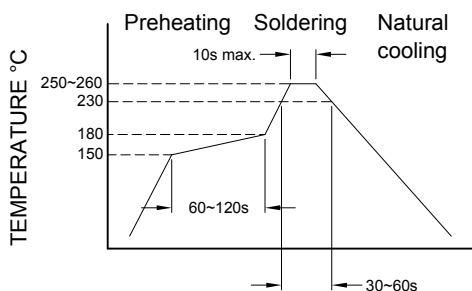

Figure 1. Re-flow Soldering

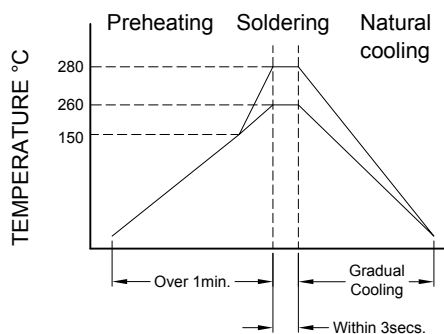

Figure 2. Iron Soldering



RoHS Compliant

NOTE : Specifications subject to change without notice. Please check our website for latest information.

15.01.2008



SUPERWORLD ELECTRONICS (S) PTE LTD

PG. 6

12. PACKAGING INFORMATION :

12-1. Reel Dimension

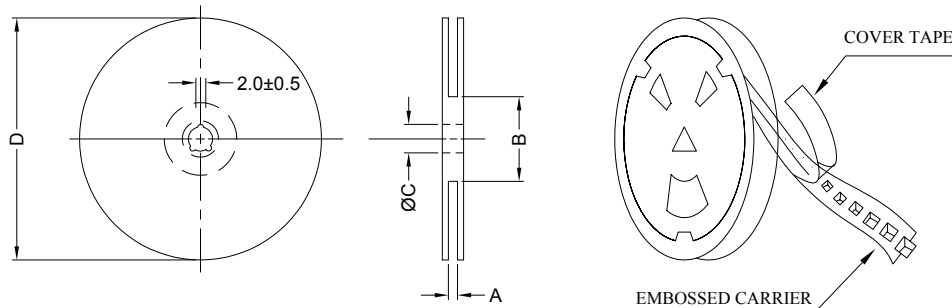

Type	A(mm)	B(mm)	C(mm)	D(mm)
13" x 24mm	24.0±0.5	100±2.0	13.5±0.5	330

12-2 Tape Dimension

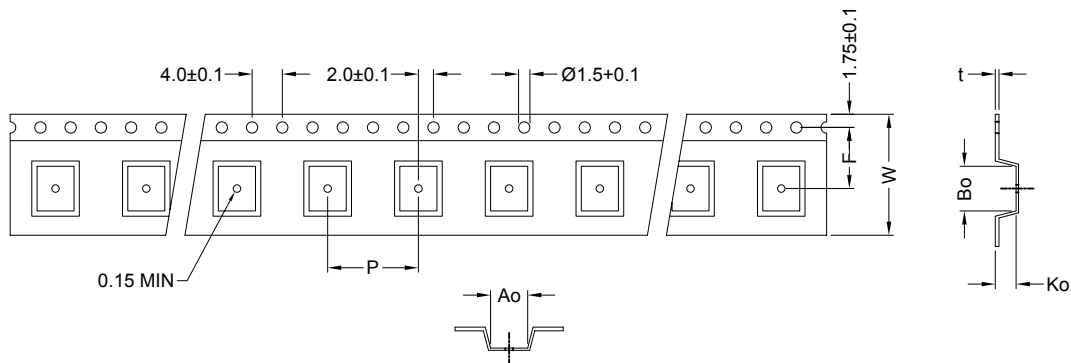

Series	Ao(mm)	Bo(mm)	Ko(mm)	P(mm)	W(mm)	F(mm)	t(mm)
L826	11.0±0.1	10.4±0.1	5.4±0.1	16.0±0.1	24.0±0.3	11.5±0.05	0.4±0.05

12-3. Packaging Quantity

Size	L826
Chip / Reel	500
Inner Box	1000
Carton	4000



RoHS Compliant

NOTE : Specifications subject to change without notice. Please check our website for latest information.

15.01.2008



SUPERWORLD ELECTRONICS (S) PTE LTD

12-4. Tearing Off Force

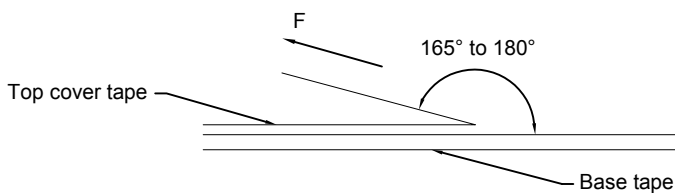

The force for tearing off cover tape is 15 to 60 grams in the arrow direction under the following conditions.

Room Temp. (°C)	Room Humidity (%)	Room atm (hPa)	Tearing Speed (mm/min)
5~35	45~85	860~1060	300

Application Notice

1. Storage Conditions :

To maintain the solderability of terminal electrodes :

- a) Temperature and humidity conditions : Less than 30°C and 70% RH.
- b) Recommended products should be used within 6 months from the time of delivery.
- c) The packaging material should be kept where no chlorine or sulfur exists in the air.

2. Transportation :

- a) Products should be handled with care to avoid damage or contamination from perspiration and skin oils.
- b) The use of tweezers or vacuum pick up is strongly recommended for individual components.
- c) Bulk handling should ensure that abrasion and mechanical shock are minimized.



RoHS Compliant

NOTE : Specifications subject to change without notice. Please check our website for latest information.

15.01.2008



SUPERWORLD ELECTRONICS (S) PTE LTD