

**WHITE LED STEP-UP CONVERTER**

**AP3031**

**General Description**

The AP3031 is an inductor-based DC/DC boost converter designed to drive LED arrays. 1.4A switching current allows AP3031 to be used in different 7' to 10' LCD panel backlights (3\*13 LED arrays typically).

A constant frequency 1MHz PWM control scheme is employed in this IC, which means tiny external components can be used. Specifically, 1mm tall 4.7μH inductor and 0.47μF output capacitor for the typical application is sufficient.

The over output voltage protection is equipped in AP3031, which protects the IC under open load condition. The AP3031 includes UVLO, soft-start, current limit and OTSD to protect the circuit.

The AP3031 is available in standard SOT-23-6, TSOT-23-6 and SOIC-8 packages.

**Features**

- Up to 92% Efficiency ( $V_{IN}=9V, I_{OUT}=260mA$ )
- Up to 84% Efficiency ( $V_{IN}=5V, I_{OUT}=260mA$ )
- Fast 1MHz Switching Frequency
- Wide Input Voltage Range: 2.7V to 16V
- Low 200mV Feedback Voltage
- Output Over Voltage Protection
- Cycle by Cycle Current Limit: 1.4A
- Built-in Soft-start
- Built-in Standby Mode to Achieve High Frequency PWM Dimming
- Built-in Thermal Shutdown Function
- Under Voltage Lockout

**Applications**

- 7' to 10' LCD Panels
- Digital Photo Frame
- GPS Receiver
- EPC
- PDVD

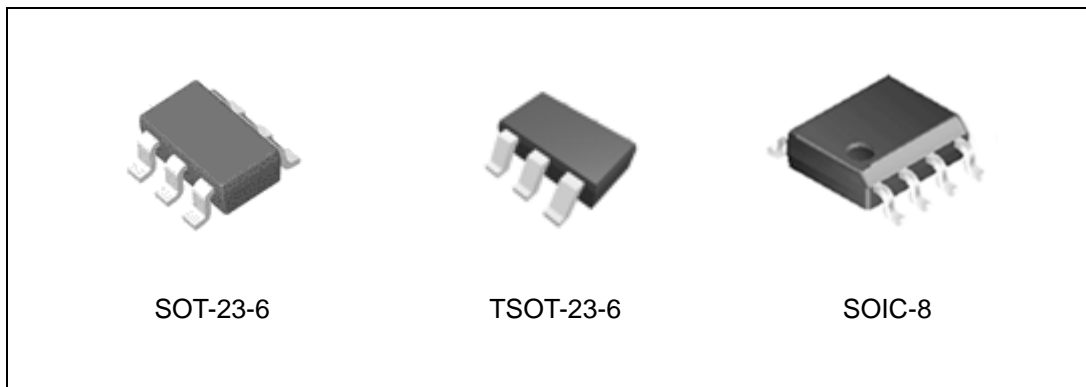

Figure 1. Package Types of AP3031

**WHITE LED STEP-UP CONVERTER**

**AP3031**

**Pin Configuration**

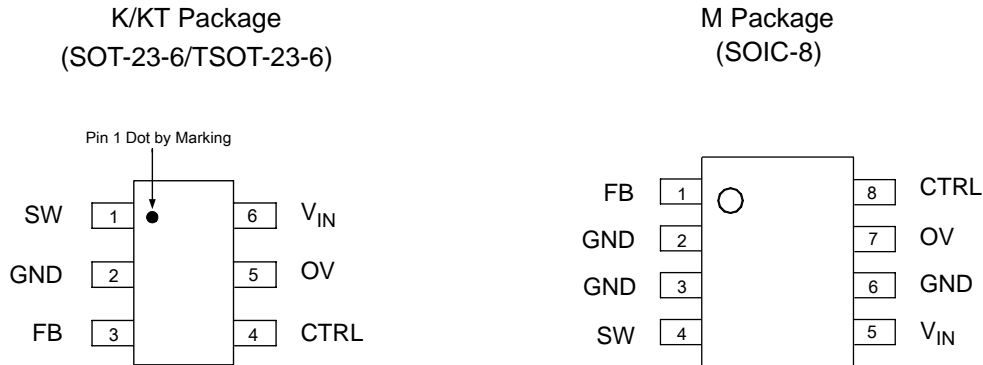

Figure 2. Pin Configuration of AP3031 (Top View)

**Pin Description**

Pin Number		Pin Name	Function
6-Pin	8-Pin		
1	4	SW	Switch Pin. Connect external inductor and Schottky
2	2, 3, 6	GND	Ground Pin
3	1	FB	Voltage Feedback Pin. Reference voltage is 200mV
4	8	CTRL	Enable and Dimming Control Pin. Connect to a high input to enable the IC or a low input to disable the IC. If logic low time is more than about 0.7ms and then enable the IC, the AP3031 will soft start to protect system departments. If logic low time is less than about 0.7ms and then enable the IC, the AP3031 will hold on standby mode and start directly to achieve high frequency dimming
5	7	OV	Over-voltage Protection Input Pin. Connect to the output directly. On OVP condition, the output voltage will be clamped
6	5	V <sub>IN</sub>	Input Supply Pin. Must be locally bypassed

**WHITE LED STEP-UP CONVERTER**

**AP3031**

**Functional Block Diagram**

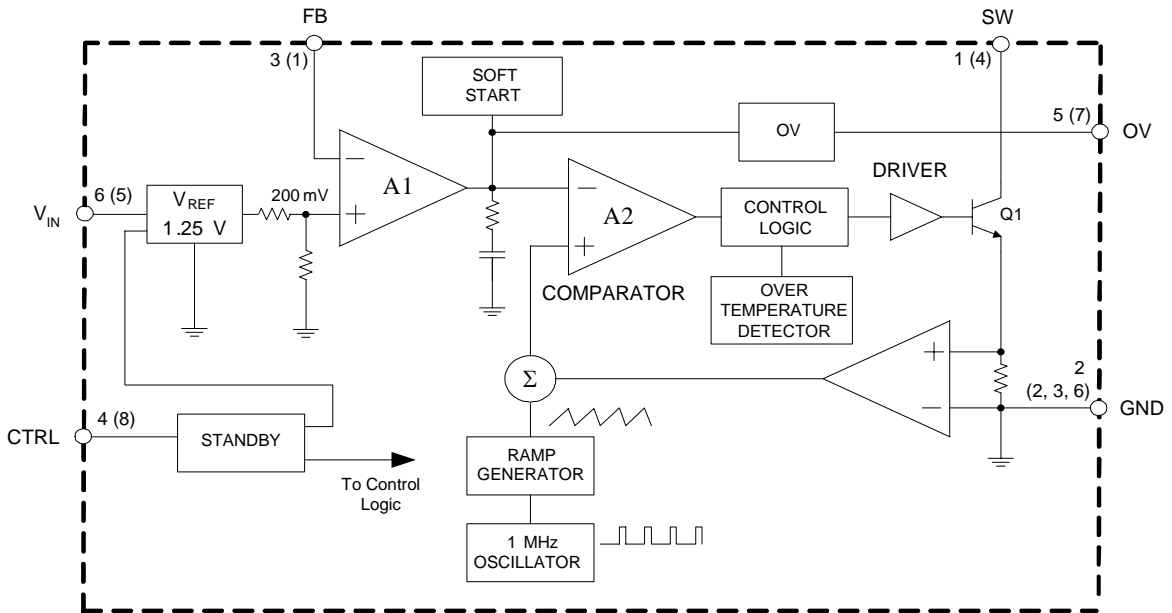

A (B)  
A SOT-23-6/TSOT-23-6  
B SOIC-8

Figure 3. Functional Block Diagram of AP3031

**Ordering Information**

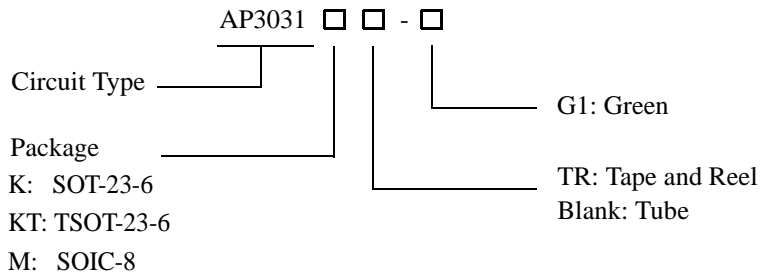

Package	Temperature Range	Part Number	Marking ID	Packing Type
SOT-23-6	-40 to 85°C	AP3031KTR-G1	GEC	Tape & Reel
TSOT-23-6		AP3031KTTR-G1	L1E	Tape & Reel
SOIC-8		AP3031M-G1	3031M-G1	Tube
		AP3031MTR-G1	3031M-G1	Tape & Reel

BCD Semiconductor's Pb-free products, as designated with "G1" suffix in the part number, are RoHS compliant and green.

**WHITE LED STEP-UP CONVERTER****AP3031****Absolute Maximum Ratings (Note 1)**

Parameter	Symbol	Value		Unit
Input Voltage	$V_{IN}$	20		V
SW Voltage	$V_{SW}$	38		V
FB Voltage	$V_{FB}$	20		V
CTRL Voltage	$V_{CTRL}$	20		V
Thermal Resistance (Junction to Ambient, No Heat Sink)	$\theta_{JA}$	SOT-23-6/TSOT-23-6	265	°C/W
		SOIC-8	120	
Operating Junction Temperature	$T_J$	150		°C
Storage Temperature Range	$T_{STG}$	-65 to 150		°C
Lead Temperature (Soldering, 10sec)	$T_{LEAD}$	260		°C
ESD (Machine Model)		600		V
ESD (Human Body Model)		4000		V

Note 1: Stresses greater than those listed under "Absolute Maximum Ratings" may cause permanent damage to the device. These are stress ratings only, and functional operation of the device at these or any other conditions beyond those indicated under "Recommended Operating Conditions" is not implied. Exposure to "Absolute Maximum Ratings" for extended periods may affect device reliability.

**Recommended Operating Conditions**

Parameter	Symbol	Min	Max	Unit
Operating Temperature Range	$T_{OP}$	-40	85	°C
Input Voltage	$V_{IN}$	2.7	16	V
CTRL Voltage	$V_{CTRL}$		16	V

**WHITE LED STEP-UP CONVERTER****AP3031****Electrical Characteristics**(V<sub>IN</sub>=5.0V, V<sub>CTRL</sub>=5.0V, T<sub>A</sub>=25°C, unless otherwise specified.)

Parameter	Symbol	Conditions	Min	Typ	Max	Unit
Operating Voltage	V <sub>IN</sub>		2.7		16	V
Feedback Voltage (Note 2)	V <sub>FB</sub>	I <sub>OUT</sub> =20mA, 3 LEDs, T <sub>A</sub> =-40°C to 85°C	<b>188</b>	<b>200</b>	<b>212</b>	mV
FB Pin Bias Current	I <sub>FB</sub>			35	100	nA
Quiescent Current	I <sub>Q</sub>	V <sub>FB</sub> =V <sub>IN</sub> , no switching	3.0	4.0	5.0	mA
Shutdown Quiescent Current	I <sub>SHDN</sub>	V <sub>CTRL</sub> =0V	20	50	80	μA
Switching Frequency	f		0.75	1	1.3	MHz
Maximum Duty Cycle	D <sub>MAX</sub>		90	93		%
Switch Current Limit (Note 3)	I <sub>LIMIT</sub>	D=60%	1.2	1.4		A
Switch V <sub>CE</sub> Saturation Voltage	V <sub>CESAT</sub>	I <sub>SW</sub> =0.6A		300		mV
Switch Leakage Current		V <sub>SW</sub> =16V		0.01	5	μA
CTRL Pin Voltage	V <sub>CTRL</sub>	Active high	1.8			V
		Active low			0.5	
CTRL Pin Bias Current	I <sub>CTRL</sub>		35	60	85	μA
OVP Voltage	V <sub>OVP</sub>			17		V
Soft-start Time	t <sub>SS</sub>			250		μs
Standby Time	t <sub>STB</sub>			0.7		ms
Thermal Shutdown	T <sub>OTSD</sub>			155		°C
Thermal Resistance (Junction to Case)	θ <sub>JC</sub>			60		°C/W

Note 2: The bold type specifications of full temperature range are guaranteed by design (GBD).

Note 3: The switch current limit is related to duty cycle. Please refer to Figure 15 for detail.



**WHITE LED STEP-UP CONVERTER**

**AP3031**

**Typical Performance Characteristics**

(WLED forward voltage ( $V_F$ )=3.2V at  $I_F$ =20mA, unless otherwise noted.)

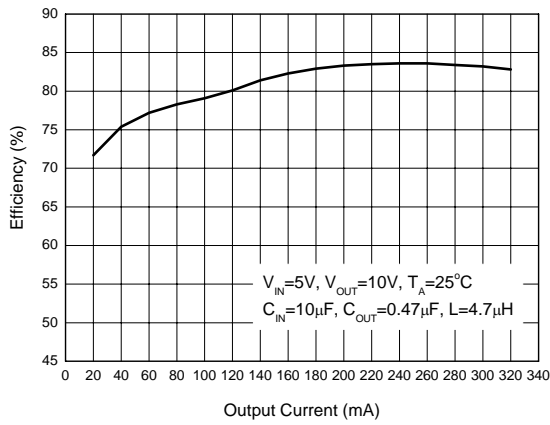

Figure 4. Efficiency vs. Output Current

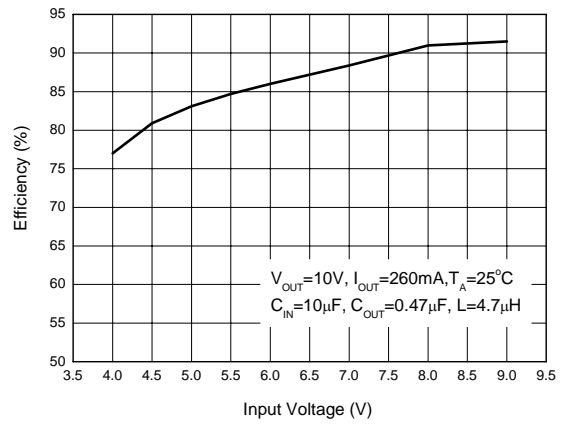

Figure 5. Efficiency vs. Input Voltage

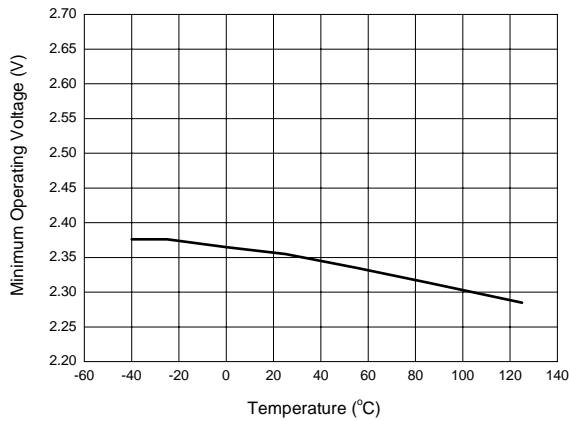

Figure 6. Minimum Operating Voltage vs. Temperature

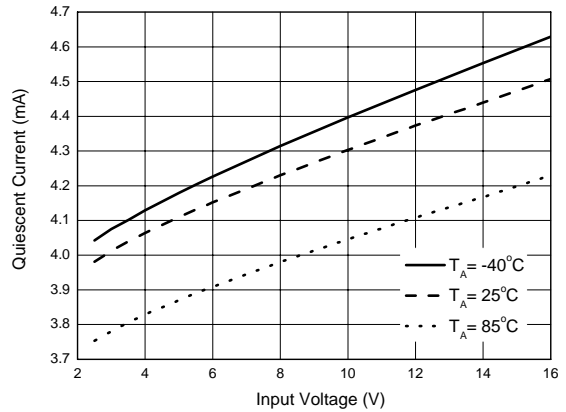

Figure 7. Quiescent Current vs. Input Voltage



**WHITE LED STEP-UP CONVERTER**

**AP3031**

**Typical Performance Characteristics (Continued)**

(WLED forward voltage ( $V_F$ )=3.2V at  $I_F$ =20mA, unless otherwise noted.)

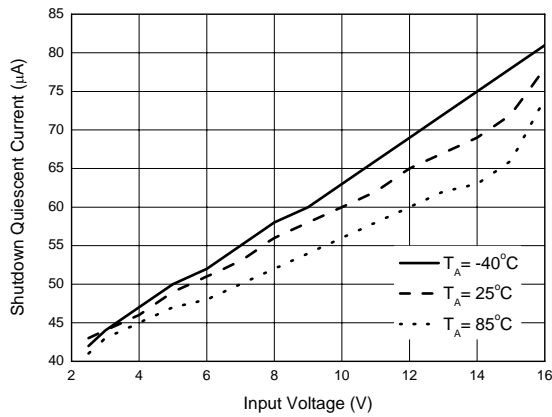

Figure 8. Shutdown Quiescent Current vs. Input Voltage

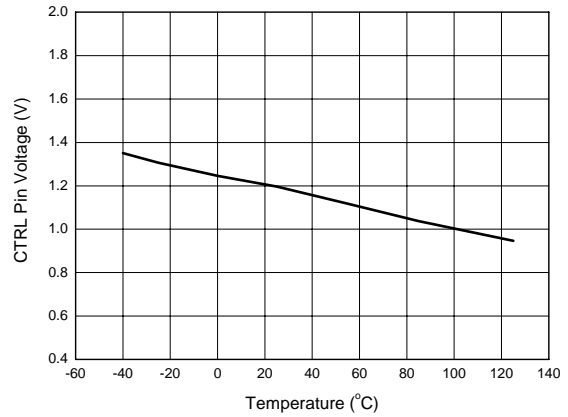

Figure 9. CTRL Pin Voltage vs. Temperature

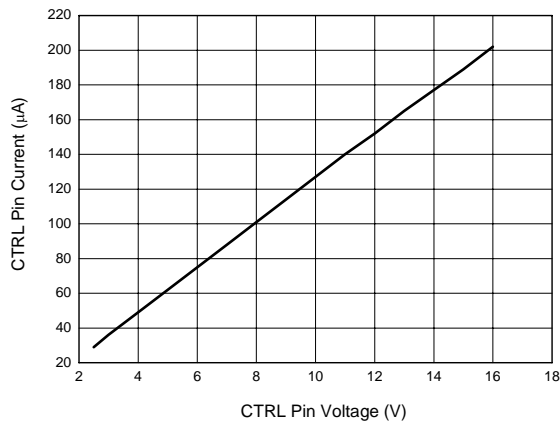

Figure 10. CTRL Pin Current vs. CTRL Pin Voltage

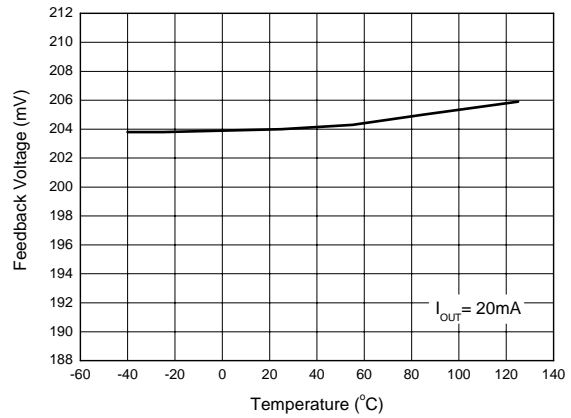

Figure 11. Feedback Voltage vs. Temperature



**WHITE LED STEP-UP CONVERTER**

**AP3031**

**Typical Performance Characteristics (Continued)**

(WLED forward voltage ( $V_F$ )=3.2V at  $I_F$ =20mA, unless otherwise noted.)

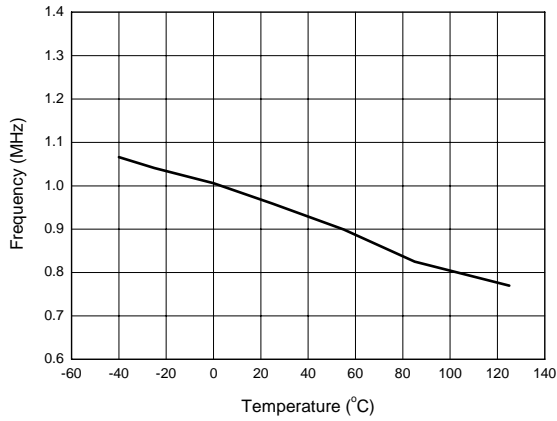

Figure 12. Frequency vs. Temperature

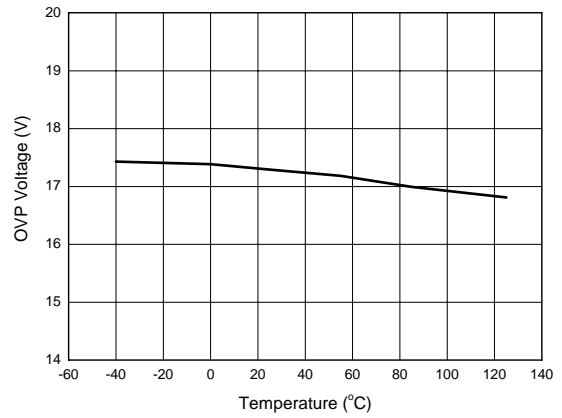

Figure 13. OVP Voltage vs. Temperature

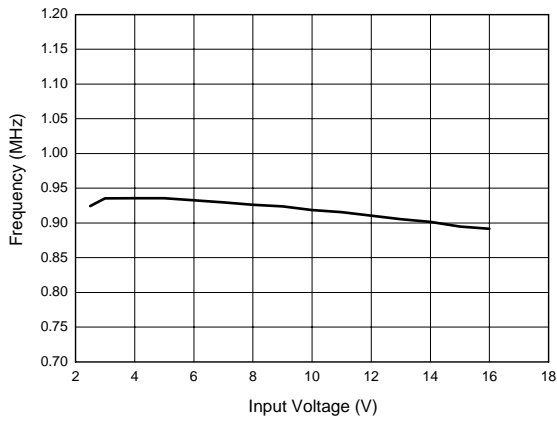

Figure 14. Frequency vs. Input Voltage

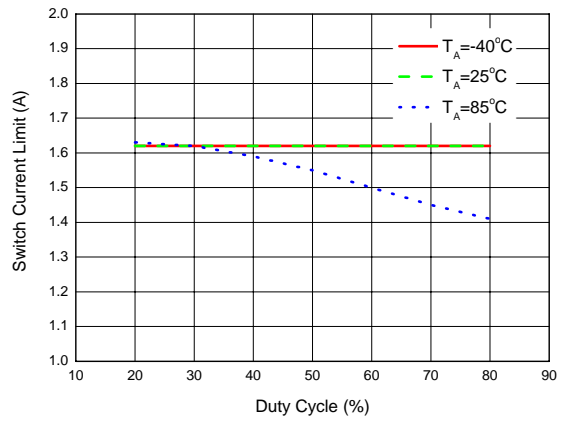

Figure 15. Switch Current Limit vs. Duty Cycle





**WHITE LED STEP-UP CONVERTER**

**AP3031**

**Typical Performance Characteristics (Continued)**

(WLED forward voltage ( $V_F$ )=3.2V at  $I_F$ =20mA, unless otherwise noted.)

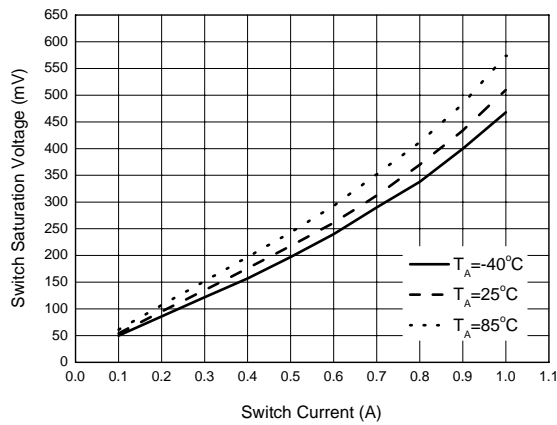

Figure 16. Switch Saturation Voltage vs. Switch Current

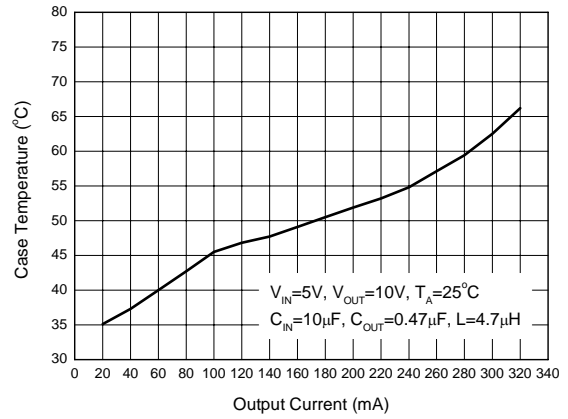

Figure 17. Case Temperature vs. Output Current

**WHITE LED STEP-UP CONVERTER**

**AP3031**

**Application Information**

**Operation**

The AP3031 is a boost DC-DC converter which uses a constant frequency, current mode control scheme to provide excellent line and load regulation. Operation can be best understood by referring to Figure 3 and Figure 24.

At the start of each oscillator cycle, switch Q1 turns on. The switch current will increase linearly. The voltage on sense resistor is proportional to the switch current. The output of the current sense amplifier is added to a stabilizing ramp and the result is fed into the non-inversion input of the PWM comparator A2. When this voltage exceeds the output voltage level of the error amplifier A1, the switch is turned off.

It is clear that the voltage level at inversion input of A2 sets the peak current level to keep the output in regulation. This voltage level is the output signal of error amplifier A1, and is the amplified signal of the voltage difference between feedback voltage and reference voltage of 200mV. So, a constant output current can be provided by this operation mode.

**LED Current Control**

Refer to Figure 24, the LED current is controlled by the feedback resistor  $R_{ISET}$ . LEDs' current accuracy is determined by the feedback voltage and resistor  $R_{ISET}$ , so the precise resistors are preferred. The resistance of  $R_{ISET}$  is in inverse proportion to the LED current since the feedback reference is fixed at 200mV. The relation for  $R_{ISET}$  and LED current ( $I_{LED}$ ) can be expressed as below:

$$R_{ISET} = \frac{200mV}{I_{LED}}$$

**Over Voltage Protection**

The AP3031 has an internal open load protection circuit. When the LEDs are disconnected from circuit or fail open, the output voltage is clamped at about 17V. The AP3031 will switch at a low frequency, and minimize current to avoid input voltage drop.

**Soft Start**

The AP3031 has an internal soft start circuit to limit the inrush current during startup. If logic low time on CTRL pin is more than about 0.7ms and then enable the IC, the AP3031 will start smoothly to protect the supplier. The time of startup is controlled by internal soft-start capacitor. Details please refer to Figure 18.

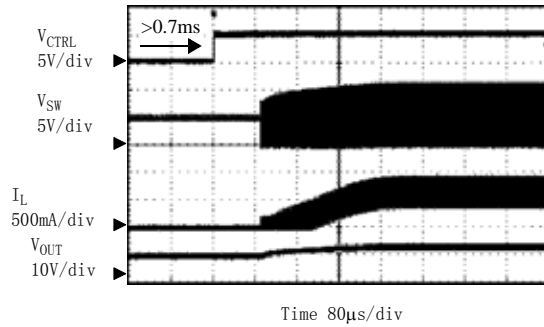

Figure 18. Soft-start Waveform  
 $V_{IN}=5V$ ,  $3 \times 13$  LEDs,  $I_{LED}=260mA$

**Standby and Dimming**

To avoid audio noise and achieve high frequency dimming, AP3031 is equipped with standby function. If logic low time on CTRL pin is less than about 0.7ms and then enable the IC, the AP3031 will hold on standby mode and start directly to achieve high frequency dimming. Details please refer to Figure 19.

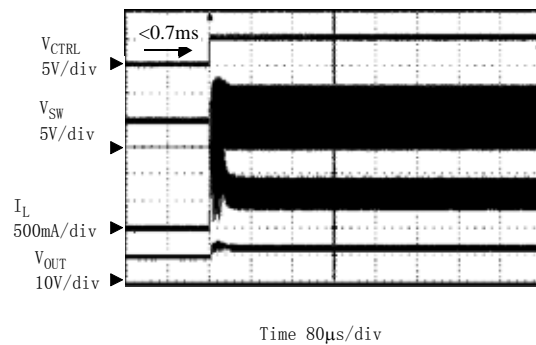

Figure 19. Standby Waveform

Two typical types of dimming control circuit are present as below. First, controlling CTRL Pin voltage to change operation state is a good choice. Second,

**WHITE LED STEP-UP CONVERTER**

**AP3031**

**Application Information (Continued)**

changing the feedback voltage to get appropriate duty and luminous intensity is also useful.

**(1) Adding a Control Signal to CTRL Pin**

Adding a PWM signal to CTRL pin directly, the AP3031 is turned on and off by this signal. When the PWM frequency is lower than 1kHz(Typ.), the IC works in the soft-start mode to dimming the light. On contrary, when the PWM frequency is higher than 1kHz(Typ.), the IC works in the standby mode: the converter ceaselessly switches off and directly starts to achieve light dimming. This standby function allows AP3031 to support high frequency dimming (up to 25kHz or higher) to avoid audio noise. More details please refer to Figure 20 and Figure 21.

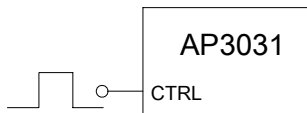
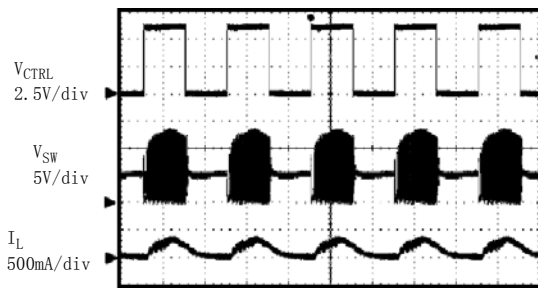

Figure 20. Dimming Control Using a PWM Signal in CTRL Pin



Time 20μs/div

Figure 21. High Frequency (25kHz) Dimming Waveform

**(2) Changing the Effective Feedback Voltage**

There are two popular methods to change the effective feedback voltage.

First, adding a constant DC voltage through a resistor divider to FB pin can control the dimming. Changing the DC voltage or resistor between the FB Pin and the DC voltage can get appropriate luminous intensity.

Comparing with all kinds of PWM signal control, this method features a stable output voltage and LEDs current. Please refer to Figure 22.

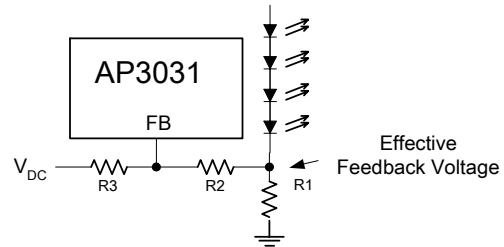

Figure 22. Dimming Control Using DC Voltage

Second, using a filtered PWM signal can do it. The filtered PWM signal can be considered as a varying and adjustable DC voltage, please refer to Figure 23.

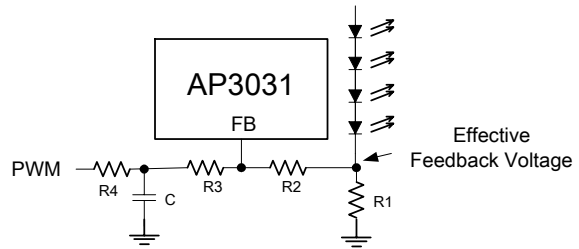

Figure 23. Dimming Control Using Filtered PWM Voltage

**WHITE LED STEP-UP CONVERTER**
**AP3031**
**Typical Application**

Figure 24. Typical Application of AP3031 (3×13 WLEDs)



**WHITE LED STEP-UP CONVERTER**

**AP3031**

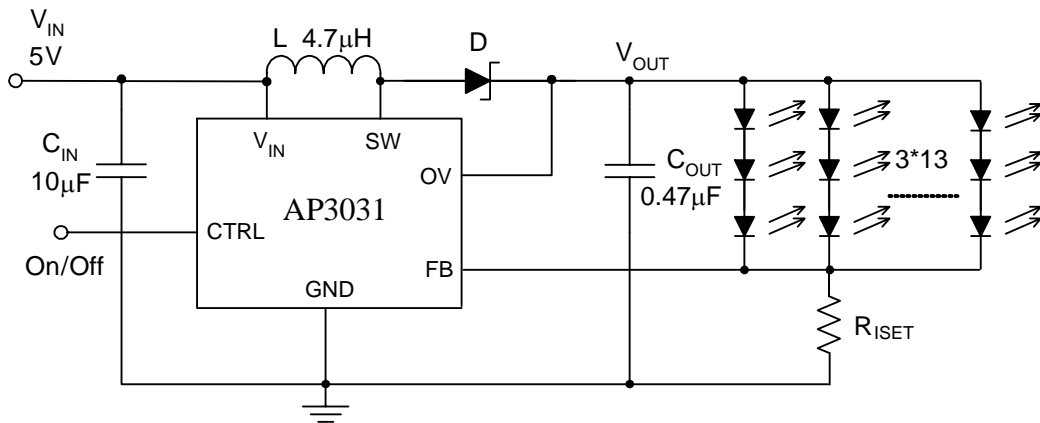
**Mechanical Dimensions**

**SOT-23-6**

**Unit: mm(inch)**

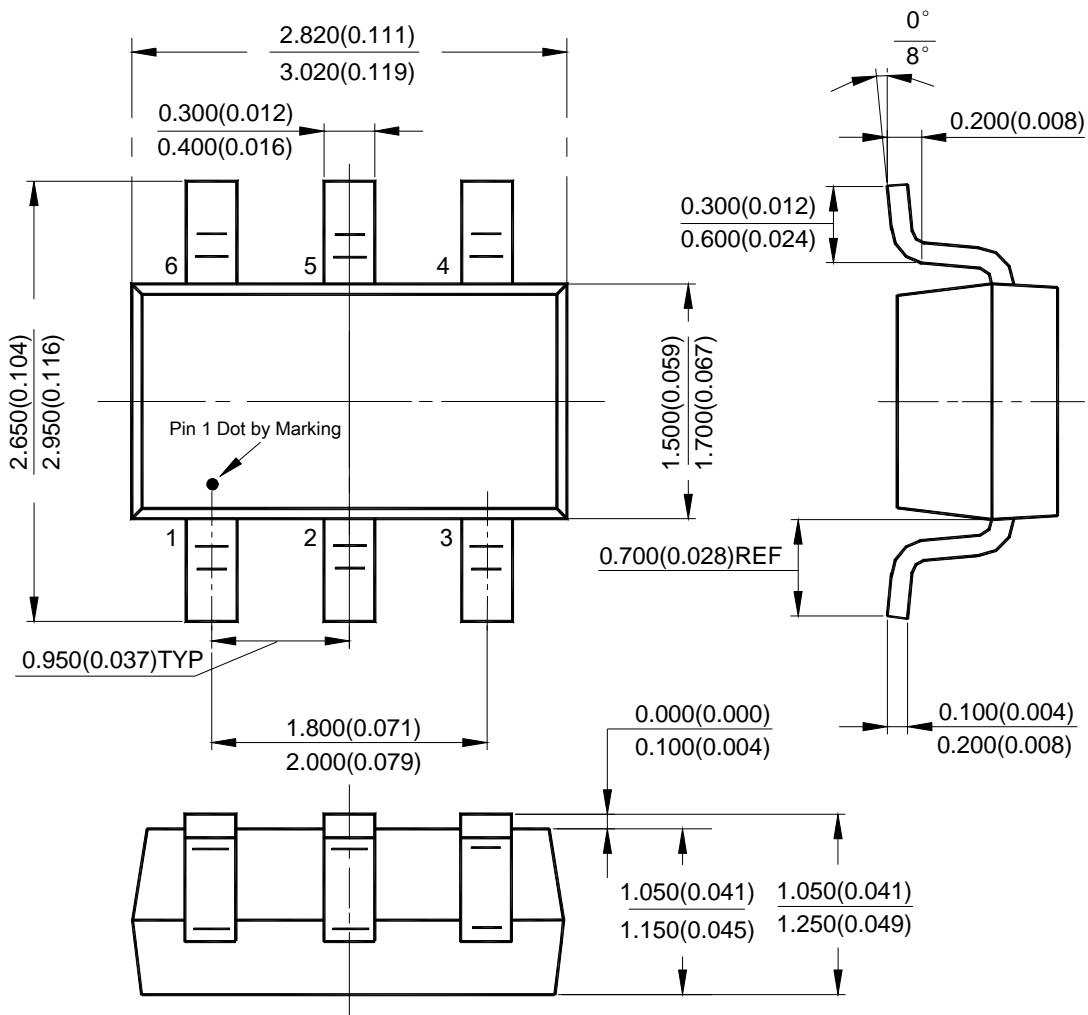



**WHITE LED STEP-UP CONVERTER**

**AP3031**

**Mechanical Dimensions (Continued)**

**TSOT-23-6**

**Unit: mm(inch)**

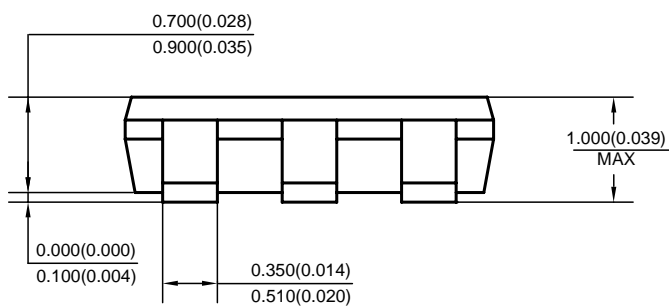
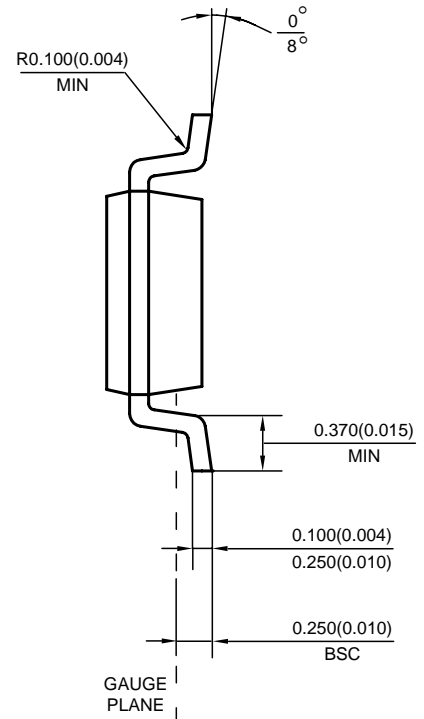
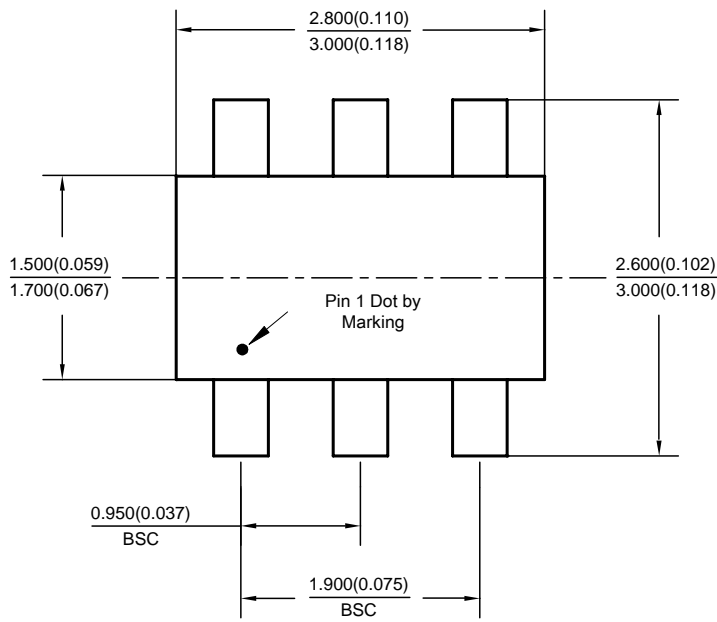



**WHITE LED STEP-UP CONVERTER**

**AP3031**

**Mechanical Dimensions (Continued)**

**SOIC-8**

**Unit: mm(inch)**

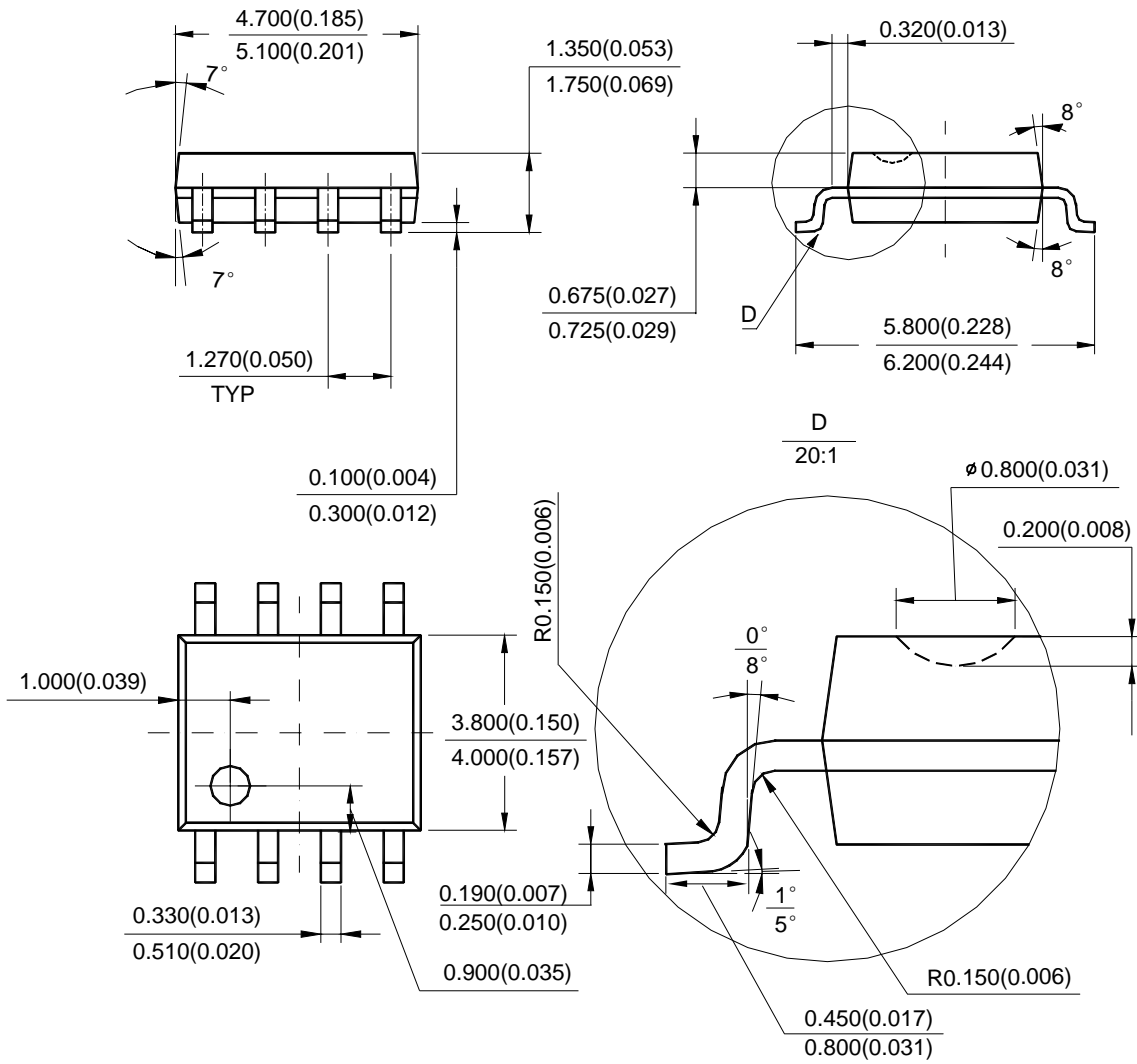

Note: Eject hole, oriented hole and mold mark is optional.



## **BCD Semiconductor Manufacturing Limited**

<http://www.bcdsemi.com>

### **IMPORTANT NOTICE**

BCD Semiconductor Manufacturing Limited reserves the right to make changes without further notice to any products or specifications herein. BCD Semiconductor Manufacturing Limited does not assume any responsibility for use of any its products for any particular purpose, nor does BCD Semiconductor Manufacturing Limited assume any liability arising out of the application or use of any its products or circuits. BCD Semiconductor Manufacturing Limited does not convey any license under its patent rights or other rights nor the rights of others.

---

#### **MAIN SITE**

##### **- Headquarters**

##### **BCD Semiconductor Manufacturing Limited**

No. 1600, Zi Xing Road, Shanghai Zizhu Science-based Industrial Park, 200241, China  
Tel: +86-21-24162266, Fax: +86-21-24162277

##### **- Wafer Fab**

##### **Shanghai SIM-BCD Semiconductor Manufacturing Co., Ltd.**

800 Yi Shan Road, Shanghai 200233, China  
Tel: +86-21-6485 1491, Fax: +86-21-5450 0008

#### **REGIONAL SALES OFFICE**

##### **Shenzhen Office**

**Shanghai SIM-BCD Semiconductor Manufacturing Co., Ltd., Shenzhen Office**  
Room E, 5F, Noble Center, No.1006, 3rd Fuzhong Road, Futian District, Shenzhen,  
518026, China  
Tel: +86-755-8826 7951  
Fax: +86-755-8826 7865

##### **Taiwan Office**

**BCD Semiconductor (Taiwan) Company Limited**  
4F, 298-1, Rui Guang Road, Nei-Hu District, Taipei,  
Taiwan  
Tel: +886-2-2656 2808  
Fax: +886-2-2656 2806

##### **USA Office**

**BCD Semiconductor Corp.**  
30920 Huntwood Ave. Hayward,  
CA 94544, USA  
Tel : +1-510-324-2988  
Fax: +1-510-324-2788