

1. PART NO. EXPRESSION :

PSB10041R8MZ F
 (a) (b) (c) (d)(e)(f)

- (a) Series code
- (b) Dimension code
- (c) Inductance code : 1R8 = 1.8uH
- (d) Tolerance code : K = ±10%, L = ±15%, M = ±20%
- (e) X, Y, Z : Standard part
- (f) F : Lead Free

2. CONFIGURATION & DIMENSIONS :

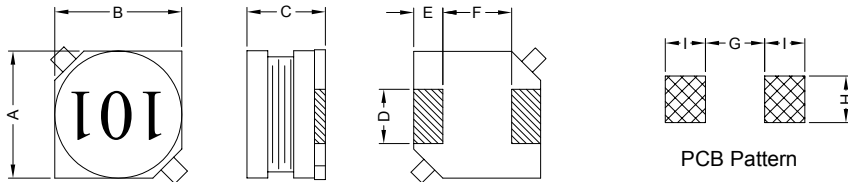

Unit:m/m

A	B	C	D	E	F	G	H	I
10.0±0.3	10.0±0.3	4.6±0.3	2.4±0.2	2.0±0.2	6.0±0.2	5.7 Ref.	2.8 Ref.	2.5 Ref.

3. SCHEMATIC :

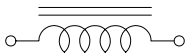

4. MATERIALS :

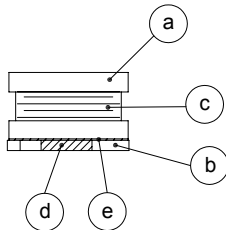

- (a) Core : DR Ferrite Core
- (b) Base : LCP
- (c) Wire : Enamelled Copper Wire
- (d) Terminal : Tinned Copper Plate
- (e) Adhesive : Epoxy

5. GENERAL SPECIFICATION :

- a) Temp. rise : 40°C Max.
- b) Rated current : $\Delta L/L0A = 10\%$ Max. at IDC
- c) Storage temp. : -40°C to +125°C
- d) Operating temp. : -40°C to +85°C
- e) Resistance to solder heat : 260°C.10 secs



RoHS Compliant

NOTE : Specifications subject to change without notice. Please check our website for latest information.

05.05.2008



SUPERWORLD ELECTRONICS (S) PTE LTD

6. ELECTRICAL CHARACTERISTICS :

Part No.	Inductance (μ H)	Test Frequency (Hz)	RDC (m Ω) Max.	IDC (A) Max.
PSB10041R8MZF	1.8 \pm 20%	1V / 100K	23	5.50
PSB10042R7MZF	2.7 \pm 20%	1V / 100K	25	5.00
PSB10043R9MZF	3.9 \pm 20%	1V / 100K	30	4.50
PSB10044R7MZF	4.7 \pm 20%	1V / 100K	35	4.00
PSB10046R8MZF	6.8 \pm 20%	1V / 100K	40	3.80
PSB1004100MZF	10.0 \pm 20%	1V / 100K	50	3.30
PSB1004120MZF	12.0 \pm 20%	1V / 100K	55	3.20
PSB1004150MZF	15.0 \pm 20%	1V / 100K	65	3.00
PSB1004180LZF	18.0 \pm 15%	1V / 100K	70	2.70
PSB1004220LZF	22.0 \pm 15%	1V / 100K	80	2.60
PSB1004270LZF	27.0 \pm 15%	1V / 100K	90	2.40
PSB1004330LZF	33.0 \pm 15%	1V / 100K	110	2.00
PSB1004390LZF	39.0 \pm 15%	1V / 100K	120	1.90
PSB1004470LZF	47.0 \pm 15%	1V / 100K	130	1.80
PSB1004560LZF	56.0 \pm 15%	1V / 100K	180	1.60
PSB1004680LZF	68.0 \pm 15%	1V / 100K	210	1.40
PSB1004820LZF	82.0 \pm 15%	1V / 100K	240	1.30
PSB1004101KZF	100.0 \pm 10%	1V / 100K	290	1.20
PSB1004121KZF	120.0 \pm 10%	1V / 100K	340	1.10
PSB1004151KZF	150.0 \pm 10%	1V / 100K	470	1.00
PSB1004181KZF	180.0 \pm 10%	1V / 100K	530	0.90
PSB1004221KZF	220.0 \pm 10%	1V / 100K	730	0.80
PSB1004271KZF	270.0 \pm 10%	1V / 100K	830	0.70
PSB1004331KZF	330.0 \pm 10%	1V / 100K	990	0.65
PSB1004391KZF	390.0 \pm 10%	1V / 100K	1100	0.60
PSB1004471KZF	470.0 \pm 10%	1V / 100K	1250	0.55
PSB1004561KZF	560.0 \pm 10%	1V / 100K	1600	0.50
PSB1004681KZF	680.0 \pm 10%	1V / 100K	1800	0.45
PSB1004821KZF	820.0 \pm 10%	1V / 100K	2060	0.40
PSB1004102KZF	1000.0 \pm 10%	1V / 100K	2800	0.38



RoHS Compliant

NOTE : Specifications subject to change without notice. Please check our website for latest information.

05.05.2008



SUPERWORLD ELECTRONICS (S) PTE LTD

PG. 2

7. CHARACTERISTICS CURVES :

@ TEMP. RISE VS. DC SUPERPOSITION RESPONSE CURVE

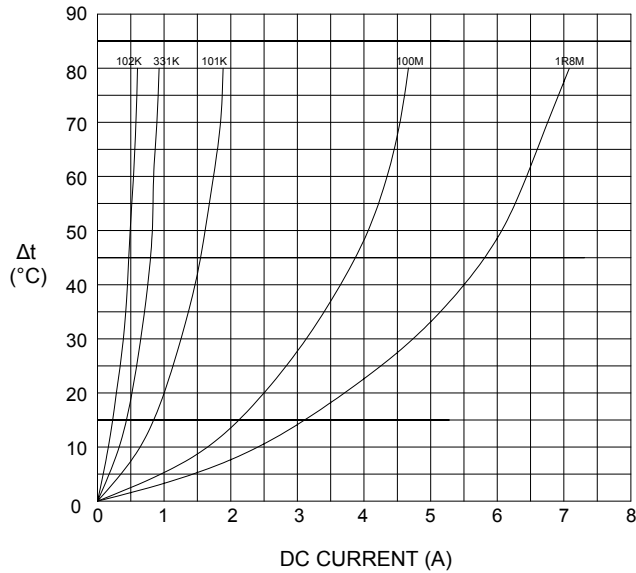

@ INDUCTANCE VS. FREQUENCY RESPONSE CURVE

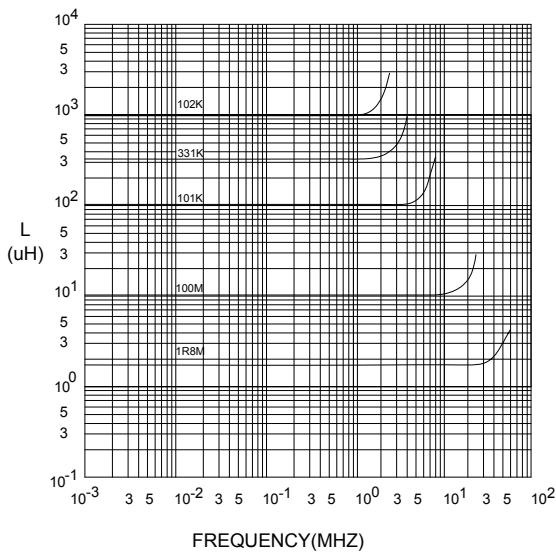

@ INDUCTANCE VS. DC SUPERPOSITION RESPONSE CURVE

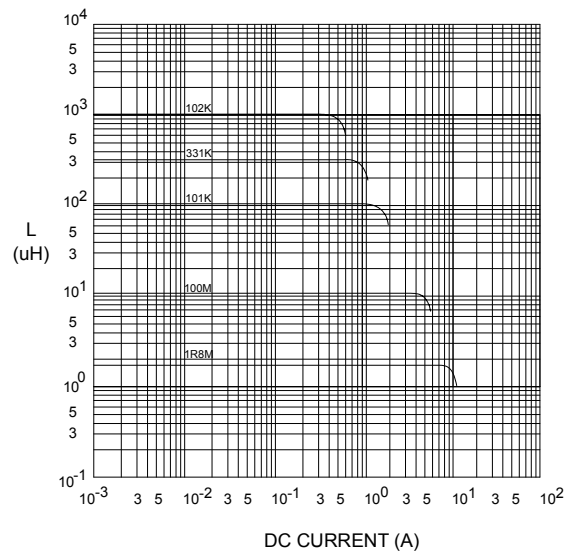

NOTE : Specifications subject to change without notice. Please check our website for latest information.



RoHS Compliant

05.05.2008



SUPERWORLD ELECTRONICS (S) PTE LTD

RECOMMENDED SOLDERING CONDITIONS REFLOW SOLDERINGS

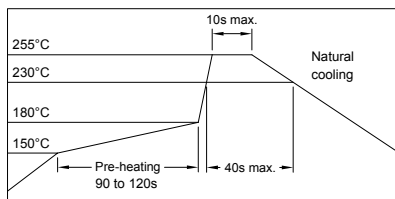

8. PACKAGING INFORMATION :

(1) CONFIGURATION

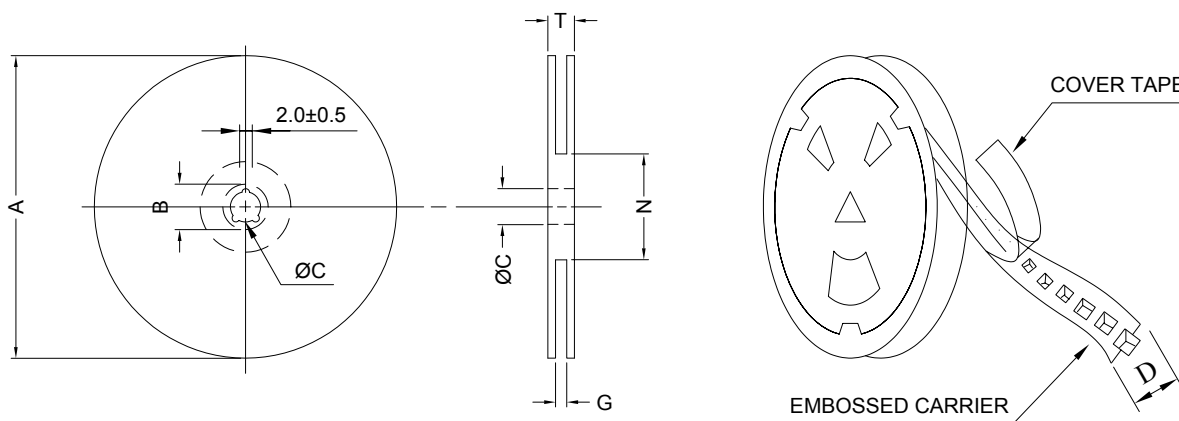

* CARRIER TAPE WIDTH : D

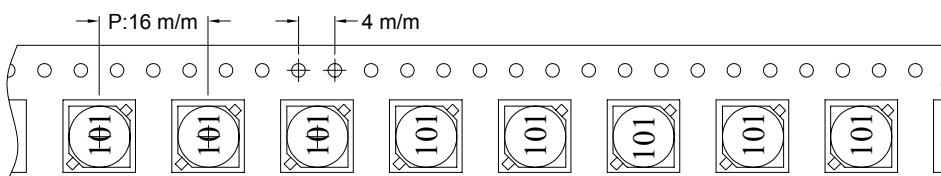

(2) DIMENSIONS

Unit:m/m

STYLE	A	B	C	D	G	N	T
13-24	330	21±0.8	13	24	26 ⁺⁰	50 ⁻⁰	30.4

(3) Q'TY & G.W. PER PACKAGE

SERIES	INNER : REEL			OUTER : CARTON		
	Q'TY (PCS)	G.W. (gw)	STYLE	Q'TY (PCS)	G.W. (Kg)	SIZE (cm)
PSB1004	600	900	13-24	2400	7.1	40 x 40 x 24



RoHS Compliant

NOTE : Specifications subject to change without notice. Please check our website for latest information.

05.05.2008

9. RELIABILITY AND TEST CONDITION :

TEST ITEM	SPECIFICATION	TEST CONDITION
SOLDERABILITY	MORE THAN 90% OF THE TERMINAL ELECTRODE SHALL BE COVERED WITH FRESH SOLDER.	PREHEAT : 125±25°C FOR 60 SECONDS SOLDER : 99%Sn/0.3%Ag/0.7%Cu OR EQUIVALENT SOLDER TEMP. : 245±5°C FLUX : ROSIN DIP TIME : 4±1 SECONDS
THERMAL SHOCK TEST (TEMP. CYCLE)	INDUCTANCE SHALL NOT CHANGE MORE THAN ±20%	ROOM TEMP. → -25±2°C 15 MINUTES 30 MINUTES ROOM TEMP. → 85±2°C 15 MINUTES 30 MINUTES TOTAL : 50 CYCLES
HUMIDITY RESISTANCE TEST		TEMPERATURE : 40±2°C HUMIDITY : 90 ~ 95% APPLIED CURRENT : PER SPEC. TIME : 500 HOURS
HIGH TEMP. RESISTANCE TEST		TEMPERATURE : 85±2°C APPLIED CURRENT : PER SPEC. TIME : 500 HOURS



RoHS Compliant

NOTE : Specifications subject to change without notice. Please check our website for latest information.

05.05.2008



SUPERWORLD ELECTRONICS (S) PTE LTD

10. UL CARD :

OBMW2 **November 30, 2000**
Magnet Wire - Component

PACIFIC ELECTRIC WIRE & CABLE (SHENZHEN) CO LTD **E201757**
607 BAOLONG INDUSTRIAL ESTATE LONGGANG, SHENZHEN
GUANGDONG CHINA

Mtl Dsg	Coating Type	TC	ANSI Type	TI
UEW/U	BC Polyurethane	—	—	130
PEW/U	Polyester	—	MW5-C	155°C
PEWH/U	Modified Polyester	—	MW30-C	180
PEW-NY/U	Polyester	Polyamide	MW24-C	155
HAI/U	Polyester(Amide)(Imide)	Polyamideimide	MW35,73	200
UEW-NY/U	Polyurethane	Polyamide	MW80-C	155
			MW28-C	130

Marking: Company name and material designation or marked designation on package or reel, and Recognized Component Mark.

See General Information Preceding These Recognitions

1/3/2001 **Underwriters Laboratories Inc.** **Card 1 of 2**

SUMITOMO CHEMICAL CO LTD **E54705 (M)**
5-33 KITAHAMA 4-CHOME CHUO-KO, OSAKA JAPAN

Mtl Dsg	Col	Min Thk mm	UL94 Flame Class	Elec	RTI		w/o Imp	H W I	H A I	H V T R	D 4 5	C T I
					with Imp	Mech						
Liquid crystal polyester (LCP), designated "EKONOL" or "SUMIKASUPER", furnished in the form of pellets, (Contd)												
E4008 , E400X	NC , BK	0.30	94V-0	130	130	130	—	—	—	—	—	—
		0.75	94V-0	130	130	130	3	4	—	—	—	—
		1.5	94V-0	130	130	130	2	4	—	—	—	—
		3.0	94V-0	130	130	130	1	4	0	5	4	—
E4008	NC , WT , BK	0.30	94V-0	130	130	130	—	—	—	—	—	—
		0.75	94V-0	220	180	220	3	4	—	—	—	—
		1.5	94V-0	220	200	240	2	4	—	—	—	—
		3.0	94V-0	220	200	240	1	4	0	5	4	—
E4010	NC , BK	0.30	94V-0	130	130	130	—	—	—	—	—	—
		0.75	94V-0	220	180	220	3	4	—	—	—	—
		1.5	94V-0	220	200	240	2	4	—	—	—	—
		3.0	94V-0	220	200	240	1	4	0	5	4	—
E400(Y)L , E4008L	NC , BK	0.30	94V-0	130	130	130	—	—	—	—	—	—
		0.75	94V-0	130	130	130	3	4	—	—	—	—
		1.5	94V-0	130	130	130	2	4	—	—	—	—
		3.0	94V-0	130	130	130	1	4	0	5	4	—
E4810	NC , BK	0.30	94V-0	130	130	130	—	—	—	—	—	—
		0.75	94V-0	130	130	130	0	4	—	—	—	—
		1.5	94V-0	130	130	130	0	4	—	—	—	—
		3.0	94V-0	130	130	130	1	4	0	5	4	—

(X) Denotes any number 1 thru 9.
(Y) Denotes any number 1 thru 7.



RoHS Compliant

NOTE : Specifications subject to change without notice. Please check our website for latest information.

05.05.2008



SUPERWORLD ELECTRONICS (S) PTE LTD