

**9 - 60 V**  
Continuous Input

**0 - 60 V**  
Outputs

**5.0 A**  
Current

**Non-Isolated**

**Eighth-brick**  
DC-DC Converter

The NiQor® eighth-brick dc-dc converter is a non-isolated digital buck-boost regulator, which employs synchronous rectification to achieve extremely high conversion efficiency. The High Input Voltage NiQor Brick family of converters can be used in traditional DPA (distributed power architecture) systems or provide a regulated output voltage from a battery source or other variable voltage source. The NiQor Brick family can be configured to Buck the input voltage down to a lower voltage or Boost the input voltage up to a higher voltage using a single external resistor. These modules are RoHS 6/6 compliant (see last page).

## NiQor®

Non-Isolated



*NiQor eighth-brick module*

### Operational Features

- Ultra high efficiency, up to 96% at full rated load
- Delivers up to 5 A of output current with minimal derating - no heatsink required
- Input Voltage Range: 9 - 60 V
- Output voltage range: 0 - 60 V (negative output is possible)
- Extensive on-board input and output filtering
- No minimum load requirement means no preload resistors required
- Buck or buck-boost mode available
- Adjustable current limit with current monitor (C option)

### Mechanical Features

- Industry standard eighth-brick pin-out configuration
- Size: 0.99" x 2.39" (25x60.6 mm)
- Total height only 0.50" (12.7 mm)
- Total weight: 1.7 oz (48 grams)

### Control Features

- On/Off control
- Output voltage trim permits custom voltages
- Remote Sense (S option, standard)
- Current limit trim (C option)

### Protection Features

- Input under-voltage lockout protects the converter at low input voltage conditions
- Over-current shutdown protects converter from excessive load current or short circuits
- Input/output over-voltage protection protects load and regulator from damaging voltages
- Thermal shutdown protects converter from abnormal environmental conditions

### Safety Features

- UL/cUL 60950-1 recognized (US & Canada)
- TUV certified to EN60950-1
- Board and plastic components meet UL94V-0 flammability requirements

**Input:** 9 - 60 V  
**Outputs:** 0 - 60 V  
**Current:** 5 A  
**Package:** Eighth-brick

### MECHANICAL DIAGRAM

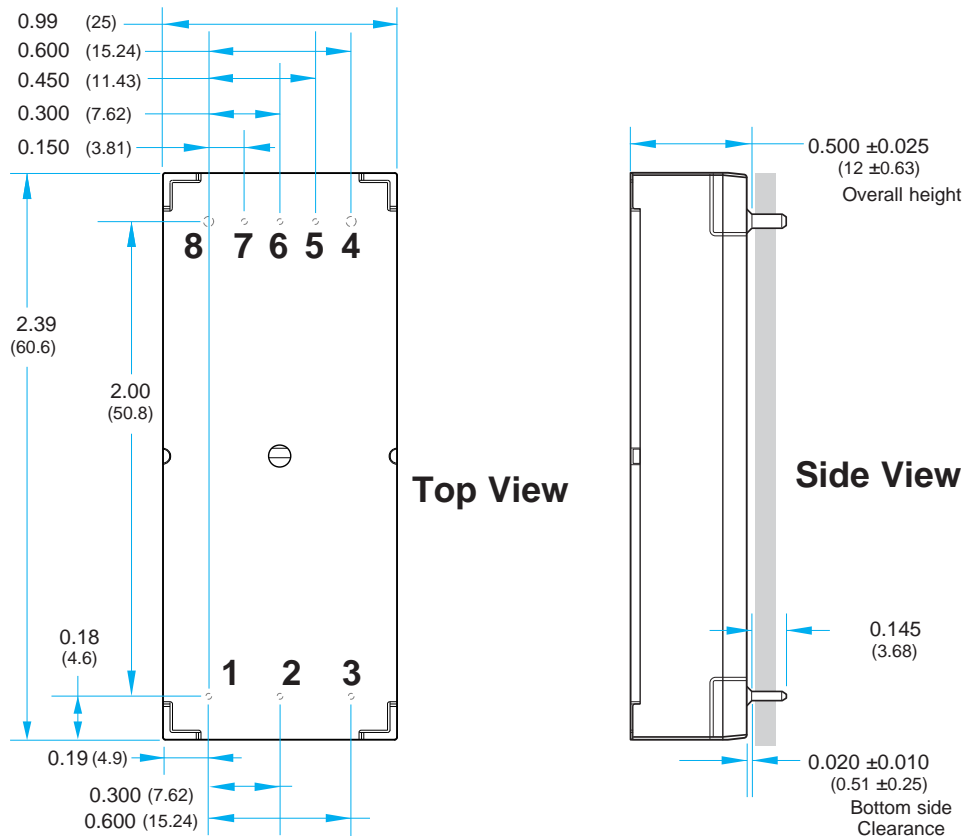

### NOTES

- 1) Pins 1-3, 5-7 are 0.040" (1.02 mm) diameter, with 0.080" (2.03mm) diameter standoff shoulders.
- 2) Pins 4 and 8 are 0.062" (1.57 mm) diameter with 0.100" (2.54 mm) diameter standoff shoulders.
- 3) Other pin extension lengths available. Recommended pin length is 0.03" (0.76 mm) greater than the PCB thickness.
- 4) All Pins: Material - Copper Alloy  
Finish - Matte Tin over Nickel plate
- 5) Undimensioned components are shown for visual reference only.
- 6) All dimensions in inches (mm)  
Tolerances: x.xx ±0.02" (x.x ±0.5 mm)  
x.xxx ±0.010" (x.xx ±0.25 mm)
- 7) Weight: 1.7 oz (48 g) typical
- 8) Workmanship: Meets or exceeds IPC-A-610C Class II

### PIN DESIGNATIONS

Pin No.	Name	Function
1	Vin(+)	Positive input voltage
2	ON/OFF	TTL input to turn converter on and off, referenced to Vin(-), with internal pull up
3	Vin(-)	Negative input voltage, internal short to Pin 4
4	Vout(-)	Negative output voltage, internal short to Pin 3
5	SENSE(-)	Negative remote sense <sup>1</sup> (S option)
	ITRIM	Current limit trim (C option)
6	VTRIM	Output voltage trim
	SENSE(+)	Positive remote sense <sup>2</sup> (S option)
7	IMON	Current monitor output (C option)
	Vout(+)	Positive output voltage

#### Notes:

1. SENSE(-) should be connected to Vout(-) either remotely or at the converter.
2. SENSE(+) should be connected to Vout(+) either remotely or at the converter.

## NQ60x60EGC05 ELECTRICAL CHARACTERISTICS

Ta = 25 °C, airflow rate = 300 LFM, Vin = 24 V dc unless otherwise noted; full operating temperature range is -40 °C to +105 °C ambient temperature with appropriate power derating. Specifications subject to change without notice.

Parameter	Vout	Min.	Typ.	Max.	Units	Notes & Conditions
<b>ABSOLUTE MAXIMUM RATINGS</b>						
Input Voltage						
Non-Operating	All	0		80	V	Continuous
Operating	All			60	V	Continuous
Storage Temperature	All	-55		125	°C	
Voltage at ON/OFF input pin	All	0		5.5	V	
<b>RECOMMENDED OPERATING CONDITIONS</b>						
Input Voltage Range	All	9		60	V	Turn on at 10V
Input Fuse Rating	All			8	A	Fast blow external fuse recommended
Input Current				5	A	Input current max equals output rated current
External Input Capacitance	All	100			µF	ESR < 1.5Ω
Output Voltage	All	0		60	V	
Output Current	All	0		5	A	Output voltage dependent
<b>INPUT CHARACTERISTICS</b>						
Input Under-Voltage Lockout						
Turn-On Voltage Threshold	All	9.2	9.5	10	V	
Turn-Off Voltage Threshold	All	8.1	8.5	8.9	V	
Lockout Hysteresis	All		1.0		V	
Input Current Limit	All		6		A	
No-Load Input Current	12		65		mA	
"	24		76		mA	
"	48		100		mA	
Disabled Input Current	All		30		mA	
Input Filter Components Value (C/L/C)	All		2.2 1.5 8.8		µF µH µF	
<b>OUTPUT CHARACTERISTICS</b>						
Output Voltage Range	All	0		60	V	Set output by Rtrim resistor
Operating Output Current Range	All	0		5	A	
Output Voltage Regulation						
Total Output Voltage Range	All		±480 mV ±4%*Vout			Sense pin, over sample, line, load, temp. & life
Output Voltage Ripple and Noise (pk-pk/36Vin)	12		20		mV	36 Vin Full Load; 100µF; 20 MHz b.w.
"	24		20		mV	
"	48		100		mV	
Output DC Over Current limit	All		6		A	Effective on input, output condition
External Output Capacitance	All	0		1000	µF	ESR > 1 mΩ
C Option: Isense voltage						
No load	All		1.25		V	
Full load	All		1.54		V	5 A load
Output resistance of Isense	All		10		kΩ	
C Option: Itrim voltage						
Voltage at no load	All		0.12		V	
Voltage at maximum load	All		2.12		V	5 A load
Pull-Up Resistance of Itrim Pin	All		10.2		kΩ	
Pull-Up Voltage	All		2.5		V	
C Option: Reverse Current	All			2	µA	Enabled or Disabled
<b>TEMP LIMITS FOR POWER DERATING</b>						
Semiconductor Junction Temperature	All			125	°C	Package rated to 150 °C
Board Temperature	All			125	°C	ULrated max operating temp 130 °C
Baseplate Temperature	All			100	°C	
<b>EFFICIENCY</b>						
100% Load; 24 Vin	12		93		%	
" ; 48 Vin	24		95		%	
" ; 24 Vin	48		95		%	W mode only
50% Load; 24 Vin	12		95		%	
" ; 48 Vin	24		97		%	
" ; 24 Vin	48		95		%	W mode only





# Technical Specification

**Input:** 9 - 60 V  
**Outputs:** 0 - 60 V  
**Current:** 5 A  
**Package:** Eighth-brick

## NQ60x60EGC05 ELECTRICAL CHARACTERISTICS (Continued)

Ta = 25 °C, airflow rate = 300 LFM, Vin = 24 V dc unless otherwise noted; full operating temperature range is -40 °C to +105 °C ambient temperature with appropriate power derating. Specifications subject to change without notice.

Parameter	Vout	Min.	Typ.	Max.	Units	Notes & Conditions
<b>DYNAMIC CHARACTERISTICS</b>						
Output Voltage during Current Transient						
For a Step Change in Output Current	All		1		V	(0.1 A/μs); 50%-75%-50% Iout max
Settling Time	All		5		ms	To within 1.5% Vout nom.
Turn on Transient						
Startup delay	All		2		ms	Resistive load
Rise Rate	All		0.6		V/ms	"
Output Voltage Overshoot	All			0	V	"
<b>FEATURE CHARACTERISTICS</b>						
Switching Frequency	All	240	250	260	kHz	
ON/OFF Control						
Negative Logic (N) ON/OFF Control						
Off-State Voltage	All	1.8		3	V	
On-State Voltage	All	0		0.8	V	
Pull-Up Voltage	All		3.3		V	
Pull-Up Resistance	All		10		kΩ	
Output Voltage Trim Range	All	0		60	V	Measured Vout+ to common pins
Input/Output Over-Voltage Protection	All	66	72	75	V	Over full temp range
Over-Temperature Shutdown	All		115		°C	Average PCB Temperature
Over-Temperature Shutdown Restart Hysteresis	All		15		°C	
<b>RELIABILITY CHARACTERISTICS</b>						
Calculated MTBF (TR-NWT-000332; Telcordia)	All		TBD		10 <sup>6</sup> Hrs.	100% load, 200LFM, 40 °C Ta
Calculated MTBF (MIL-HDBK-217F; MIL-217)	All		TBD		10 <sup>6</sup> Hrs.	100% load, 200LFM, 40 °C Ta
Field Demonstrated MTBF	All				10 <sup>6</sup> Hrs.	See our website for details

## STANDARDS COMPLIANCE

Parameter	Notes & Conditions
<b>STANDARDS COMPLIANCE</b>	
UL/cUL 60950-1	Pending UL Approval File # E194341
EN60950-1	Certified by TUV
Needle Flame Test (IEC 695-2-2)	Test on entire assembly; board & plastic components UL94V-0 compliant
IEC 61000-4-2	ESD test, 8 kV - NP, 15 kV air - NP (Normal Performance)
GR-1089-CORE	Section 7 - electrical safety, Section 9 - bonding/grounding
Telcordia (Bellcore) GR-513	

Note: An external input fuse must always be used to meet these safety requirements. Contact SynQor for official safety certificates on new releases or download from the SynQor website.

## QUALIFICATION TESTING

Parameter	# Units	Test Conditions
<b>QUALIFICATION TESTING</b>		
Life Test	32	95% rated Vin and load, units at derating point, 1000 hours
Vibration	5	10-55 Hz sweep, 0.060" total excursion, 1 min./sweep, 120 sweeps for 3 axis
Mechanical Shock	5	100g minimum, 2 drops in x and y axis, 1 drop in z axis
Temperature Cycling	10	-40 °C to 100 °C, unit temp. ramp 15 °C/min., 500 cycles
Power/Thermal Cycling	5	Toperating = min to max, Vin = min to max, full load, 100 cycles
Design Marginality	5	Tmin-10 °C to Tmax+10 °C, 5 °C steps, Vin = min to max, 0-105% load
Humidity	5	85 °C, 85% RH, 1000 hours, continuous Vin applied except 5 min/day
Solderability	15 pins	MIL-STD-883, method 2003

Note: Extensive characterization testing of all SynQor products and manufacturing processes is performed to ensure that we supply robust, reliable product. Contact the factory for official product family qualification documents.

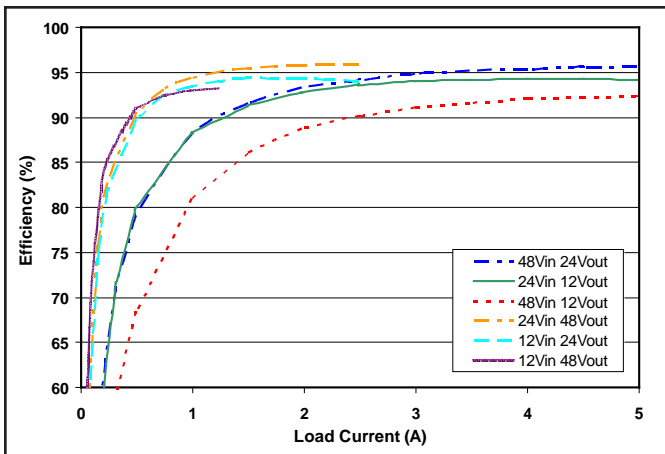

Figure 1: Efficiency at different output voltage vs. load current for different input voltage at 25 °C.

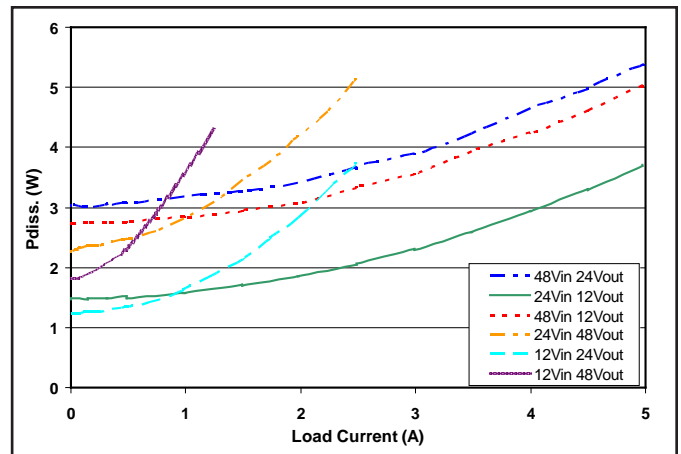

Figure 2: Power dissipation at different output voltage vs. load current for different input voltage at 25 °C.

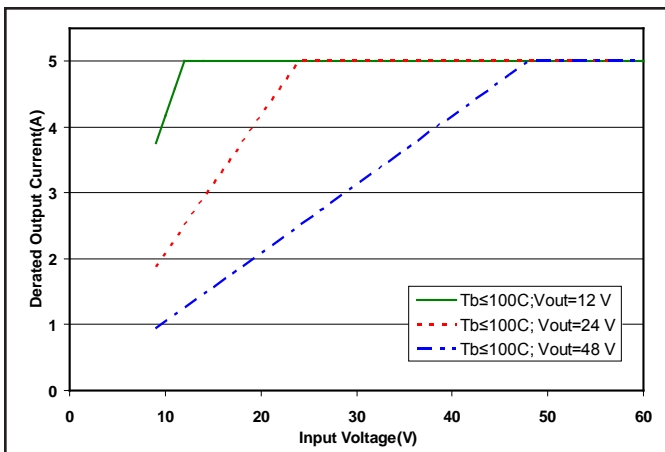

Figure 3: Maximum output power derating curve with a controlled baseplate temperature of 80°C and 100°C.

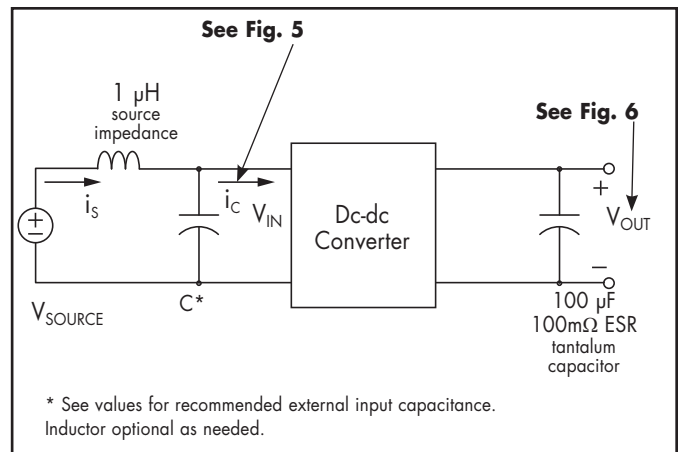

Figure 4: Test set-up diagram showing measurement points for Input Terminal Ripple Voltage (Figure 5), and Output Voltage Ripple (Figure 6).

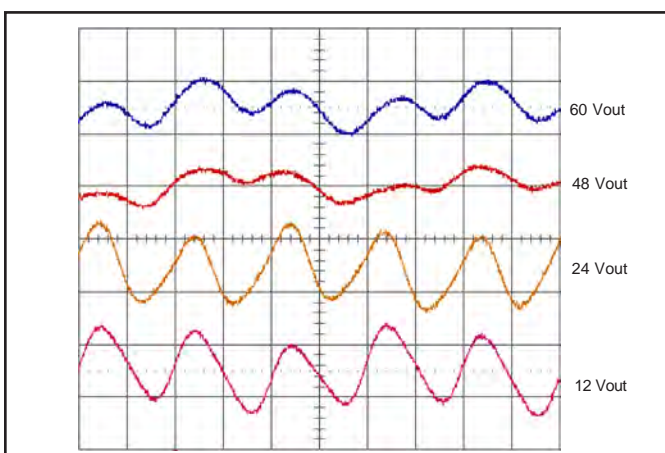

Figure 5: Input Terminal Ripple Voltage at 24 V input voltage and rated load current (500 mA/div). Bandwidth: 20 MHz. See Figure 4.

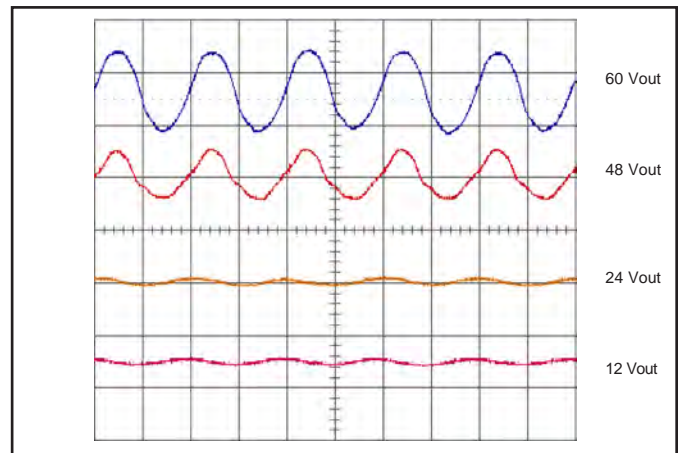
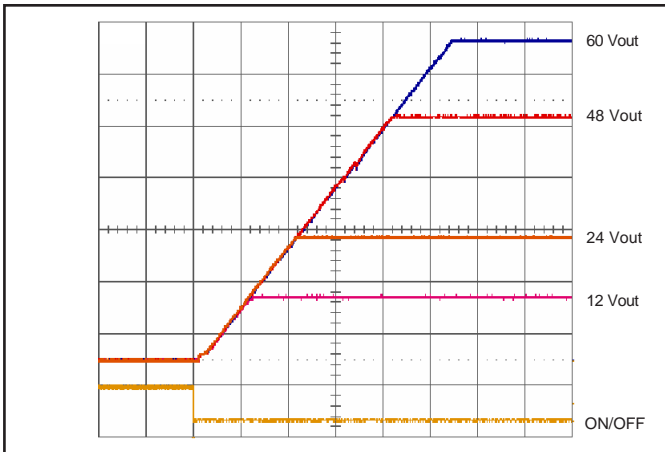
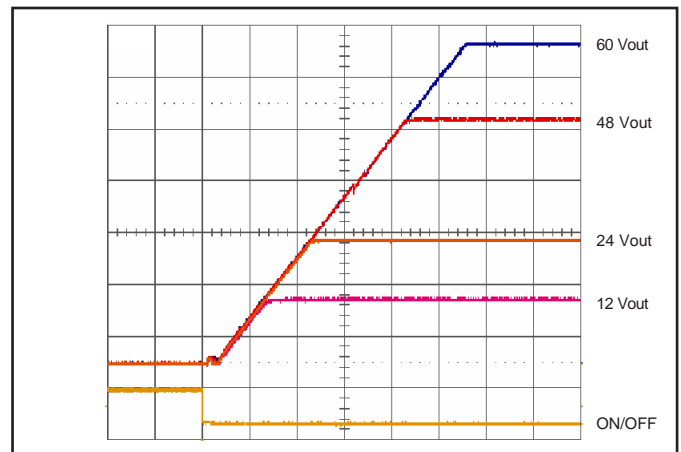

Figure 6: Output Voltage Ripple at 36 V input voltage and rated load current (100 mV/div). Zero load capacitance. Bandwidth: 20 MHz. See Figure 4.



**Figure 7:** Turn-on transient at zero load (20 ms/div).  
 Ch 1: ON/OFF input (5 V/div)  
 Ch 2-4: Vout (10 V/div)



**Figure 8:** Turn-on transient at full load (20 ms/div).  
 Ch 1: ON/OFF input (5 V/div)  
 Ch 2-4: Vout (10 V/div)(100mV/div).

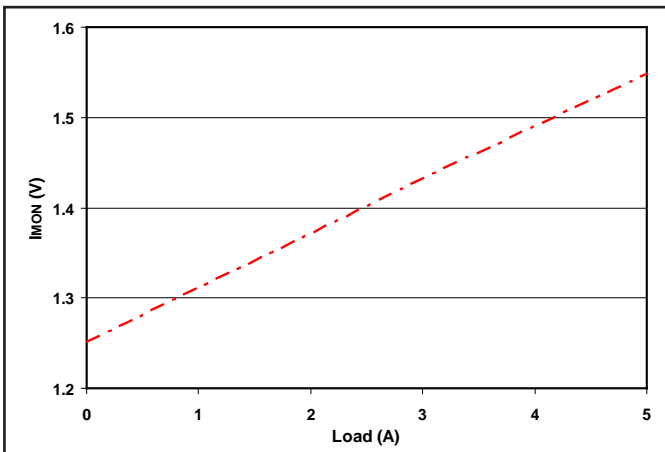

**Figure 9:**  $I_{MON}$  pin voltage vs. load current at 24 V input and 13.8 V output. Load capacitance: 100 $\mu$ F electrolytic cap. C option only.

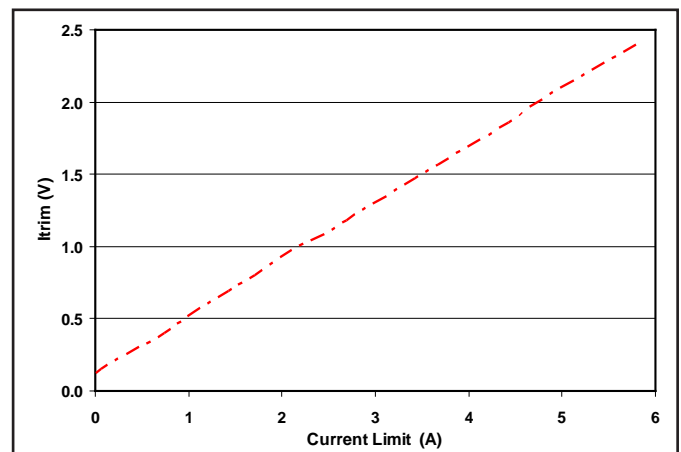

**Figure 10:** Current limit vs.  $I_{trim}$  pin voltage with 24 V input and 13.8 V output. Load capacitance: 100 $\mu$ F electrolytic cap. C option only.

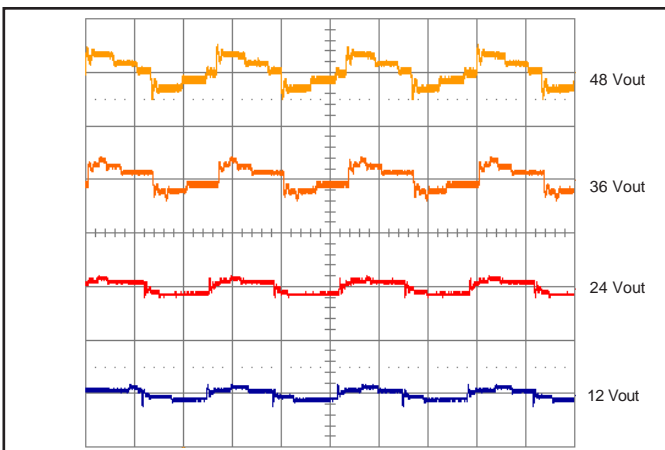

**Figure 11:** Output voltage response for 12 V, 24 V, 36 V, and 48 Vout to step-change in load current (50-75-50% of  $I_{out}$  max;  $di/dt=0.1A/\mu s$ ). Load cap: 100 $\mu$ F, 100m $\Omega$  ESR tant, Vout (2 V/div).



### BASIC OPERATION AND FEATURES

These converters use a digital controller for the buck stage and boost stage (see Figure A). It automatically changes operating mode (buck mode or boost) when the line voltage or output set point changes. Both stages are accomplished with synchronous rectifiers. Very high efficiency is maintained over wide input and output ranges by shifting operational modes and use of synchronous rectifiers.

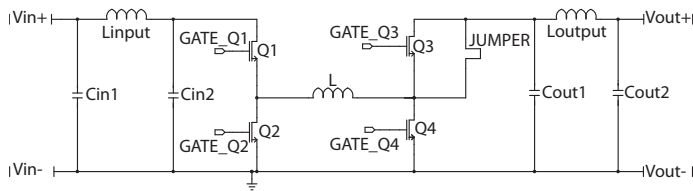

Figure A: Topology

W mode: Q3, Q4 are populated, Jumper is open.

T mode: Q3, Q4 are open, Jumper is populated.

The converter runs at a fixed frequency with a predictable EMI performance.

This series of quarter-brick and eighth-brick converters use the industry standard footprint and pin-out configuration.

### CONTROL FEATURES

**REMOTE ON/OFF:** The ON/OFF input permits the user to control when the converter is on or off. Only Negative ON/OFF logic is available in this power module series.

Negative logic ON/OFF signal turns the module OFF during logic high (leave the pin floating or set voltage between 1.8~3.3 V) and turns the module ON during logic low [tie to Vin(-)].

**OUTPUT VOLTAGE TRIM:** The output voltage can be programmed to any voltage between 0 V dc and V<sub>max</sub> by connecting one resistor between the Pin 6 (TRIM) pin and Pin 5 [Sense(-)]. For a desired output voltage, the value of the resistor should be:

$$R_{\text{trim-up}}(V_{\text{out}}) = \left[ \left( \frac{11736 \times V_{\text{max}}}{V_{\text{out}} + .0536 \times V_{\text{max}}} \right) - 10912 \right] (\Omega)$$

Alternatively, the TRIM pin can be driven from an external voltage source:

$$V(\text{pin6}) = 2.366 - 2.316 \left( \frac{V_{\text{out}}}{V_{\text{max}}} \right)$$

where:

V<sub>out</sub> = desired output voltage

V<sub>max</sub> = maximum rated output voltage

To maintain the accuracy of the output voltage over load current, it is vital that any trim-up resistor be terminated directly to the converter's Sense(-) pin (S option) or Vout(-) pin (C option), not at the connection to the load. A separate Kelvin connection to the PCB pad for the Vout(-) is optimal.

### PROTECTION FEATURES

**Input Under-Voltage Lockout:** The converter is designed to turn off when the input voltage is too low, helping avoid an input system instability problem, described in more detail in the application note titled "Input System Instability". The lockout circuitry is a comparator with DC hysteresis. When the input voltage is rising, it must exceed the typical Turn-On Voltage Threshold value (listed on the specification page) before the converter will turn on. Once the converter is on, the input voltage must fall below the typical Turn-Off Voltage Threshold value before the converter will turn off.

**Output Current Shutdown:** To provide protection in an output short condition, the unit is equipped with internal short circuit protection. When the short protection is triggered, the unit shutdowns first. After approximately 16 ms inhibit time, the units turn on again. If the short condition remains, the current limit circuit will limit the output current. The units operate normally once the fault condition is removed.

**Internal Over-Voltage Protection:** To fully protect from excessive output voltage, the output over-voltage shutdown circuitry is contained. This OVP is independent of the trimmed set point. The shutdown point is fixed on the standard option.

**Over-Temperature Shutdown:** A temperature sensor on the converter senses the average temperature of the module. The thermal shutdown circuit is designed to turn the converter off when the temperature at the sensed location reaches the Over-Temperature Shutdown value. It will allow the converter to turn on again when the temperature of the sensed location falls by the amount of the Over-Temperature Shutdown Restart Hysteresis value.

### APPLICATION CONSIDERATIONS

**Limited output voltage resolution:** The internal voltage control feedback loop has limited resolution. Therefore, the output voltage will exhibit discrete steps as the loop responds to changes in line, load, trim, or remote sense. For instance, on close examination, the startup ramp has a "stair-step" shape. Likewise, a load transient response will be composed of multiple discrete steps.

**Input filtering:** These modules should be connected to a low-impedance source. A highly inductive source can affect the stability of the module. An input capacitance must be placed directly adjacent to the input pin of the module, to minimize input ripple voltage and ensure module stability.

**Output capacitance:** For stable operation of the module, there is no extra external capacitor required. To reduce the output ripple and improve dynamic response to a step load change, additional capacitance at the output can be used. Low ESR polymer and ceramic capacitors are recommended to improve the dynamic response of the module. In many applications, however, additional external output capacitance is a requirement which will cause the startup time to change.

**Remote sense (S option):** Vout remote sensing is provided to achieve proper regulation at the load points and reduce effects of distribution losses on output line. In the event of an open remote sense line, the module shall maintain local sense regulation through an internal resistor. The module shall correct for a total of 10% Vout.

**Current limit:** Available power is limited by output current in buck mode ( $V_{in} > V_{out}$ ), but by input current in boost mode ( $V_{in} < V_{out}$ ).

$$\text{for } V_{in} > V_{out}, \\ I_{limit} = 1.2 \times I_{max}$$

$$\text{for } V_{in} \leq V_{out}, \\ I_{limit} = 1.2 \times I_{max} \left( \frac{V_{in}}{V_{out}} \right)$$

where  $I_{max}$  = Maximum rated output current

**Negative output:** This series of converters can be set to negative output (see Figure B).

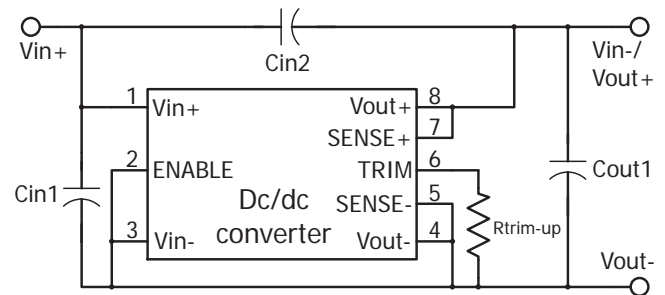

Figure B: Negative output setup

Using this negative output setup impacts the available output voltage range and current limit.

The output voltage range becomes 0 to  $V_{max} - V_{in}$ , and the current limit is scaled by:

$$\frac{V_{in}}{(V_{in} + V_{out})}$$

**Current monitor/trimmable current limit (C option):** In addition to voltage trim, the C option offers an adjustable current limit input and a current monitor output. The C option also includes an ideal diode circuit in series with the Vout+ pin that prevents reverse current flow. This enables applications such as battery charging, current sharing, and current read back.

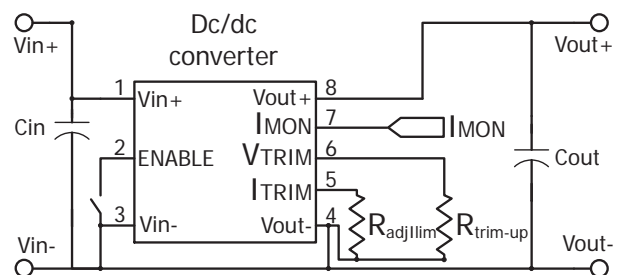

Figure C: Current monitor/trimmable current limit setup

The  $R_{trim-up}$  resistor increases the output voltage, identical in function to the S option.

The  $R_{adjItrim}$  resistor reduces the output current limit, according to the following equation:

$$R_{adjItrim} = \left[ \left( \frac{0.0469 I_{max} + I_{trim}}{1.153 I_{max} + I_{trim}} \right) 10200 - 10 \right] (\Omega)$$

Alternatively, the  $I_{trim}$  pin can be driven from an external voltage source:

$$V(\text{pin5}) = 2.085(I_{trim}/I_{max}) + 0.0953$$

where  $I_{trim}$  is the desired current limit setpoint

If  $I_{limit}$  is less than  $I_{trim}$ , then  $I_{limit}$  takes precedence.

The  $I_{mon}$  pin voltage tracks the output current, as shown in figure 10. This pin has a 10kOhm output impedance.





# Technical Specification

**Input:** 9 - 60 V  
**Outputs:** 0 - 60 V  
**Current:** 5 A  
**Package:** Eighth-brick

## PART NUMBERING SYSTEM

The part numbering system for SynQor's dc-dc converters follows the format shown in the example below.

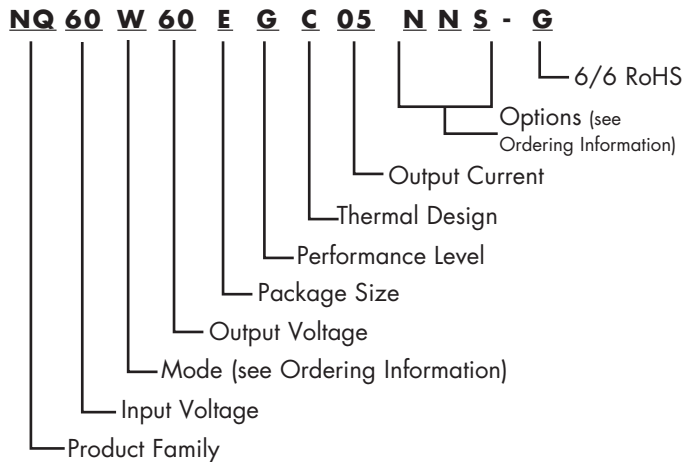

The first 12 characters comprise the base part number and the last 3 characters indicate available options. The "-G" suffix indicates 6/6 RoHS compliance.

## Application Notes

A variety of application notes and technical white papers can be downloaded in pdf format from our website.

**RoHS Compliance:** The EU led RoHS (Restriction of Hazardous Substances) Directive bans the use of Lead, Cadmium, Hexavalent Chromium, Mercury, Polybrominated Biphenyls (PBB), and Polybrominated Diphenyl Ether (PBDE) in Electrical and Electronic Equipment. This SynQor product is 6/6 RoHS compliant. For more information please refer to SynQor's RoHS addendum available at our [RoHS Compliance / Lead Free Initiative web page](#) or e-mail us at rohs@synqor.com.

### Contact SynQor for further information:

**Phone:** 978-849-0600  
**Toll Free:** 888-567-9596  
**Fax:** 978-849-0602  
**E-mail:** power@synqor.com  
**Web:** [www.synqor.com](http://www.synqor.com)  
**Address:** 155 Swanson Road  
 Boxborough, MA 01719  
 USA

## ORDERING INFORMATION

The tables below show the valid model numbers and ordering options for converters in this product family. When ordering SynQor converters, please ensure that you use the complete 15 character part number consisting of the 12 character base part number and the additional 3 characters for options. Add "-G" to the model number for 6/6 RoHS compliance.

Model Number	Input Voltage	Output Voltage	Max Output Current
NQ60w60EGC05xyz-G	9 - 60 V	0 - 60 V	5 A

The following options must be included in place of the **xyz** spaces in the model numbers listed above.

Mode: w	Options Description: xyz		
	Enable Logic	Pin Style	Feature Set
T - Buck W - Buck / Boost	N - Negative	K - 0.110" N - 0.145" R - 0.180" Y - 0.250"	S - Standard C - Current monitor output / Trimmable current limit

Contact SynQor for C - Feature Set availability.

Not all combinations make valid part numbers, please contact SynQor for availability. See the [Product Summary web page](#) for more options.

## PATENTS

SynQor holds the following patents, one or more of which might apply to this product:

5,999,417	6,222,742	6,545,890	6,577,109
6,594,159	6,731,520	6,894,468	6,896,526
6,927,987	7,050,309	7,072,190	7,085,146
7,119,524	7,269,034	7,272,021	7,272,023

### Warranty

SynQor offers a three (3) year limited warranty. Complete warranty information is listed on our website or is available upon request from SynQor.

Information furnished by SynQor is believed to be accurate and reliable. However, no responsibility is assumed by SynQor for its use, nor for any infringements of patents or other rights of third parties which may result from its use. No license is granted by implication or otherwise under any patent or patent rights of SynQor.