

Surface Mount Zener Diode

MMSZ52XXB Series

A suffix of "-C" specifies halogen & lead-free

500mW,5% SOD-123

Electrical Characteristics @ $T_A=25^\circ\text{C}$ unless otherwise specified

Type Number	Marking Code	Zener Voltage Range (Note 1)				Maximum Zener Impedance (Note 3)		Maximum Reverse Leakage Current (Note 1)	
		$V_Z @ I_{ZT}$			I_{ZT}	$Z_{ZT}@I_{ZT}$	$V_{ZK} @ I_{ZK} = 0.25\text{mA}$	$I_R @ V_R$	
		Nom	Min	Max				μA	V
		V	V	V	mA	Ω			
MMSZ5221B	C1, C1	2.4	2.28	2.52	20	30	1200	100	1.0
MMSZ5222B	C2, C2	2.5	2.38	2.63	20	30	1250	100	1.0
MMSZ5223B	C3, C3	2.7	2.57	2.84	20	30	1300	75	1.0
MMSZ5225B	C5, C5	3.0	2.85	3.15	20	30	1600	50	1.0
MMSZ5226B	G1, G1, D1	3.3	3.14	3.47	20	28	1600	25	1.0
MMSZ5227B	G2, G2, D2	3.6	3.42	3.78	20	24	1700	15	1.0
MMSZ5228B	G3, G3, D3	3.9	3.71	4.10	20	23	1900	10	1.0
MMSZ5229B	G4, G4, D4	4.3	4.09	4.52	20	22	2000	5.0	1.0
MMSZ5230B	G5, G5, D5	4.7	4.47	4.94	20	19	1900	5.0	2.0
MMSZ5231B	E1, E1	5.1	4.85	5.36	20	17	1600	5.0	2.0
MMSZ5232B	E2, E2	5.6	5.32	5.88	20	11	1600	5.0	3.0
MMSZ5233B	E3, E3	6.0	5.70	6.30	20	7	1600	5.0	3.5
MMSZ5234B	E4, E4	6.2	5.89	6.51	20	7	1000	5.0	4.0
MMSZ5235B	E5, E5	6.8	6.46	7.14	20	5	750	3.0	5.0
MMSZ5236B	F1, F1	7.5	7.13	7.88	20	6	500	3.0	6.0
MMSZ5237B	F2, F2	8.2	7.79	8.61	20	8	500	3.0	6.5
MMSZ5238B	F3, F3	8.7	8.27	9.14	20	8	600	3.0	6.5
MMSZ5239B	F4, F4	9.1	8.65	9.56	20	10	600	3.0	7.0
MMSZ5240B	F5, F5	10	9.50	10.50	20	17	600	3.0	8.0
MMSZ5241B	H1, H1	11	10.45	11.55	20	22	600	2.0	8.4
MMSZ5242B	H2, H2	12	11.40	12.60	20	30	600	1.0	9.1
MMSZ5243B	H3, H3	13	12.35	13.65	9.5	13	600	0.5	9.9
MMSZ5245B	H5, H5	15	14.25	15.75	8.5	16	600	0.1	11
MMSZ5246B	J1, J1	16	15.20	16.80	7.8	17	600	0.1	12
MMSZ5248B	J3, J3	18	17.10	18.90	7.0	21	600	0.1	14
MMSZ5250B	J5, J5	20	19.00	21.00	6.2	25	600	0.1	15
MMSZ5251B	K1, K1	22	20.90	23.10	5.6	29	600	0.1	17
MMSZ5252B	K2, K2	24	22.80	25.20	5.2	33	600	0.1	18
MMSZ5254B	K4, K4	27	25.65	28.35	5.0	41	600	0.1	21
MMSZ5255B	K5, K5	28	26.60	29.40	4.5	44	600	0.1	21
MMSZ5256B	M1, M1	30	28.50	31.50	4.2	49	600	0.1	23
MMSZ5257B	M2, M2	33	31.35	34.65	3.8	58	700	0.1	25
MMSZ5258B	M3, M3	36	34.20	37.80	3.4	70	700	0.1	27
MMSZ5259B	M4, M4	39	37.05	40.95	3.2	80	800	0.1	30

Notes:

1. Short duration test pulse used to minimize self-heating effect.
2. Device mount on ceramic PCB; 7.6 mm x 9.4 mm x 0.87 mm with pad areas 25 mm².
3. f = 1 kHz

• Maximum Ratings @ $T_A=25^\circ\text{C}$ unless otherwise specified

Characteristic	Symbol	Value	Unit
Forward Voltage (Note 1) @ $I_F = 10\text{ mA}$	V_F	0.9	V
Power Dissipation (Note 2)	P_d	500	mW
Thermal Resistance, Junction to Ambient Air (Note 2)	$R_{\theta JA}$	350	$^\circ\text{C} / \text{W}$
Operating and Storage Temperature Range	T_J, T_{STG}	-65 ~ +150	$^\circ\text{C}$

Notes:

1. Short duration test pulse used in minimizes self-heating effect.
2. Device mount on ceramic PCB; 7.6 mm x 9.4 mm x 0.87 mm with pad areas 25 mm².

Features

- RoHS Compliant
- Planar Die Construction
- General Purpose Dissipation
- Ideally suited for Automated Assembly Process

Mechanical Data

- Case: SOD-123, Plastic
- Case material – UL Flammability Rating Classification 94V-0
- Moisture sensitivity: Level 1 per J-STD-020A
- Terminals: Solderable per MIL-STD-202, Method 208
- Polarity: Cathode Band
- Weight: 0.01 grams (approx.)

Outline

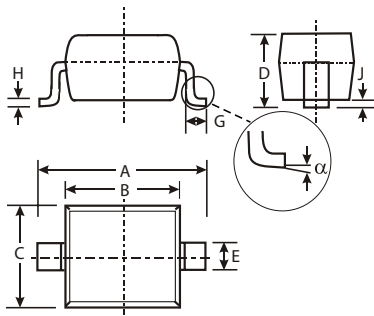

SOD-123		
Dim	Min	Max
A	3.55	3.85
B	2.55	2.85
C	1.40	1.70
D	-	1.35
E	0.55 Typical	
G	0.25	-
H	0.11 Typical	
J	-	0.10
α	0°	8°
All Dimensions in mm		

● Electrical Characteristic Curves @ T_A=25°C

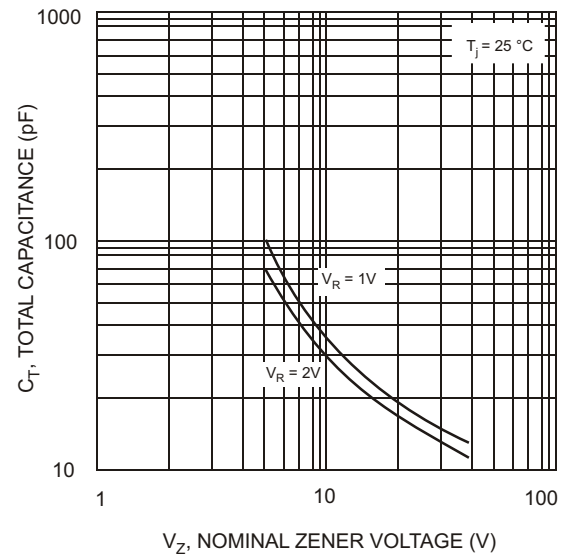
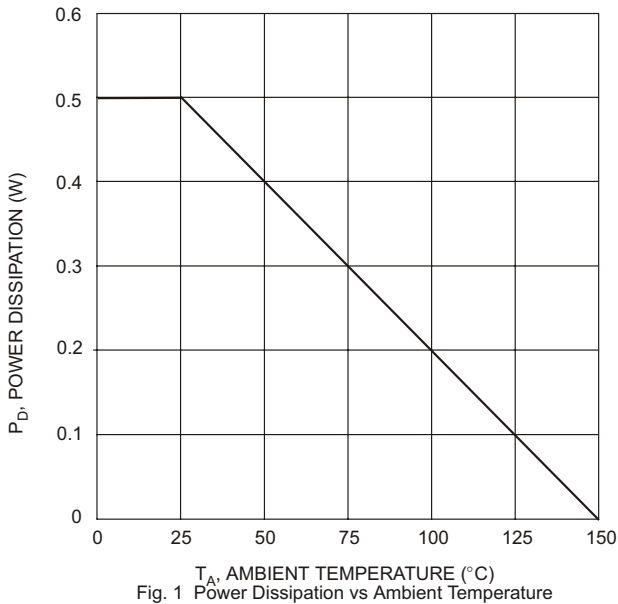

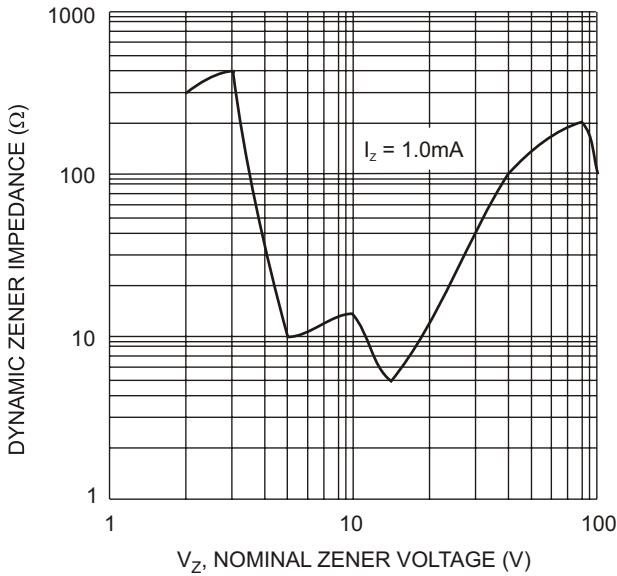

Fig. 3 Zener Voltage vs. Zener Impedence

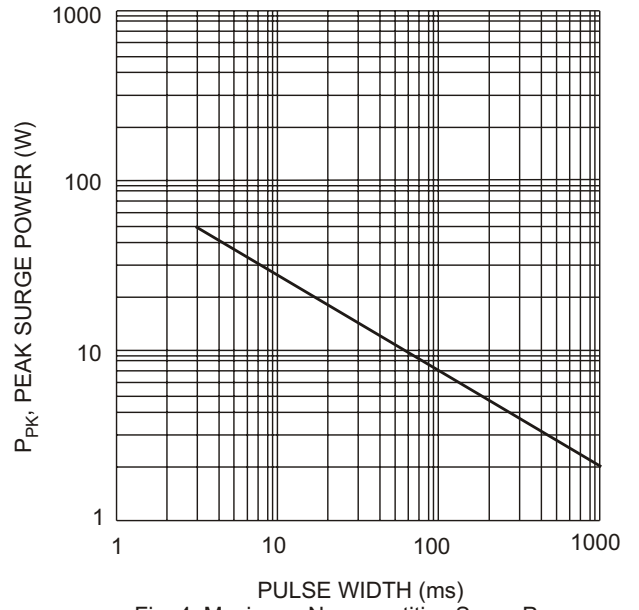

Fig. 4 Maximum Non-repetitive Surge Power

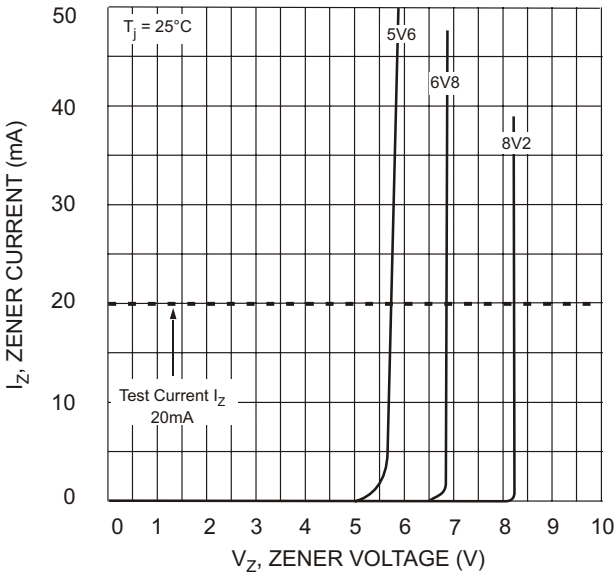

Fig. 5 Zener Breakdown Characteristics

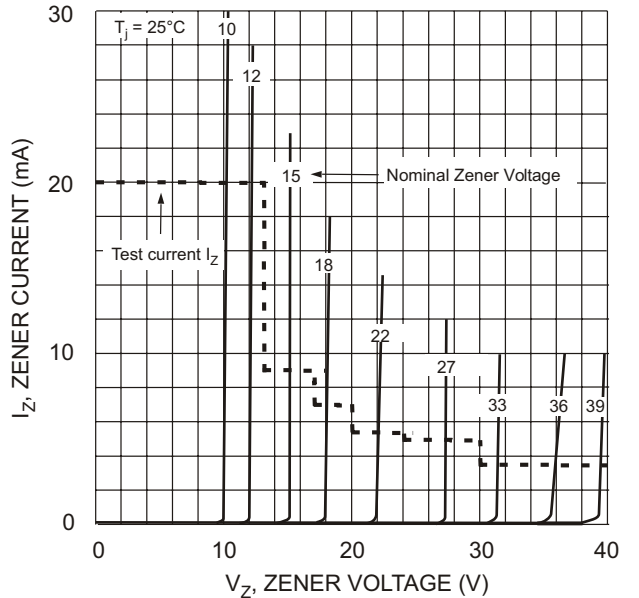

Fig. 6 Zener Breakdown Characteristics