



# Stereo Volume Control with Rotary Encoder Interface

MAX5440

## General Description

The MAX5440 dual, 40k $\Omega$  logarithmic taper volume control features a debounced up/down interface for use with a simple rotary encoder without using a microcontroller ( $\mu$ C). Each potentiometer has 32 log-spaced tap points with a buffered wiper output and replaces mechanical potentiometers. An integrated bias generator provides the required  $((V_{DD} + V_{SS}) / 2)$  bias voltage, eliminating the need for costly external op-amp circuits in unipolar audio applications. A mode-indicator LED output specifies volume or balance control. Five integrated LED drivers indicate volume level or balance settings, depending on the status of the mode indicator.

The MAX5440 includes debounced pushbutton inputs for mute and mode. The mute input allows a single pushbutton to change between volume control and the -90dB (typ) mute setting. The mode input toggles between volume and balance control. A click-and-pop suppression feature minimizes the audible noise generated by wiper transitions. The MAX5440 provides a nominal temperature coefficient of 35ppm/ $^{\circ}$ C end-to-end and 5ppm/ $^{\circ}$ C, ratiometrically. The MAX5440 is available in a 24-pin SSOP package and is specified for operation over the -40 $^{\circ}$ C to +85 $^{\circ}$ C extended temperature range.

## Applications

Stereo Volume Control  
Desktop Speakers  
Multimedia Docking Stations  
Set-Top Boxes  
Automotive Back-Seat Multimedia

## Pin Configuration

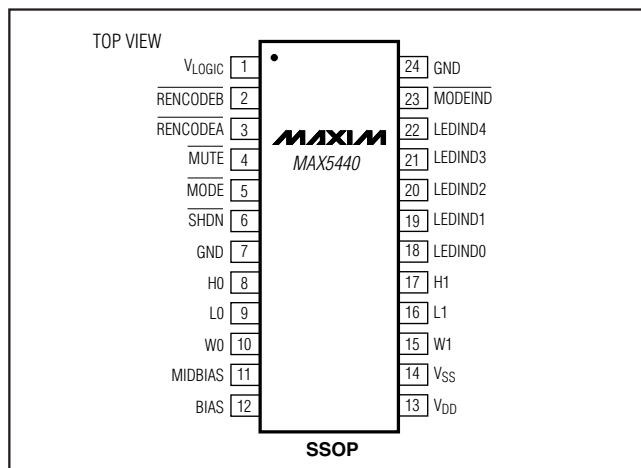

## Features

- ◆ Logarithmic Taper Volume Control with (31) 2dB Steps
- ◆ Low-Power Wiper Buffers Provide 0.003% THD
- ◆ Single +2.7V to +5.5V or Dual  $\pm$ 2.7V Supply Voltage Operation
- ◆ Low 0.5 $\mu$ A Shutdown Supply Current
- ◆ Integrated Bias Voltage Generator
- ◆ Five-Segment LED Volume/Balance Indicator
- ◆ Clickless Switching
- ◆ 40k $\Omega$  End-to-End Fixed Resistance Value
- ◆ Mute Function Toggles to -90dB (typ)
- ◆ Power-On Reset to -12dBFS Wiper Position

## Ordering Information

PART	TEMP RANGE	PIN-PACKAGE
MAX5440EAG	-40 $^{\circ}$ C to +85 $^{\circ}$ C	24 SSOP

## Typical Operating Circuit

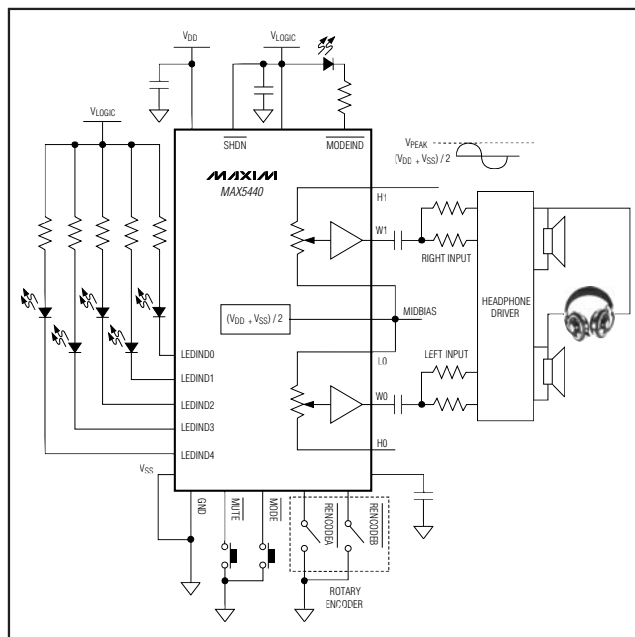

# Stereo Volume Control with Rotary Encoder Interface

## ABSOLUTE MAXIMUM RATINGS

SHDN, MUTE, RENCODEA, RENCODEB, and MODE to GND.....	-0.3V to (V <sub>LOGIC</sub> + 0.3V)	V <sub>SS</sub> to GND.....	-3V to +0.3V
H <sub>-</sub> , L <sub>-</sub> , and W <sub>-</sub> to V <sub>SS</sub> .....	-0.3V to (V <sub>DD</sub> + 0.3V)	Input and Output Latchup Immunity.....	±200mA
LEDIND <sub>-</sub> , MODEIND to GND.....	-0.3V to (V <sub>LOGIC</sub> + 0.3V)	Continuous Power Dissipation (T <sub>A</sub> = +70°C) 24-Pin SSOP (derate 12.3mW/°C above +70°C) .....	987.7mW
MIDBIAS, BIAS to V <sub>SS</sub> .....	(V <sub>SS</sub> - 0.3V) to (V <sub>DD</sub> + 0.3V)	Operating Temperature Range .....	-40°C to +85°C
V <sub>LOGIC</sub> to GND.....	-0.3V to (V <sub>DD</sub> + 0.3V)	Junction Temperature .....	+150°C
V <sub>DD</sub> to GND.....	-0.3V to +6V	Storage Temperature Range .....	-60°C to +150°C
V <sub>DD</sub> to V <sub>SS</sub> .....	-0.3V to +6V	Lead Temperature (soldering, 10s).....	+300°C

Stresses beyond those listed under "Absolute Maximum Ratings" may cause permanent damage to the device. These are stress ratings only, and functional operation of the device at these or any other conditions beyond those indicated in the operational sections of the specifications is not implied. Exposure to absolute maximum rating conditions for extended periods may affect device reliability.

## ELECTRICAL CHARACTERISTICS

(V<sub>DD</sub> = +2.7V to +5.5V, V<sub>SS</sub> = V<sub>GND</sub> = 0, 2.7V ≤ (V<sub>DD</sub> - V<sub>SS</sub>) ≤ 5.5V, V<sub>LOGIC</sub> = +2.7V to V<sub>DD</sub>, V<sub>H-</sub> = V<sub>DD</sub>, V<sub>L-</sub> = V<sub>DD</sub> / 2, T<sub>A</sub> = T<sub>MIN</sub> to T<sub>MAX</sub>, unless otherwise specified. Typical values are at T<sub>A</sub> = +25°C.) (Note 1)

PARAMETER	SYMBOL	CONDITIONS	MIN	TYP	MAX	UNITS
End-to-End Resistance	R		36	40	52	kΩ
Absolute Tolerance				±0.25		dB
Tap-to-Tap Tolerance				±0.1		dB
Total Harmonic Distortion Plus Noise	THD+N	V <sub>H-</sub> = (V <sub>DD</sub> / 2) + 1V <sub>RMS</sub> , 1kHz tap at top, R <sub>L</sub> = ∞ to V <sub>L-</sub> = V <sub>DD</sub> / 2, 20Hz to 20kHz		0.004		%
		V <sub>H-</sub> = (V <sub>DD</sub> / 2) + 1.5V <sub>RMS</sub> , 1kHz tap at top, R <sub>L</sub> = ∞ to V <sub>L-</sub> = V <sub>DD</sub> / 2, 20Hz to 20kHz		0.006		
		V <sub>DD</sub> = 5V, V <sub>SS</sub> = 0V, V <sub>L-</sub> = 1.5V, V <sub>H-</sub> = (V <sub>DD</sub> / 2) + 1V <sub>RMS</sub> , 1kHz tap at top, R <sub>L</sub> = 10kΩ to V <sub>MIDBIAS</sub> , 20Hz to 20kHz		0.004		
		V <sub>DD</sub> = 5V, V <sub>SS</sub> = 0V, V <sub>L-</sub> = 5V, V <sub>H-</sub> = (V <sub>DD</sub> / 2) + 1.5V <sub>RMS</sub> , 1kHz tap at top, R <sub>L</sub> = 10kΩ to V <sub>MIDBIAS</sub> , 20Hz to 20kHz		0.006		
Channel Isolation				100		dB
Interchannel Matching				±0.5		dB
Mute Attenuation		$\overline{\text{SHDN}} = V_{DD}$		90		dB
Power-Supply Rejection Ratio	PSRR	Input referred, 217Hz, 100mV <sub>P-P</sub> on V <sub>DD</sub>		-60		dB
H Terminal Capacitance	C <sub>H</sub>			5		pF
L Terminal Capacitance	C <sub>L</sub>			7		pF
End-to-End Resistance				35		ppm/°C
Ratiometric Resistance				5		ppm/°C
Bandwidth, -3dB	f <sub>CUTOFF</sub>	C <sub>W</sub> = 33pF		100		kHz
Output Noise	e <sub>n</sub>	20Hz to 20kHz		3.2		μV <sub>RMS</sub>
<b>WIPER BUFFER</b>						
Output Voltage Swing	V <sub>O</sub>	R <sub>L</sub> = 10kΩ to V <sub>MIDBIAS</sub>		V <sub>DD</sub> - 0.2		V
Output Current					3	mA
Output Resistance	ROWB			1	10	Ω
DC Offset			-14	±2	+14	mV
<b>INTEGRATED BIAS GENERATOR</b>						
Output Voltage		I <sub>LOAD</sub> = 1mA	(V <sub>DD</sub> + V <sub>SS</sub> ) / 2 - 30mV	(V <sub>DD</sub> + V <sub>SS</sub> ) / 2	(V <sub>DD</sub> + V <sub>SS</sub> ) / 2 + 30mV	V

# Stereo Volume Control with Rotary Encoder Interface

**MAX5440**

## ELECTRICAL CHARACTERISTICS (continued)

( $V_{DD} = +2.7V$  to  $+5.5V$ ,  $V_{SS} = V_{GND} = 0$ ,  $2.7V \leq (V_{DD} - V_{SS}) \leq 5.5V$ ,  $V_{LOGIC} = +2.7V$  to  $V_{DD}$ ,  $V_{H\_} = V_{DD}$ ,  $V_{L\_} = V_{DD} / 2$ ,  $T_A = T_{MIN}$  to  $T_{MAX}$ , unless otherwise specified. Typical values are at  $T_A = +25^\circ C$ .) (Note 1)

PARAMETER	SYMBOL	CONDITIONS	MIN	TYP	MAX	UNITS
Power-Supply Rejection Ratio	PSRR <sub>BR</sub>	1kHz, 100mV on $V_{DD}$ , 1 $\mu$ F on BIAS		60		dB
Maximum Load		To $V_{DD}$ or GND	3			k $\Omega$
Output Resistance	R <sub>OBR</sub>			6		$\Omega$
<b>CONTACT INPUTS (MUTE, MODE, RENCODEA, RENCODEB)</b>						
Internal Pullup Resistor	RPULLUP			45		k $\Omega$
Single Pulse Input Low Time	t <sub>CPW</sub>		22			ms
Repetitive Input Pulse Separation	t <sub>IPWS</sub>		66			ms
Timeout Period	t <sub>WS</sub>	Click/pop suppression inactive		32		ms
<b>DIGITAL INPUTS (MUTE, MODE, RENCODEA, RENCODEB, SHDN)</b>						
Input High Voltage (Note 2)	V <sub>IH</sub>	$3.6V < V_{LOGIC} \leq 5.5V$	2.4			V
		$2.7V \leq V_{LOGIC} \leq 3.6V$	2.0			
Input Low Voltage (Note 2)	V <sub>IL</sub>	$3.6V < V_{LOGIC} \leq 5.5V$			0.8	V
		$2.7V \leq V_{LOGIC} \leq 3.6V$			0.6	
Input Leakage Current		Inputs unconnected	-1		+1	$\mu$ A
Input Capacitance				5		pF
<b>POWER SUPPLIES</b>						
Supply Voltage	V <sub>DD</sub>	$V_{SS} = 0$	2.7		5.5	V
Negative Power Supply	V <sub>SS</sub>	$V_{DD} = +2.7V$	-2.7		0	V
Supply Voltage Difference		$V_{DD} - V_{SS}$			5.5	V
Active Supply Current	I <sub>DD</sub>				1.4	mA
Standby Supply Current (Notes 3, 4)	I <sub>STBY</sub>	$V_{DD} = +5V, V_{SS} = 0$			1.3	mA
		$V_{DD} = +2.7V, V_{SS} = -2.7V$			1.3	
Shutdown Supply Current	I <sub>SHDN</sub>	(Note 3)			1	$\mu$ A
Power-Up Time	t <sub>PU</sub>	Click/pop suppression inactive		50		ms
Logic Supply Voltage	V <sub>LOGIC</sub>	$V_{SS} = 0$	2.7		$V_{DD}$	V
Logic Active Supply Current	I <sub>L</sub>	$V_{RENCODEA} = V_{RENCODEB} = 0V$			320	$\mu$ A
Logic Standby Supply Current	I <sub>LSTBY</sub>	(Note 4)			1	$\mu$ A
Logic Shutdown Current	I <sub>LSDN</sub>				1	$\mu$ A
<b>LED INDICATORS (LEDIND0–LEDIND4, MODEIND)</b>						
Output Low Voltage	V <sub>OL</sub>	$V_{LOGIC} = 2.7V, I_{SINK} = 10mA$			0.4	V
		$V_{LOGIC} = 5.5V, I_{SINK} = 10mA$			0.2	
Output Leakage Current				0.1	10	$\mu$ A
Output Capacitance				3		pF
Maximum Sink Current				150		mA

**Note 1:** Parameters are 100% production tested at  $+85^\circ C$  and limits through temperature are guaranteed by design.

**Note 2:** The device draws current in excess of the specified supply current when the digital inputs are driven with voltages between ( $V_{DD} - 0.5V$ ) and ( $GND + 0.5V$ ). See Digital Supply Current vs. Digital Input Voltage in the *Typical Operating Characteristics*.

**Note 3:** Shutdown refers to the  $\overline{SHDN}$  input being asserted low. Standby refers to  $\overline{SHDN}$  not being asserted and all I/O inactive.

**Note 4:** Supply current measured with the wiper position fixed.

# Stereo Volume Control with Rotary Encoder Interface

## Typical Operating Characteristics

( $T_A = +25^\circ\text{C}$ , unless otherwise noted.)

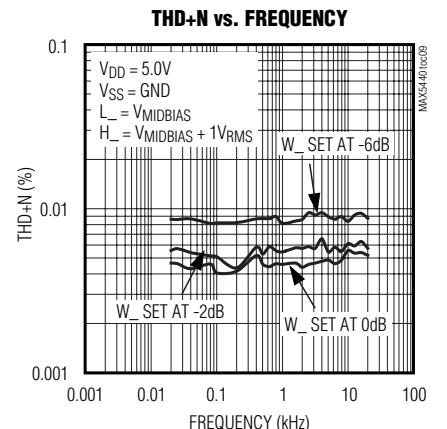
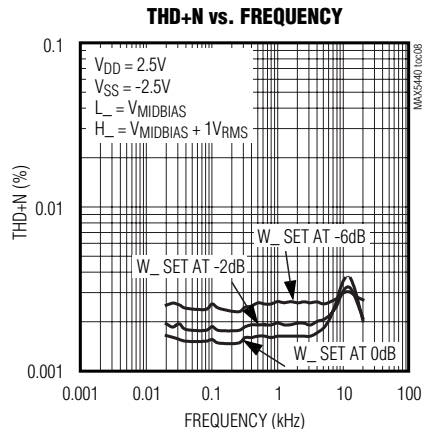
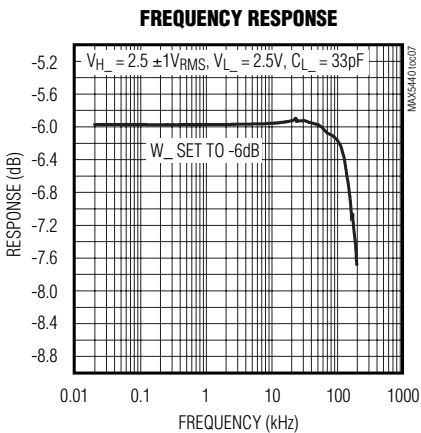
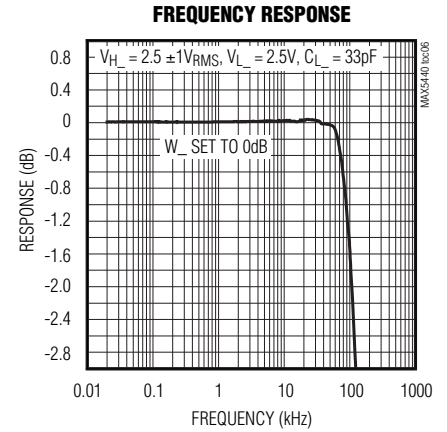
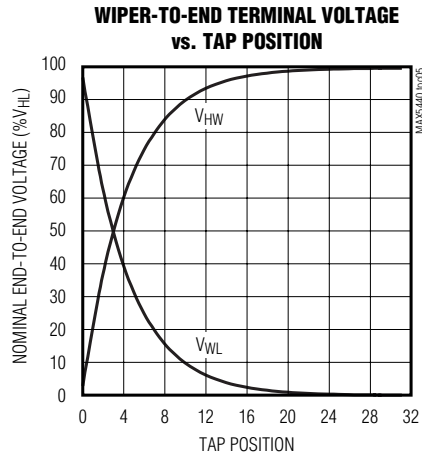
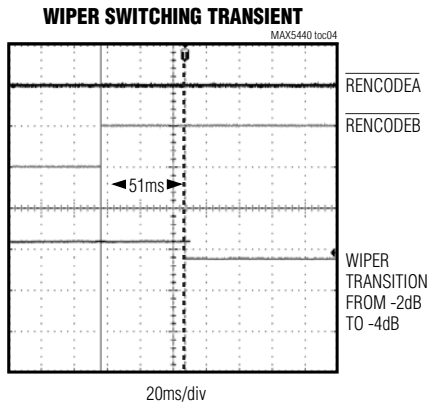
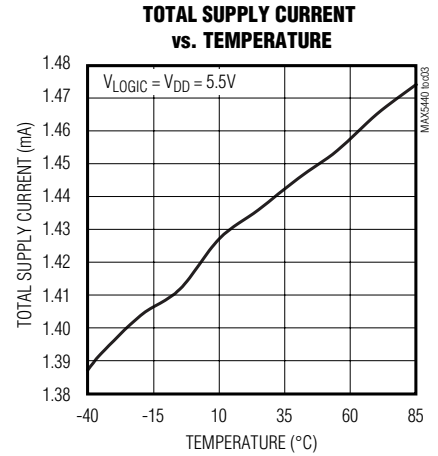
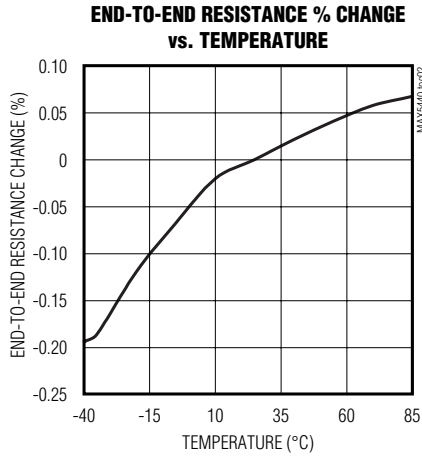
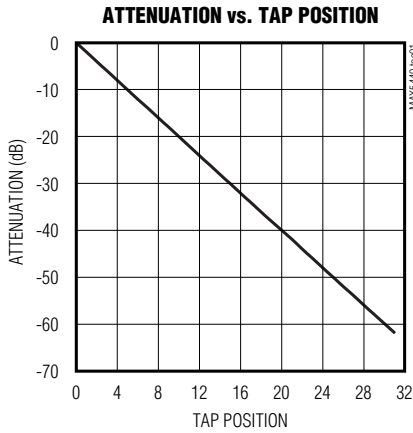

# Stereo Volume Control with Rotary Encoder Interface

## Typical Operating Characteristics (continued)

( $V_{DD} = +5V$ ,  $T_A = +25^\circ C$ , unless otherwise noted.)

MAX5440

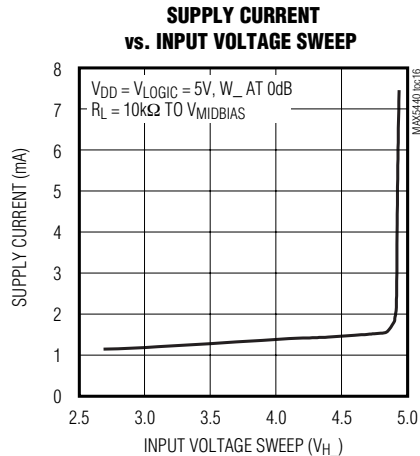
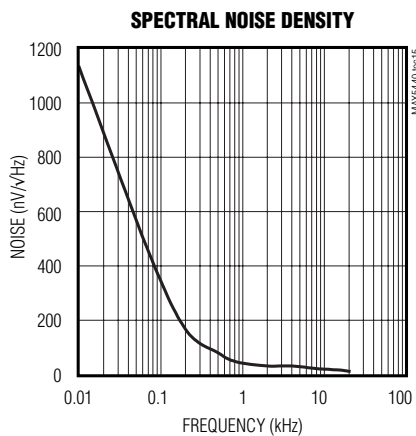
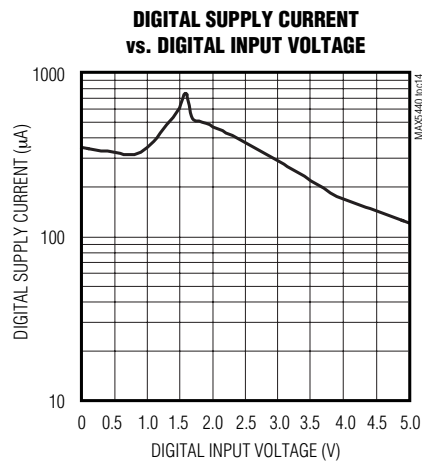
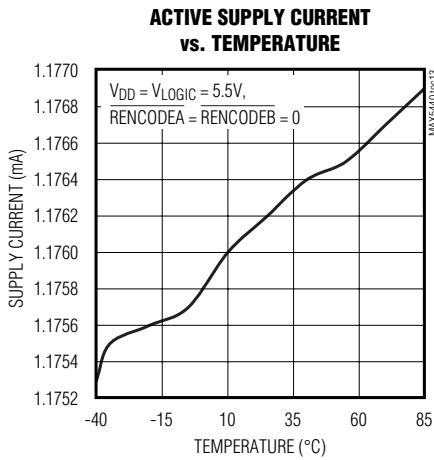
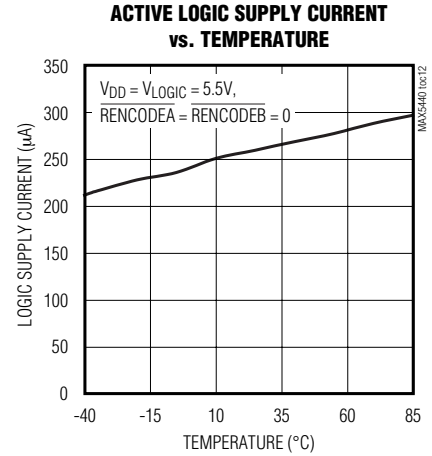
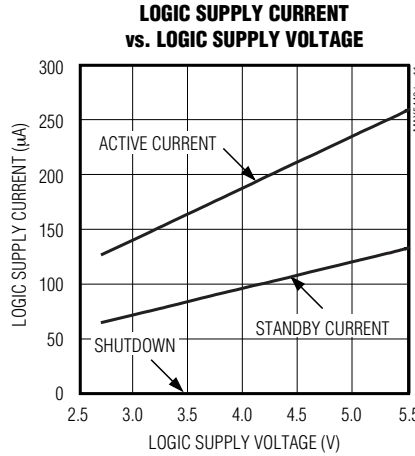
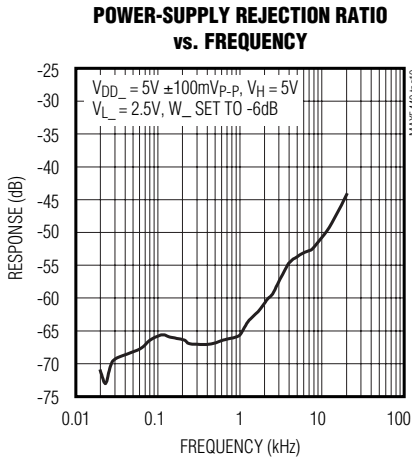

# Stereo Volume Control with Rotary Encoder Interface

## Pin Description

PIN	NAME	FUNCTION
1	V <sub>LOGIC</sub>	Digital Logic Power Supply. Bypass V <sub>LOGIC</sub> to ground with a 0.1µF capacitor as close to the device as possible.
2	$\overline{\text{RENCODEB}}$	Rotary Encoder Input B. With $\overline{\text{RENCODEA}}$ , this input provides the rotary encoder control for the potentiometer (see Figure 1). $\overline{\text{RENCODEB}}$ is internally pulled up to V <sub>LOGIC</sub> with a 45kΩ resistor.
3	$\overline{\text{RENCODEA}}$	Rotary Encoder Input A. With $\overline{\text{RENCODEB}}$ , this input provides the rotary encoder control for the potentiometer (see Figure 1). $\overline{\text{RENCODEA}}$ is internally pulled up to V <sub>LOGIC</sub> with a 45kΩ resistor.
4	$\overline{\text{MUTE}}$	Mute Input. Pull $\overline{\text{MUTE}}$ low to toggle the wiper between the mute setting (see Table 1) and the current setting. $\overline{\text{MUTE}}$ is pulled up to V <sub>LOGIC</sub> with an internal 45kΩ resistor.
5	$\overline{\text{MODE}}$	Volume/Balance Control Input. Each high-to-low transition on $\overline{\text{MODE}}$ toggles between the volume and balance modes. $\overline{\text{MODE}}$ is pulled high internally with a 45kΩ resistor to V <sub>LOGIC</sub> . On power-up, the MAX5440 is in volume-control mode.
6	$\overline{\text{SHDN}}$	Active-Low Shutdown Input. Drive $\overline{\text{SHDN}}$ low to place the device in shutdown mode. In shutdown mode, the MAX5440 stores the last wipers settings. The wipers move to the L_ end of the resistor string. Terminating shutdown mode restores the wipers to their previous settings.
7, 24	GND	Ground. Connect pins 7 and 24 together.
8	H0	Potentiometer 0 High Terminal. H0 and L0 terminals can be reversed.
9	L0	Potentiometer 0 Low Terminal. L0 and H0 terminals can be reversed.
10	W0	Potentiometer 0 Wiper Buffered Output
11	MIDBIAS	Midbias Voltage Output. $V_{\text{MIDBIAS}} = (V_{\text{DD}} + V_{\text{SS}}) / 2$ .
12	BIAS	Bias Generator Input. Bypass with a 1µF capacitor to system ground.
13	V <sub>DD</sub>	Analog Power Supply. Bypass V <sub>DD</sub> to ground with a 0.1µF capacitor as close to the device as possible.
14	V <sub>SS</sub>	Negative Power Supply. Bypass V <sub>SS</sub> to ground with a 0.1µF capacitor as close to the device as possible. Connect to GND for single-supply operation.
15	W1	Potentiometer 1 Wiper Buffered Output
16	L1	Potentiometer 1 Low Terminal. L1 and H1 terminals can be reversed.
17	H1	Potentiometer 1 High Terminal. H1 and L1 terminals can be reversed.
18–22	LEDIND0– LEDIND4	LED Indicator Open-Drain Output 0 through LED Indicator Open-Drain Output 4. LEDIND0–LEDIND4 form a bar graph indication of the current volume or balance. In volume mode, all LEDs off indicates mute and all LEDs on indicates maximum volume. In balanced mode, LED2 on indicates centered or balanced.
23	$\overline{\text{MODEIND}}$	Volume-Control/Balance-Control Mode Indicator Open-Drain Output. Connect to an LED through a resistor to V <sub>LOGIC</sub> . When the LED is on, the MAX5440 is in balance-control mode. When the LED is off, the MAX5440 is in volume-control mode.

# Stereo Volume Control with Rotary Encoder Interface

## Detailed Description

The MAX5440 dual, 40kΩ logarithmic taper digital potentiometer features a debounced up/down interface for use with a simple rotary encoder without using a microcontroller. Each potentiometer has 32 log-spaced tap points with a buffered wiper output and replaces mechanical potentiometers.

## Mode Control (MODE)

The MAX5440 MODE input toggles between volume and balance modes. Force MODE low to toggle between volume and balance modes. For example, driving MODE low once while in volume-control mode switches the MAX5440 to balance mode. Driving MODE low again switches the MAX5440 back to volume mode. MODE is internally pulled high with a 45kΩ resistor to VLOGIC. The MAX5440 powers up in volume-control mode. Leave unconnected or connect to VLOGIC if balance mode is not required.

## Rotary Encoder Interface

The MAX5440 interfaces with rotary encoder switches. The rotary encoder is a contact closure type switch with two outputs that connect to RENCODEA and RENCODEB on the device. As the shaft is rotated, RENCODEA and RENCODEB produce a gray code count. Figure 1 shows a typical rotary encoder interface.

State changes trigger a wiper movement and the direction of the count dictates the direction of wiper movement. An increasing gray code count moves the wiper up to a lower attenuation setting in volume mode and towards a full right channel (CH1) in balance mode. A decreasing gray code count moves the wiper down to a higher attenuation in volume mode and towards a full left channel (CH0) in balance mode. Both switch inputs are internally pulled up to VLOGIC by internal 45kΩ resistors.

During rapid rotation, the inputs must be stable for at least 20ms and have separation between state changes by at least 40ms for the debounce circuitry to accurately detect the input states.

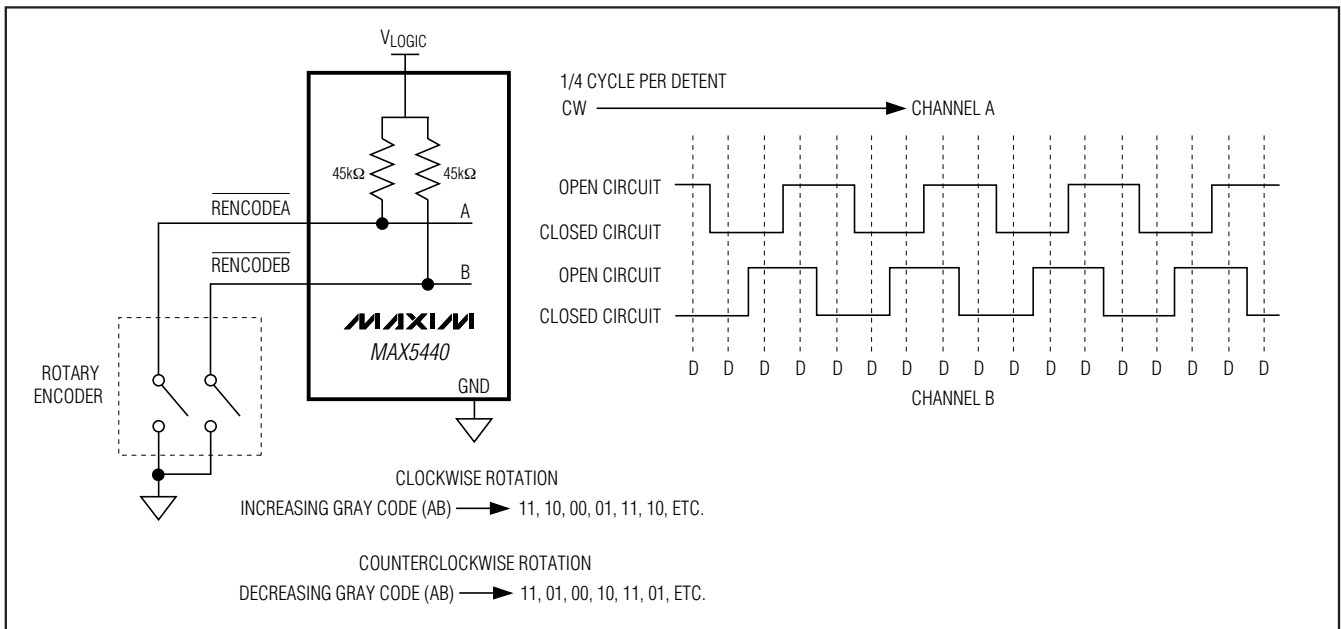

Figure 1. Rotary Encoder Interface

# Stereo Volume Control with Rotary Encoder Interface

## Volume Control

In volume-control mode, the MAX5440's wipers move simultaneously, maintaining the balance separation between each wiper (Figure 2a).

When either wiper reaches the maximum tap position (position closest to H<sub>-</sub>), further commands to increase the volume are ignored. Balance separation is maintained in the maximum volume configuration (Figure 2b).

When either wiper reaches the minimum tap position (position closest to L<sub>-</sub>), further commands to decrease

the volume adjust the other wiper until it also reaches the minimum tap position (Figure 2c).

Increasing the volume from this minimum position restores the original balance separation of the wipers (Figure 2d).

When both wipers are in the tap 31 position (-62dB attenuation), further decreasing rotations place the wipers in the mute position (see Table 1). Rotating the encoder to a lower attenuation or a pulse to MUTE returns the wipers to tap 31.

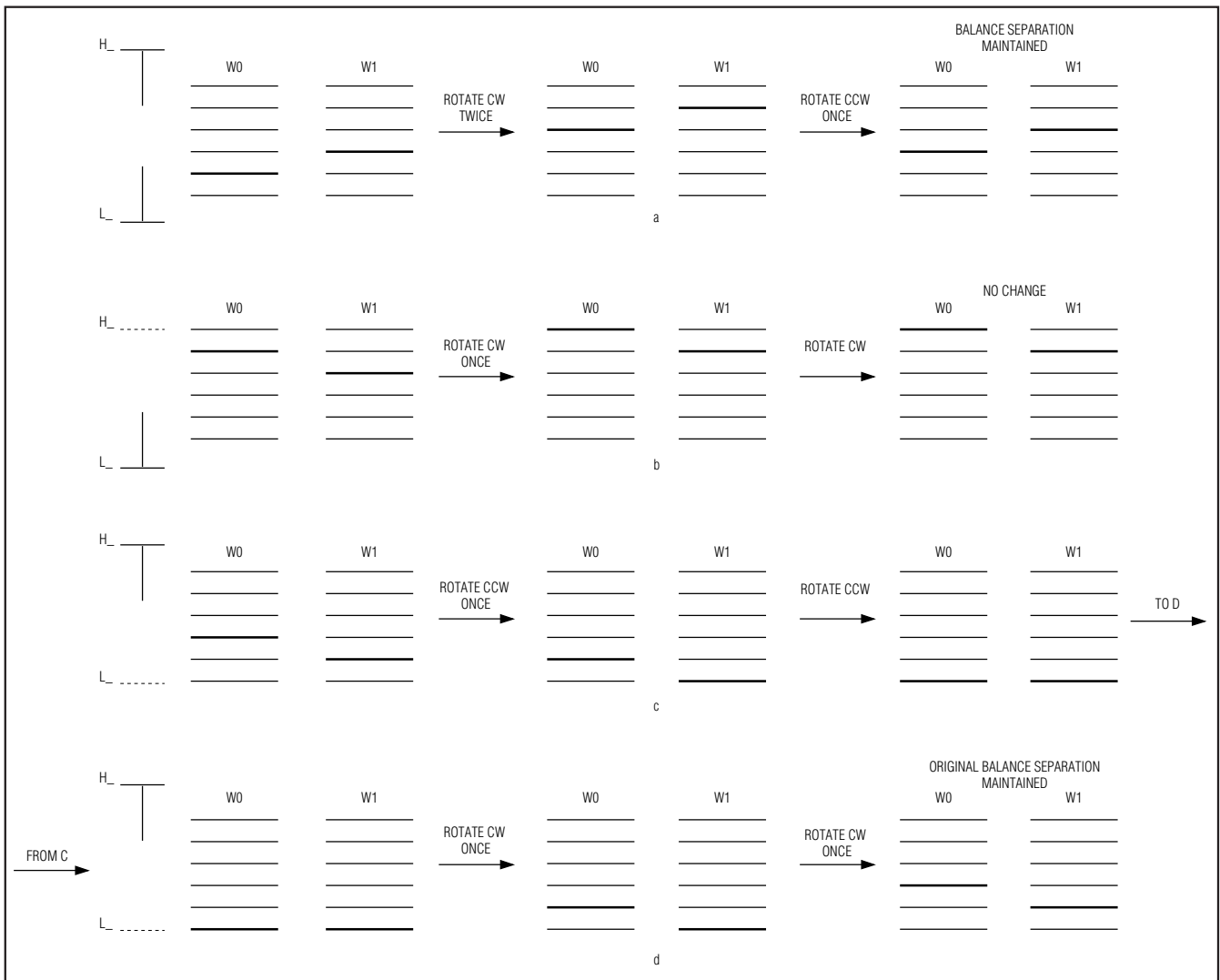

Figure 2. Volume-Control Operation



# Stereo Volume Control with Rotary Encoder Interface

**Table 1. Wiper Position and Attenuation**

POSITION	ATTENUATION (dB)
0	0
1	-2
2	-4
...	...
6 (POR)	-12
...	...
30	-60
31	-62
32 (MUTE)	≥ 90

**Balance Control**

In balance-control mode, the MAX5440 adjusts the balance between channel 0 and channel 1 while maintaining the set volume. For example, if the volume of channel 0 equals the volume of channel 1, forcing the balance towards channel 1 increases the attenuation of channel 0 (Figure 3a). If channel 1 is at a higher attenuation than channel 0, adjusting the balance to channel 1 moves channel 1's wiper up to the same wiper position as channel 0 before it was attenuated (Figure 3b).

**Click-and-Pop Suppression**

The click-and-pop suppression feature reduces the audible noise (clicks and pops) that results from wiper transitions. The MAX5440 minimizes this noise by allowing the wiper to change position only when  $V_H = V_L$ . Each wiper has its own suppression and timeout circuitry. The MAX5440 changes wiper position when  $V_H = V_L$ , or after 32ms, whichever occurs first (see Figures 4a and 4b).

The suppression circuitry monitors left and right channels separately. In volume-control mode, when the first wiper changes position, the second wiper has 32ms to change or it will be forced to change.

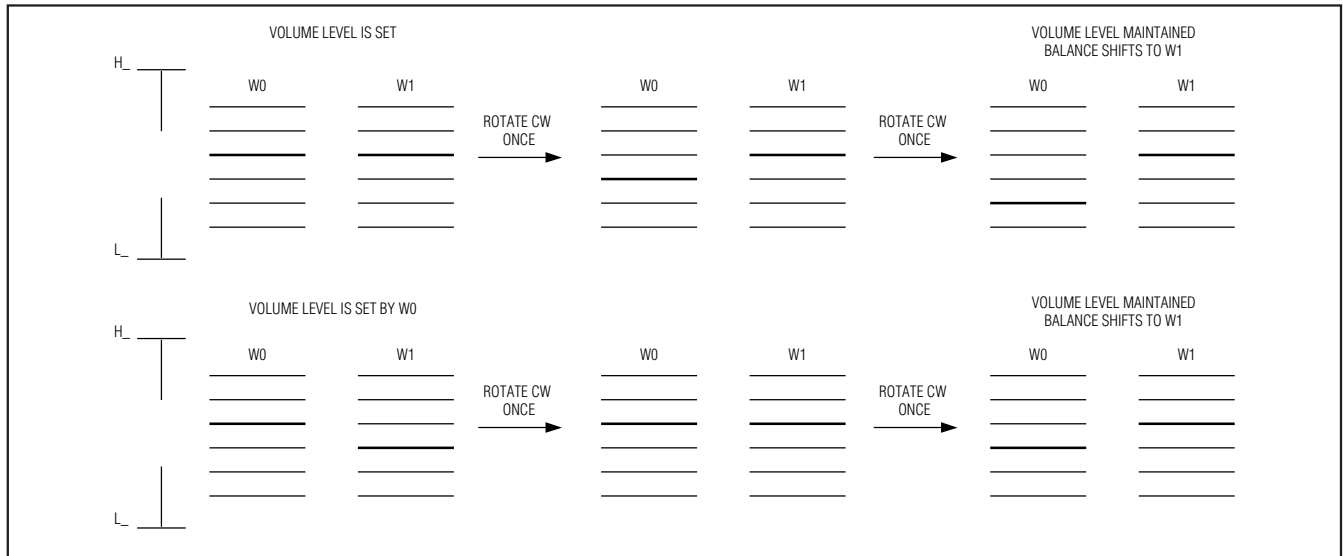

Figure 3. Balance-Control Operation

# Stereo Volume Control with Rotary Encoder Interface

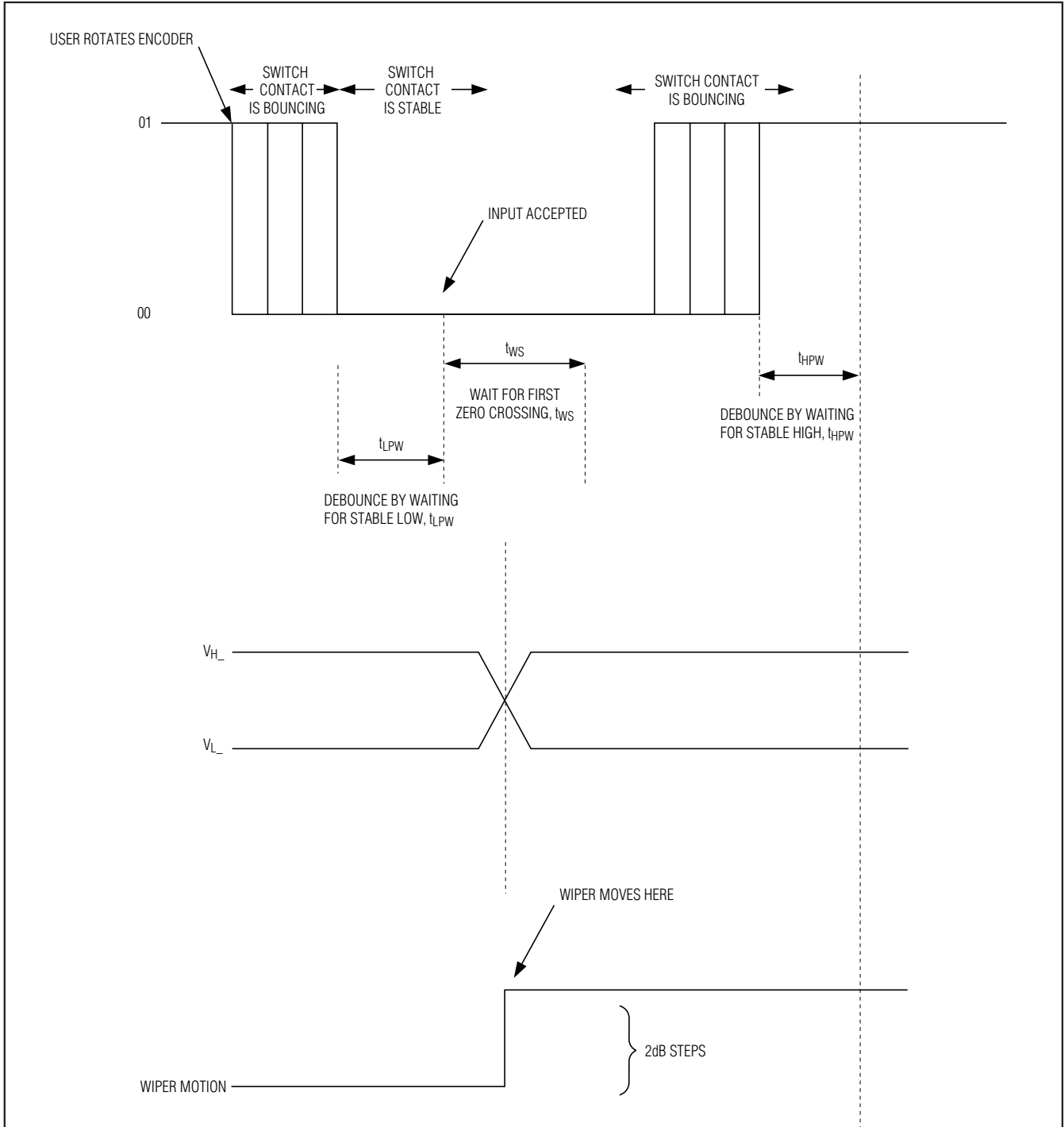

Figure 4a. Wiper Transition Timing Diagram—Suppression Circuitry Active

# Stereo Volume Control with Rotary Encoder Interface

MAX5440

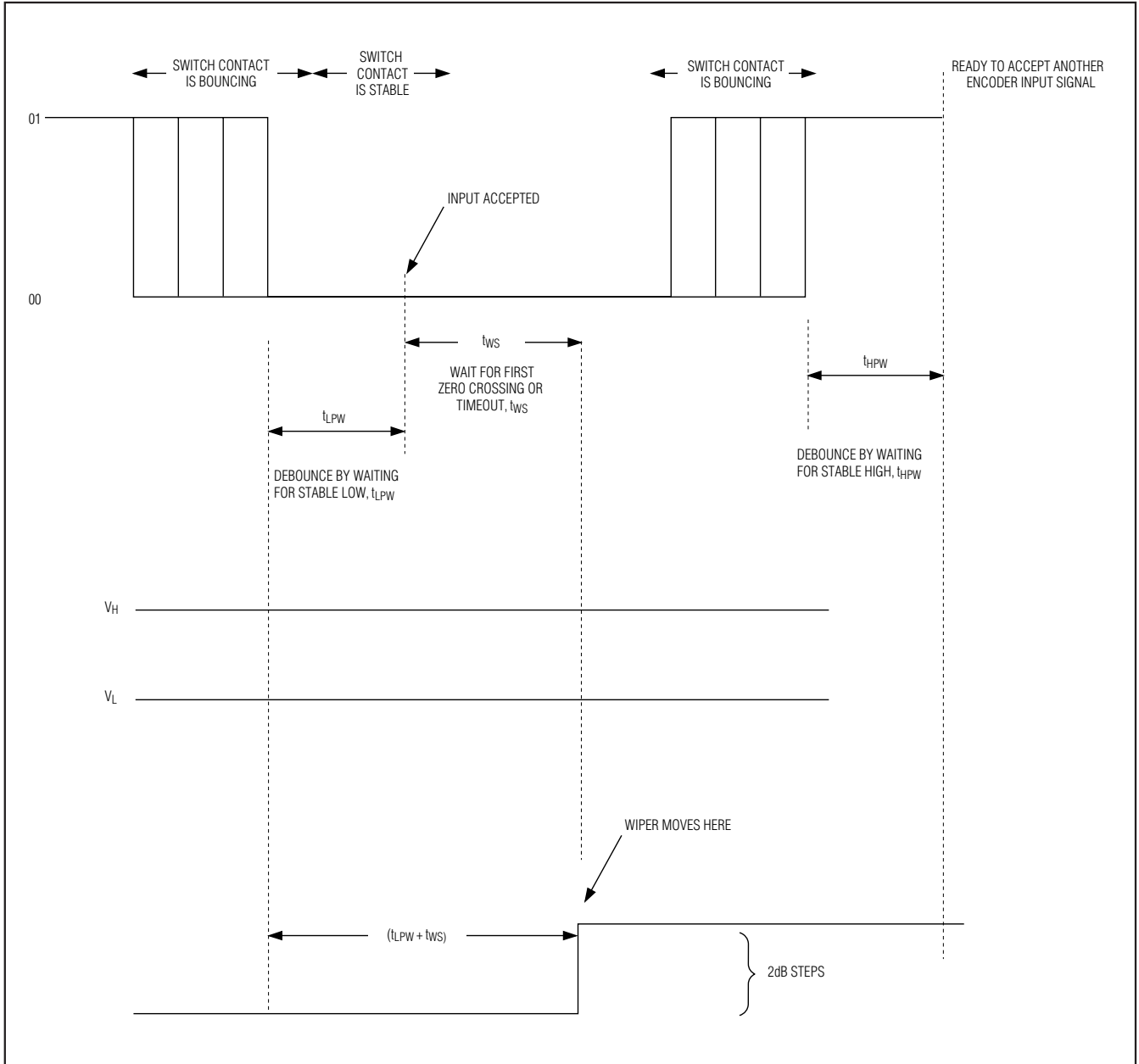

Figure 4b. Wiper Transition Timing Diagram—Timed Out

# Stereo Volume Control with Rotary Encoder Interface

## Power-On Reset

The power-on comparators monitor ( $V_{DD} - V_{SS}$ ) and ( $V_{LOGIC} - GND$ ). A power-on reset is initiated when either of the supplies is brought back to the normal operating voltage. The power-on reset feature sets both wipers to -12dB. The wipers initially wake up in mute mode (-90dB) and move to the -12dB position when  $V_H = V_L$  to eliminate clicks and pops during power-up. With DC inputs at  $V_H$  and  $V_L$ , the wipers move after exceeding the timeout period. A power-on reset places the MAX5440 in volume-control mode.

## Shutdown ( $\overline{SHDN}$ )

Upon entering shutdown, the MAX5440 stores the last wiper settings. The wipers move to the  $L_-$  end of the resistor string. The wipers move to the  $L_-$  end of the resistor string when  $V_H = V_L$  to eliminate clicks and pops during shutdown. With DC inputs at  $V_H$  and  $V_L$ , the wipers move after exceeding the timeout period. Exiting shutdown restores the wipers to their previous settings.

## Mute Function ( $\overline{MUTE}$ )

The MAX5440 features a mute function input,  $\overline{MUTE}$ . Successive low pulses on  $\overline{MUTE}$  toggle its setting. Activating the mute function forces both wipers to maximum attenuation (-90dB typ). Deactivating the mute function returns the wipers to their previous settings. Rotating the encoder clockwise (increasing gray code count) also deactivates mute, setting the wipers to their previous positions.  $\overline{MUTE}$  is internally pulled high with a 45k $\Omega$  resistor to  $V_{LOGIC}$ . When both wipers are in the tap 31 position (-62dB attenuation) further commands to lower the volume (decreasing gray code count) place the wipers in the mute position (see Table 1). Rotating the encoder to a lower attenuation or a pulse to  $\overline{MUTE}$  returns the wipers to tap 31.

## Mode Indicator ( $\overline{MODEIND}$ )

The open-drain  $\overline{MODEIND}$  indicates volume-control mode or balance-control mode for the MAX5440. Connect  $\overline{MODEIND}$  to an LED with a series resistor to  $V_{LOGIC}$ . When the LED is on, the MAX5440 is in balance-control mode. When the LED is off, the MAX5440 is in volume-control mode. See the *Mode Control ( $\overline{MODE}$ )* section for more detail on switching between modes.

## Level Indicator LEDs

The MAX5440 includes five indicator LED drivers to display the current wiper settings in either volume or balance mode. Connect the  $\overline{LEDIND}_n$  outputs to the LEDs and to  $V_{LOGIC}$  through a series resistor as shown in the typical application circuits.

In volume-control mode, all LEDs are off when the wipers reach the highest attenuation levels (mute). All LEDs are on at the lowest attenuation levels (0dB). Table 2 shows the LED display as the wipers transition through various attenuation levels.

In balance-control mode, only one LED is on at a time to indicate the current balance setting. Figure 5 shows the LEDs display for the current balance setting. When LED2 is on, the display indicates that the channels are centered or balanced at a set volume level. Turning the encoder clockwise (an increasing gray code count) turns LED3 on to represent a balance shift towards channel 1. When LED4 turns on, the balance shifts completely toward channel 1 and channel 0 is fully attenuated. From a balanced position, turning the encoder counterclockwise (a decreasing gray code count) turns on LED1, and then LED0 to indicate a balance shift towards channel 0.

Table 2. LED Settings in Volume Mode

VOLUME POSITION (dB)	VOLUME LED OUTPUTS (1 = LED IS ON)				
	LED0	LED1	LED2	LED3	LED4
0 to -8	1	1	1	1	1
-10 to -18	1	1	1	1	0
-20 to -28	1	1	1	0	0
-30 to -38	1	1	0	0	0
-40 to -52	1	0	0	0	0
-54 to mute (-90)	0	0	0	0	0

# Stereo Volume Control with Rotary Encoder Interface

MAX5440

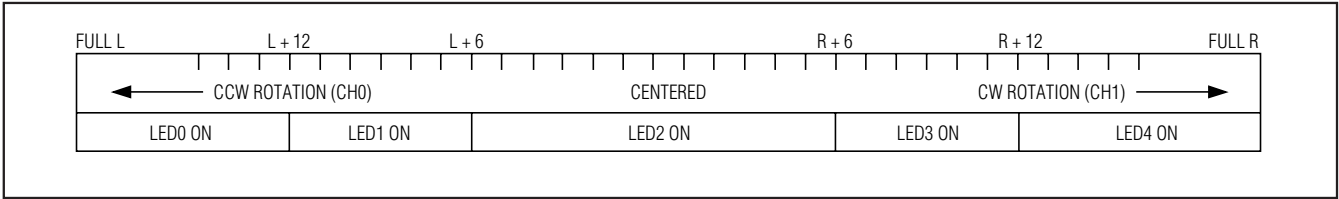

Figure 5. LED Setting in Balance Mode

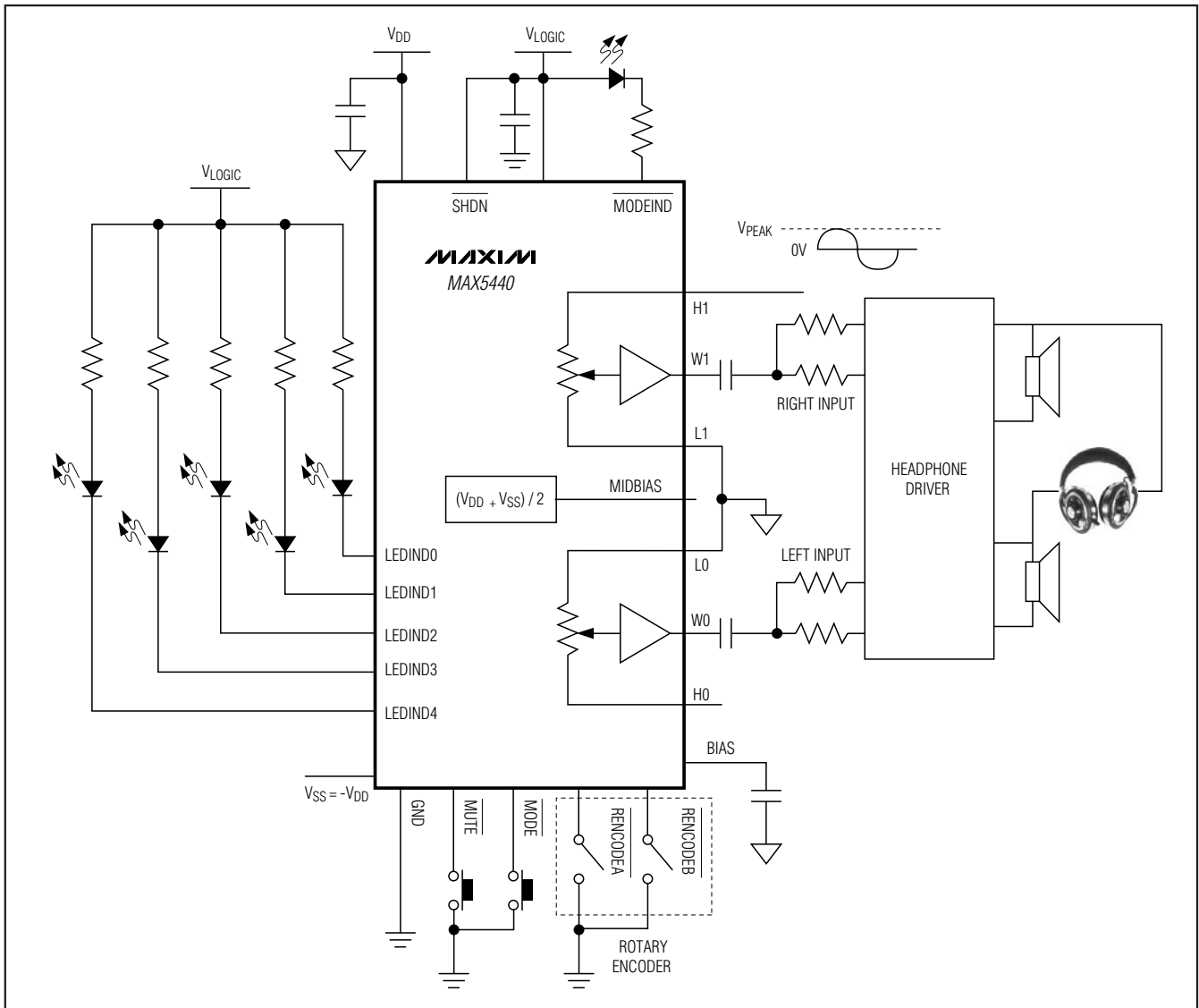

Figure 6. Dual-Supply Volume/Balance Control

# Stereo Volume Control with Rotary Encoder Interface

## Multiple Button Pushes ( $\overline{\text{MODE}}$ , $\overline{\text{MUTE}}$ )

The MAX5440 does not respond to simultaneous button pushes. Pushing more than one button at the same time stops the wipers in their present states. Only a single button push configures the device.

## Applications Information

### Typical Application Circuit

The *Typical Operating Circuit* shows the MAX5440 in a typical volume/balance application using a single-supply configuration. Figure 6 shows a typical volume/balance application circuit using the MAX5440 in a dual-supply configuration. The MAX5440 does not require external op amps because the bias is generated internally, and the wipers have internal low-power buffers for low distortion. Connect the  $W_{\_}$  outputs of the MAX5440 to the left and right inputs of a stereo audio amplifier, such as the MAX9761. The rotary encoder controls the potentiometer attenuation levels without using a microcontroller. Use the  $\overline{\text{MODE}}$  input to switch between volume-control and balance-control modes.

## Chip Information

PROCESS: BiCMOS

# Stereo Volume Control with Rotary Encoder Interface

## Functional Diagram

MAX5440

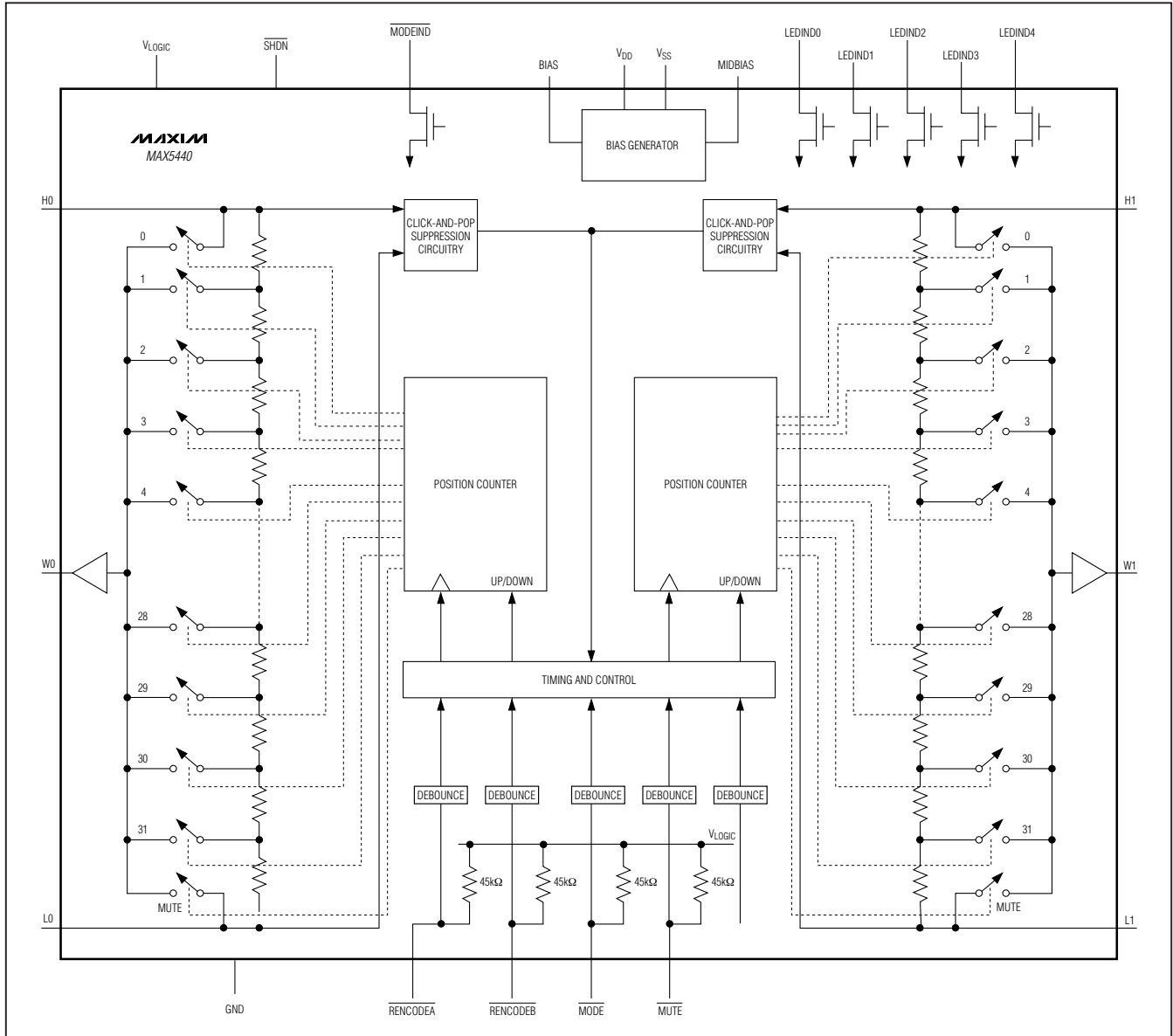

### Package Information

For the latest package outline information and land patterns, go to [www.maxim-ic.com/packages](http://www.maxim-ic.com/packages).

PACKAGE TYPE	PACKAGE CODE	DOCUMENT NO.
24 SSOP	A24-1	<a href="#">21-0056</a>

# **Stereo Volume Control with Rotary Encoder Interface**

## **Revision History**

<b>REVISION NUMBER</b>	<b>REVISION DATE</b>	<b>DESCRIPTION</b>	<b>PAGES CHANGED</b>
2	11/08	Fixed pin names and thermal data. Updated two specifications in EC table	1, 2, 3, 6, 13

*Maxim cannot assume responsibility for use of any circuitry other than circuitry entirely embodied in a Maxim product. No circuit patent licenses are implied. Maxim reserves the right to change the circuitry and specifications without notice at any time.*

16 **Maxim Integrated Products, 120 San Gabriel Drive, Sunnyvale, CA 94086 408-737-7600**