

# Xinger®

## Ultra Low Profile 0805 Balun 50Ω to 200Ω Balanced

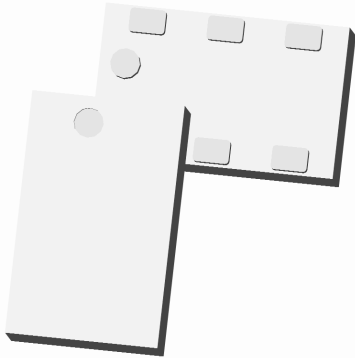

### Description

The BD0826J50200A00 is a low profile sub-miniature balanced to unbalanced transformer designed for differential inputs and output locations on next generation wireless chipsets in an easy to use surface mount package covering the GSM, DCS, PCS, UMTS, CDMA and 802.11 b+g+n frequencies. The BD0826J50200A00 is ideal for high volume manufacturing and is higher performance than traditional ceramic, and lumped element baluns. The BD0826J50200A00 has an unbalanced port impedance of 50Ω and a 200Ω balanced port impedance. This transformation enables single ended signals to be applied to differential ports on modern integrated chipsets. The output ports have equal amplitude (-3dB) with 180 degree phase differential. The BD0826J50200A00 is available on tape and reel for pick and place high volume manufacturing.

### Detailed Electrical Specifications: Specifications subject to change without notice.

| Features:  | Parameter                 | ROOM (25°C) |      |      | Unit    |
|--|---------------------------|-------------|------|------|---------|
|  |                           | Min.        | Typ. | Max  |         |
| <ul style="list-style-type: none"> <li>• 800 – 2600 MHz</li> <li>• 0.7mm Height Profile</li> <li>• 50 Ohm to 2 x 100 Ohm</li> <li>• GSM/DCS/PCS/UMTS/CDMA</li> <li>• Low Insertion Loss</li> <li>• Input to Output DC Isolation</li> <li>• Surface Mountable</li> <li>• Tape &amp; Reel</li> <li>• Non-conductive Surface</li> <li>• RoHS Compliant</li> </ul> | Frequency                 | 800         |      | 2600 | MHz     |
|  | Unbalanced Port Impedance |             | 50   |      | Ω       |
|  | Balanced Port Impedance   |             | 200  |      | Ω       |
|  | Return Loss               | 8.5         | 13   |      | dB      |
|  | Insertion Loss*           |             | 1.2  | 1.5  | dB      |
|  | Amplitude Balance         |             | 0.4  | 1.3  | dB      |
|  | Phase Balance             |             | 3    | 7    | Degrees |
|  | CMRR                      |             | 30   |      | dB      |
|  | Power Handling            |             |      | 2    | Watts   |
|  | Operating Temperature     |             | -55  |      | +85     |

\* Insertion Loss stated at room temperature (Insertion Loss is approximately 0.1 dB higher at +85 °C)

### Outline Drawing

Top View (Near-side)

Orientation Marker Denotes Pin Location

Side View

Bottom View (Far-side)

Orientation Marker Denotes Pin Location

| Pin | Designation            |
|-----|------------------------|
| 1   | Unbalanced Port        |
| 2   | GND / DC Feed + RF GND |
| 3   | Balanced Port          |
| 4   | Balanced Port          |
| 5   | GND                    |
| 6   | NC                     |

Tolerances are Non-Cumulative

Dimensions are in Inches [Millimeters]  
Mechanical Outline

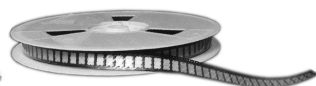

## Typical Broadband Performance: 500 MHz. to 8.0 GHz.

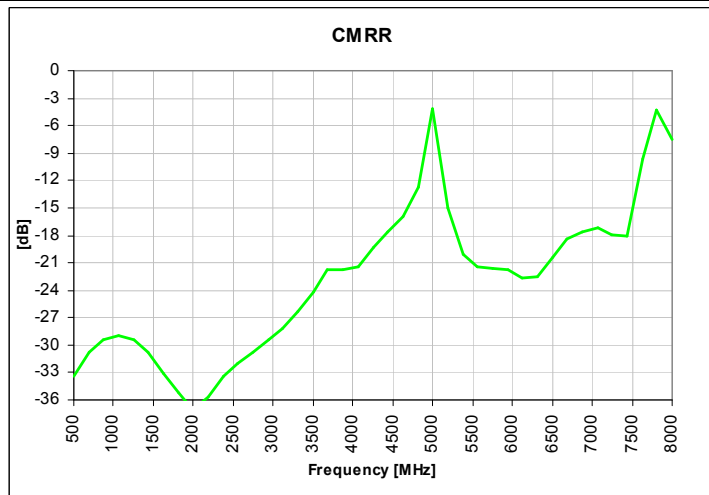
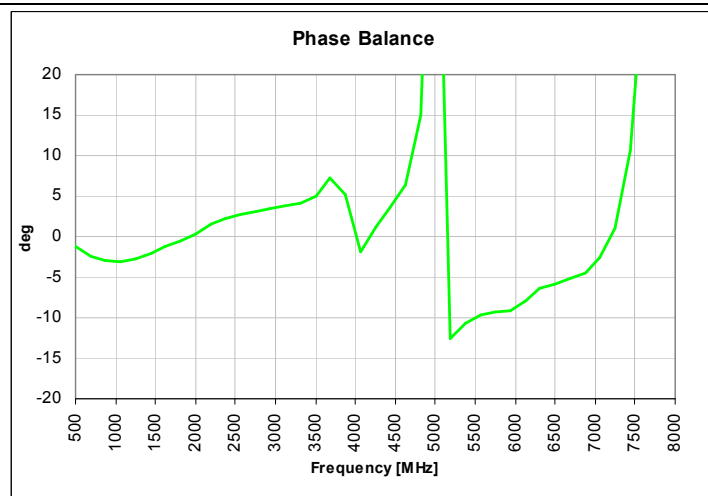
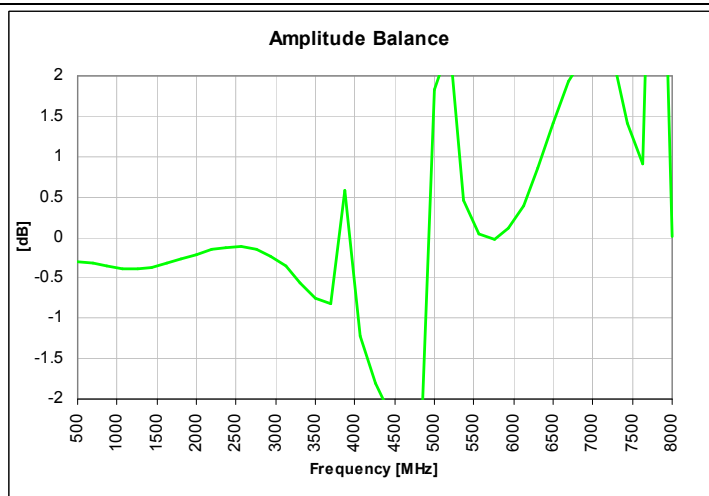
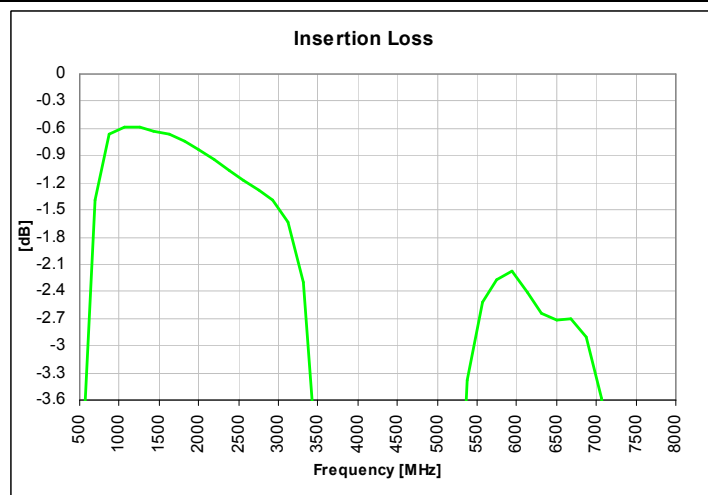
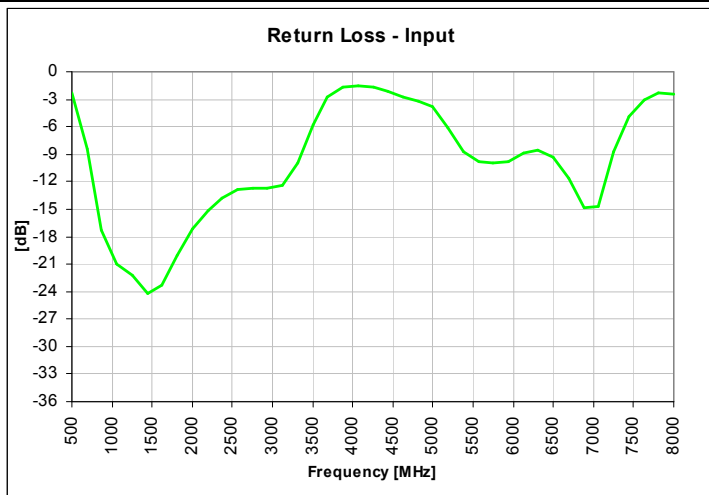

### Typical Performance: 700 MHz. to 2700 MHz.

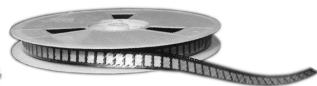
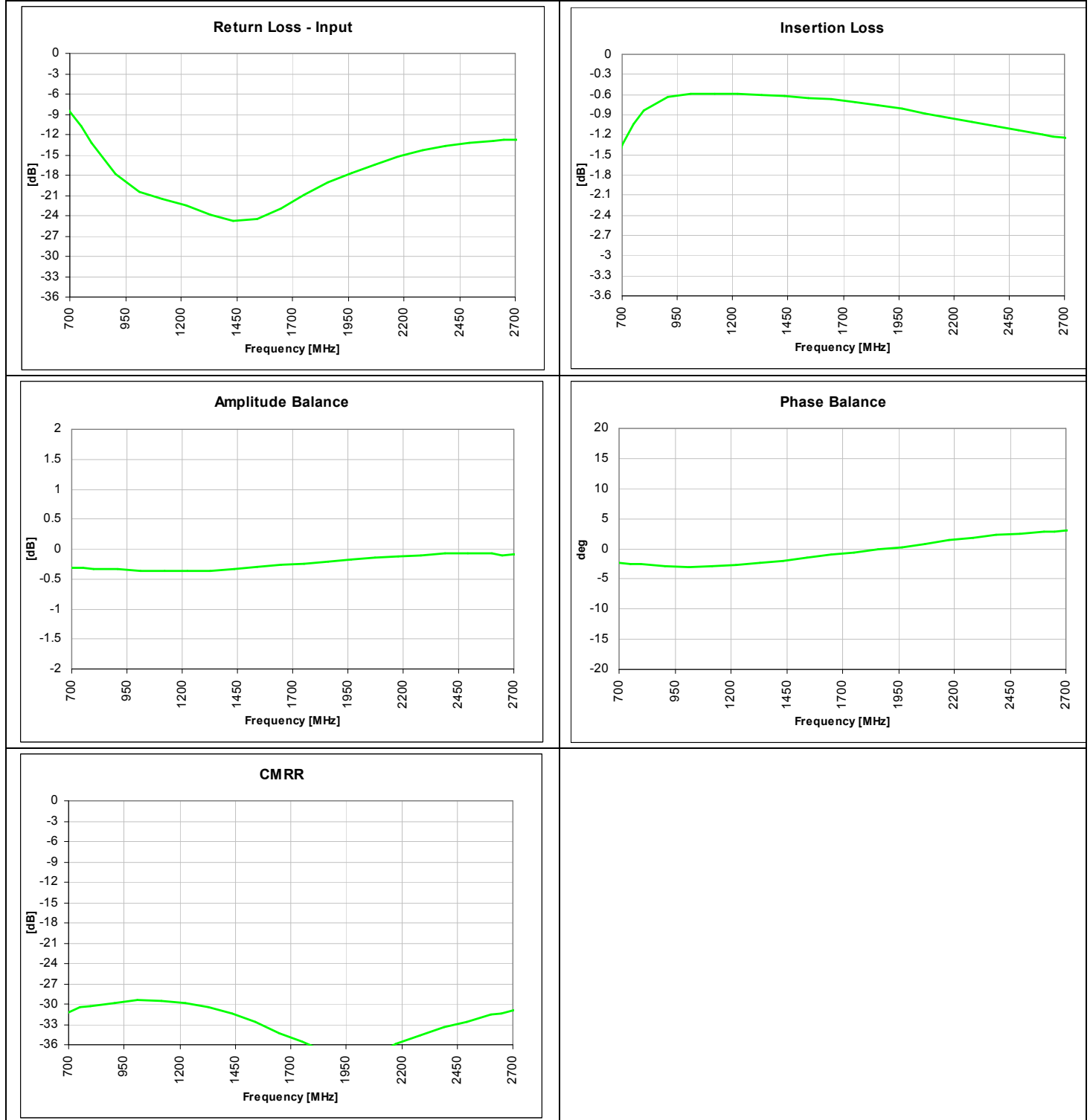

## Mounting Configuration:

In order for Xinger surface mount components to work optimally, the proper impedance transmission lines must be used to connect to the RF ports. If this condition is not satisfied, insertion loss, Isolation and VSWR may not meet published specifications.

All of the Xinger components are constructed from ceramic filled PTFE composites which possess excellent electrical and mechanical stability having X and Y thermal coefficient of expansion (CTE) of 17 ppm/°C.

An example of the PCB footprint used in the testing of these parts is shown below. An example of a DC-biased footprint is also shown below. In specific designs, the transmission line widths need to be adjusted to the unique dielectric coefficients and thicknesses as well as varying pick and place equipment tolerances.

### No Bias Footprint

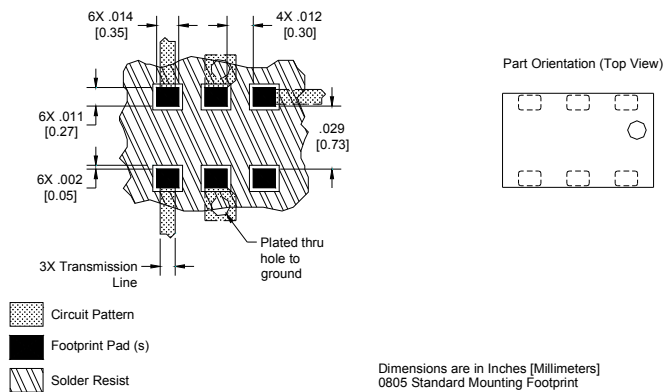

### DC Bias Footprint

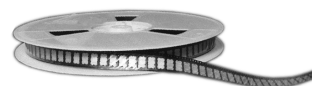
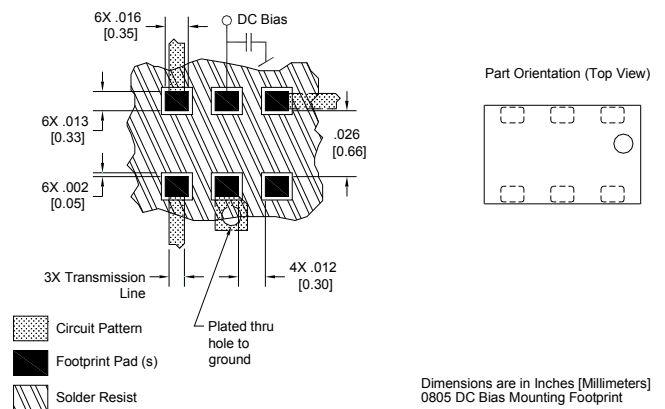

### Packaging and Ordering Information

Parts are available in reel and are packaged per EIA 481-2. Parts are oriented in tape and reel as shown below. Minimum order quantities are 4000 per reel. See Model Numbers below for further ordering information.

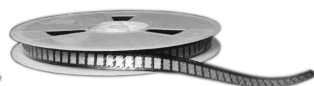
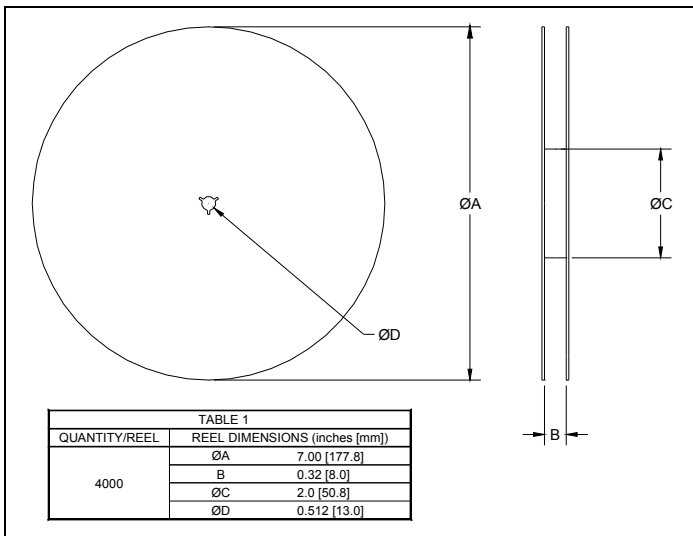
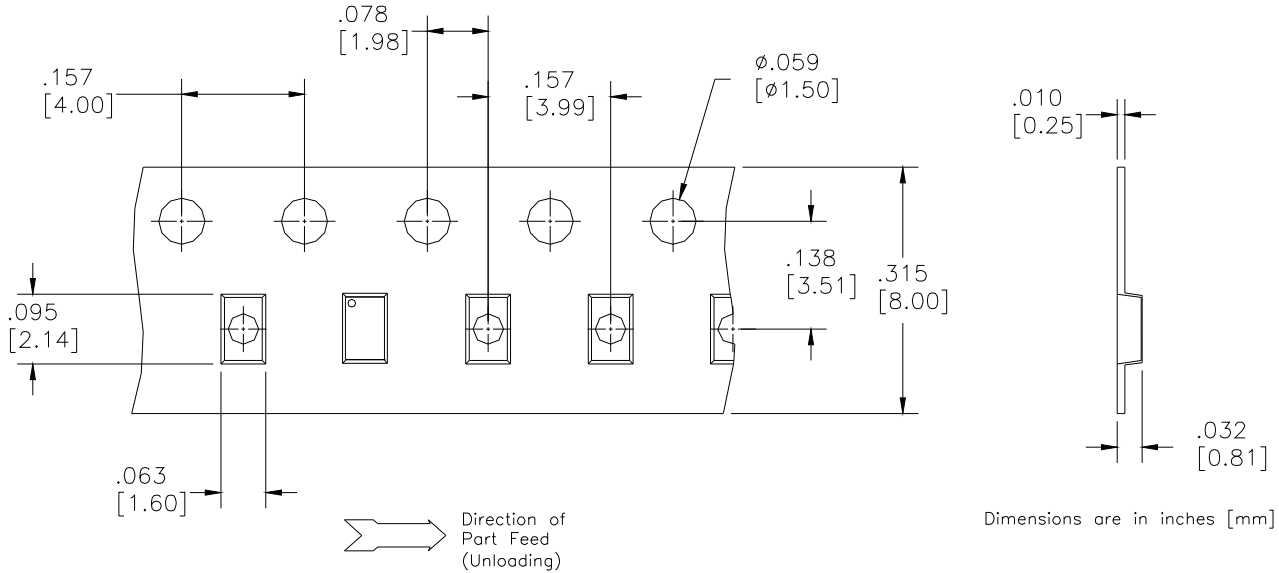

# BD 2425 J 50 100 A 00

| Function                   | Frequency              | Package Dimensions        | Unbalanced Impedance | Balanced Impedance + Coupling | Plating Finish | Codes |
|----------------------------|------------------------|---------------------------|----------------------|-------------------------------|----------------|-------|
| <b>B = Balun</b>           | 0110 = 100 – 1000 MHz  | <b>A = 150 x 150 mils</b> | 50 = 50 Ohm          | 25 = 25 Ω Balanced            | A = Gold       |       |
| <b>BD = Balun + DC</b>     | 0810 = 800 – 1000 MHz  | (4mm x 4mm)               | 75 = 75 Ohm          | 30 = 30 Ω Balanced            | P = Tin-Lead   |       |
| <b>F = Filter</b>          | 0922 = 950 – 2150 MHz  | <b>C = 120 x 120 mils</b> |                      | 50 = 50 Ω Balanced            |                |       |
| <b>FB = Filter / Balun</b> | 0826 = 800 – 6200 MHz  | (3mm x 3mm)               |                      | 75 = 75 Ω Balanced            |                |       |
| <b>C = 3dB Coupler</b>     | 1222 = 1200 – 2200 MHz | <b>E = 100 x 80 mils</b>  |                      | 100 = 100 Ω Balanced          |                |       |
| <b>DC = Directional</b>    | 1416 = 1400 – 1600 MHz | (2.5mm x 2mm)             |                      | 150 = 150 Ω Balanced          |                |       |
| <b>J = RF Jumper</b>       | 1722 = 1700 – 2200 MHz | <b>J = 80 x 50 mils</b>   |                      | 200 = 200 Ω Balanced          |                |       |
| <b>X = RF cross over</b>   | 2326 = 2300 – 2600 MHz | (2mm x 1.25mm)            |                      | 300 = 300 Ω Balanced          |                |       |
|                            | 2425 = 2400 – 2500 MHz | <b>L = 60 x 30 mils</b>   |                      | 400 = 400 Ω Balanced          |                |       |
|                            | 3150 = 3100 – 5000 MHz | (1.5mm x 0.75mm)          |                      | 03 = 3dB Hybrid               |                |       |
|                            | 3436 = 3400 – 3600 MHz | <b>N = 40 x 40 mils</b>   |                      | 10 = 10dB Directional         |                |       |
|                            | 4859 = 4800 – 5900MHz  | (1mm x 1mm)               |                      | 20 = 20dB Directional         |                |       |
|                            | 5153 = 5100 – 5300 MHz |                           |                      |                               |                |       |
|                            | 5159 = 5100 – 5900 MHz |                           |                      |                               |                |       |
|                            | 5759 = 5700 – 5900 MHz |                           |                      |                               |                |       |

USA/Canada: (315) 432-8909  
 Toll Free: (800) 411-6596  
 Europe: +44 2392-232392

Available on Tape and Reel for Pick and Place Manufacturing.

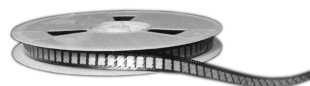

**Anaren**

What'll we think of next?™