



# CONNOR-WINFIELD CORPORATION

AURORA, IL. 60505  
 PHONE (630) 851-4722  
 FAX (630) 851-5040

## 14 PIN DIP PECL

SPECIFICATIONS	EH13-51*	EH13-52*	EH13-53*	EH13-54*
Frequency Range	10MHz to 400MHz			
Frequency Stability	±25ppm	±50ppm	±100ppm	±20ppm
	(Inclusive of calibration tolerance at 25°C, operating temperature range, input voltage change, load change, aging, shock and vibration)			
Temperature Range	0°C to +70°C			
Output	Waveform	PECL Squarewave, 10K Compatible		
	Voltage Voh	3.98 Minimum , 4.26 Maximum		
	Vol	3.05 Minimum , 3.40 Maximum		
	Duty Cycle	45/55 Maximum at 3.67V		
	Rise/Fall Time	2.3nS Maximum		
Output must be terminated into 50 ohms to +3Vdc -OR- 270 ohms to Vee				
Supply Voltage	+5Vdc ±5%			
Supply Current	85mA Maximum			
Package	All metal, hermetically sealed, welded package			
Options *  (add letter to end of model number)	0	Pin 1: No Connection		
	1	Pin 1: Complementary Output		
	2	Pin 1: Enable/Disable Enable; Low Level, Vil (3.40V Max) , Disable; High Level, Vih (3.87V Min) NOTE: When oscillator is disabled the output is in a low state (vol)		

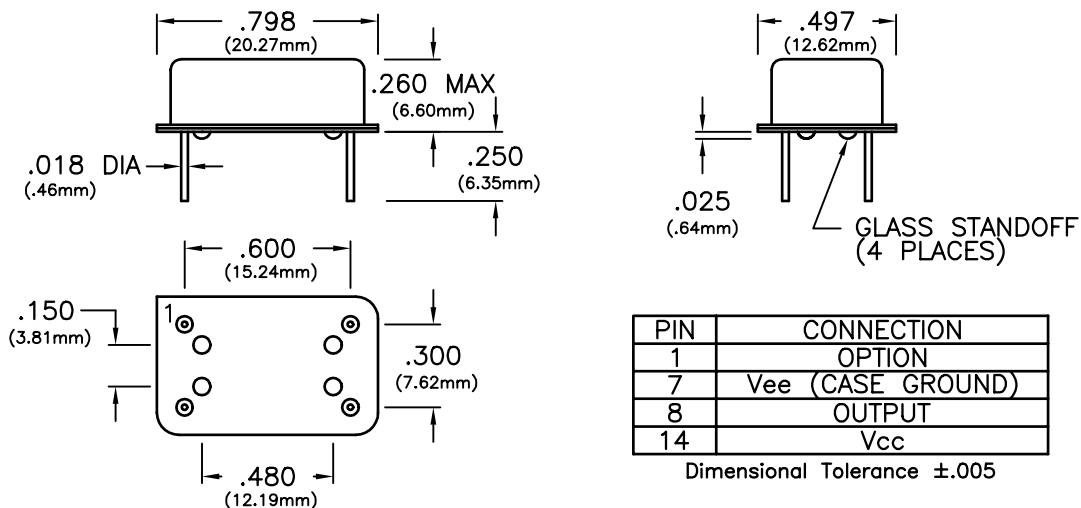

PIN	CONNECTION
1	OPTION
7	Vee (CASE GROUND)
8	OUTPUT
14	Vcc

Dimensional Tolerance ±.005

Specifications subject to change without notice

BULLETIN #: EC052  
 PAGE 1 OF 2

REV: 04  
 DATE: 4/21/95

ISSUED BY: \_\_\_\_\_



# CONNOR-WINFIELD CORPORATION

AURORA, IL. 60505  
 PHONE (630) 851-4722  
 FAX (630) 851-5040

## OUTPUT WAVEFORM

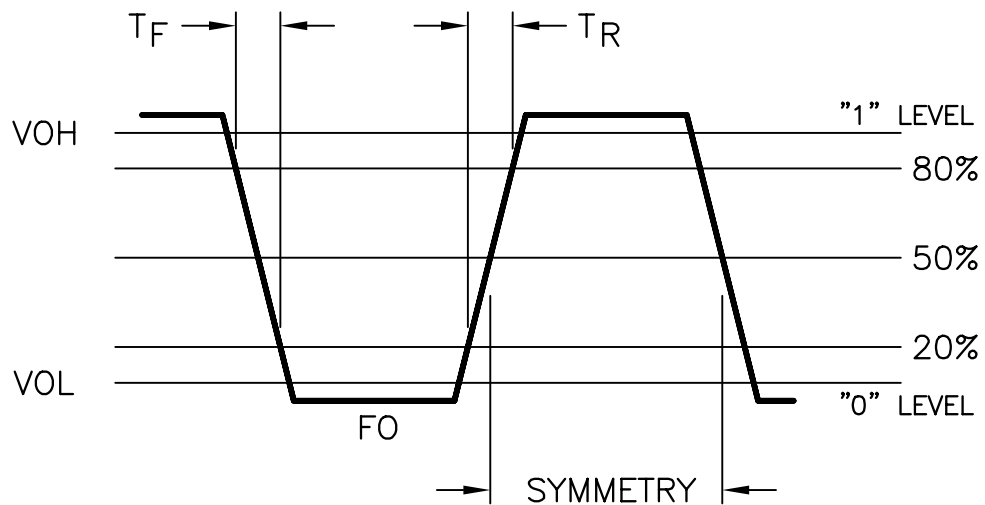

## TEST CIRCUIT

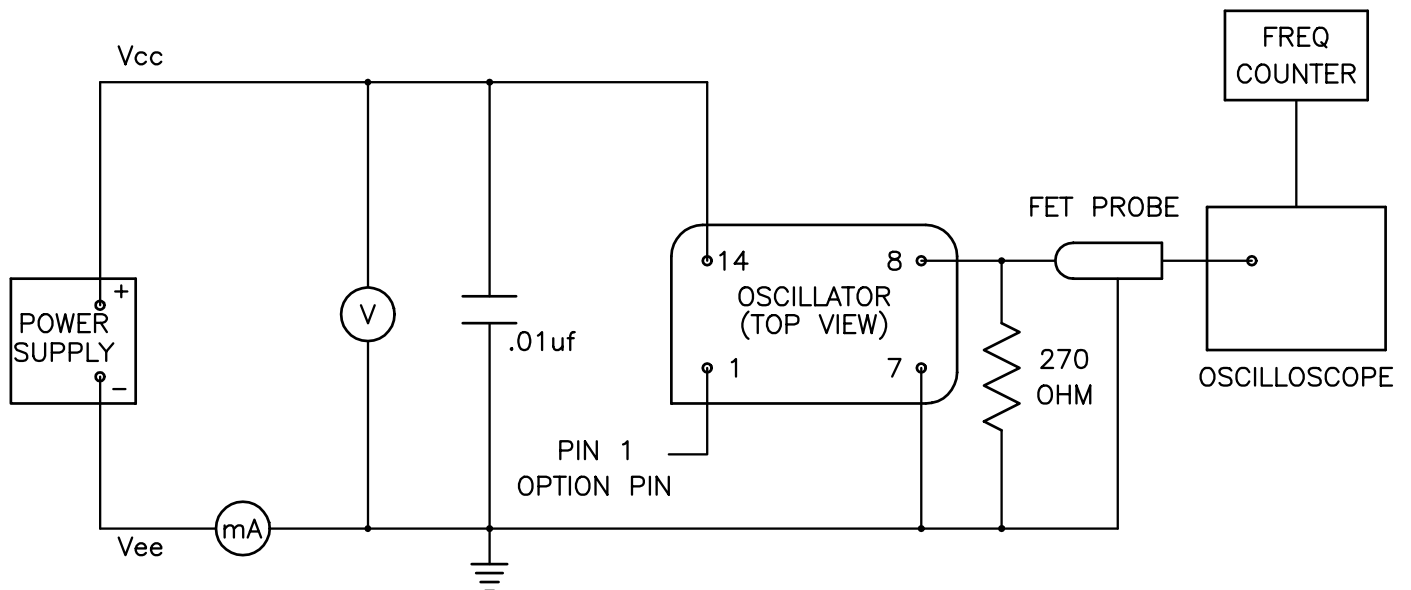

Specifications subject to change without notice

BULLETIN #: EC052  
 PAGE 2 OF 2

REV: 04  
 DATE: 4/21/95

ISSUED BY: \_\_\_\_\_