

Silicon NPN Power Transistors

2SC5287

DESCRIPTION

- With TO-3PN package
- High voltage,high speed switching

APPLICATIONS

- For switching regulator and general purpose applications

PINNING

PIN	DESCRIPTION
1	Base
2	Collector;connected to mounting base
3	Emitter

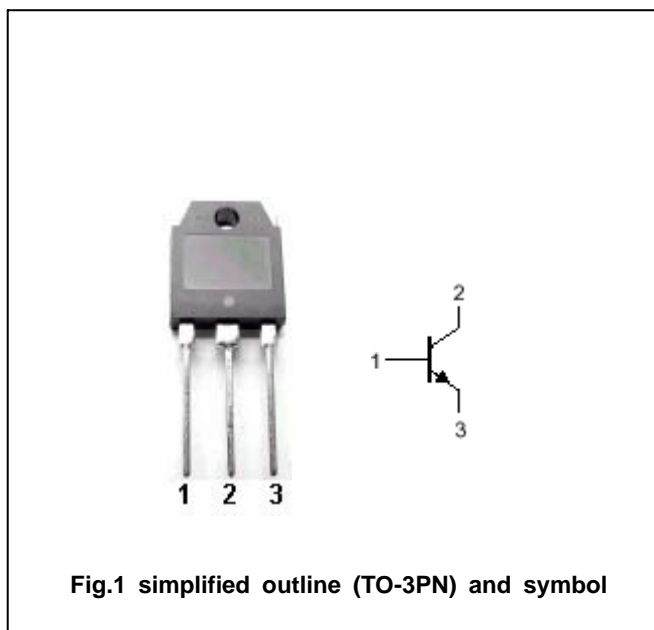

Fig.1 simplified outline (TO-3PN) and symbol

Absolute maximum ratings(Ta= )

SYMBOL	PARAMETER	CONDITIONS	VALUE	UNIT
$V_{CBO}$	Collector-base voltage	Open emitter	900	V
$V_{CEO}$	Collector-emitter voltage	Open base	550	V
$V_{EBO}$	Emitter-base voltage	Open collector	7	V
$I_C$	Collector current		5	A
$I_{CM}$	Collector current-peak		10	A
$I_B$	Base current		2.5	A
$P_C$	Collector power dissipation	$T_C=25$	80	W
$T_j$	Junction temperature		150	
$T_{stg}$	Storage temperature		-55~150	

## Silicon NPN Power Transistors

## 2SC5287

## CHARACTERISTICS

T<sub>j</sub>=25 unless otherwise specified

SYMBOL	PARAMETER	CONDITIONS	MIN	TYP.	MAX	UNIT
V <sub>(BR)CEO</sub>	Collector-emitter breakdown voltage	I <sub>C</sub> =10mA ; I <sub>B</sub> =0	550			V
V <sub>CEsat</sub>	Collector-emitter saturation voltage	I <sub>C</sub> =1.8A; I <sub>B</sub> =0.36A			0.5	V
V <sub>BEsat</sub>	Base-emitter saturation voltage	I <sub>C</sub> =1.8A; I <sub>B</sub> =0.36A			1.2	V
I <sub>CBO</sub>	Collector cut-off current	V <sub>CB</sub> =800V; I <sub>E</sub> =0			100	μ A
I <sub>EBO</sub>	Emitter cut-off current	V <sub>EB</sub> =7V; I <sub>C</sub> =0			100	μ A
h <sub>FE</sub>	DC current gain	I <sub>C</sub> =1.8A ; V <sub>CE</sub> =4V	10		25	
C <sub>OB</sub>	Output capacitance	I <sub>E</sub> =0 ; V <sub>CB</sub> =10V; f=1MHz		50		pF
f <sub>T</sub>	Transition frequency	I <sub>E</sub> =-0.35A ; V <sub>CE</sub> =12V		6		MHz

## Switching times

t <sub>on</sub>	Turn-on time	I <sub>C</sub> =1.8A; R <sub>L</sub> =139 I <sub>B1</sub> =0.27A; I <sub>B2</sub> =-0.9A V <sub>CC</sub> =250V			0.7	μ s
t <sub>s</sub>	Storage time				4.0	μ s
t <sub>f</sub>	Fall time				0.5	μ s

Silicon NPN Power Transistors

2SC5287

PACKAGE OUTLINE

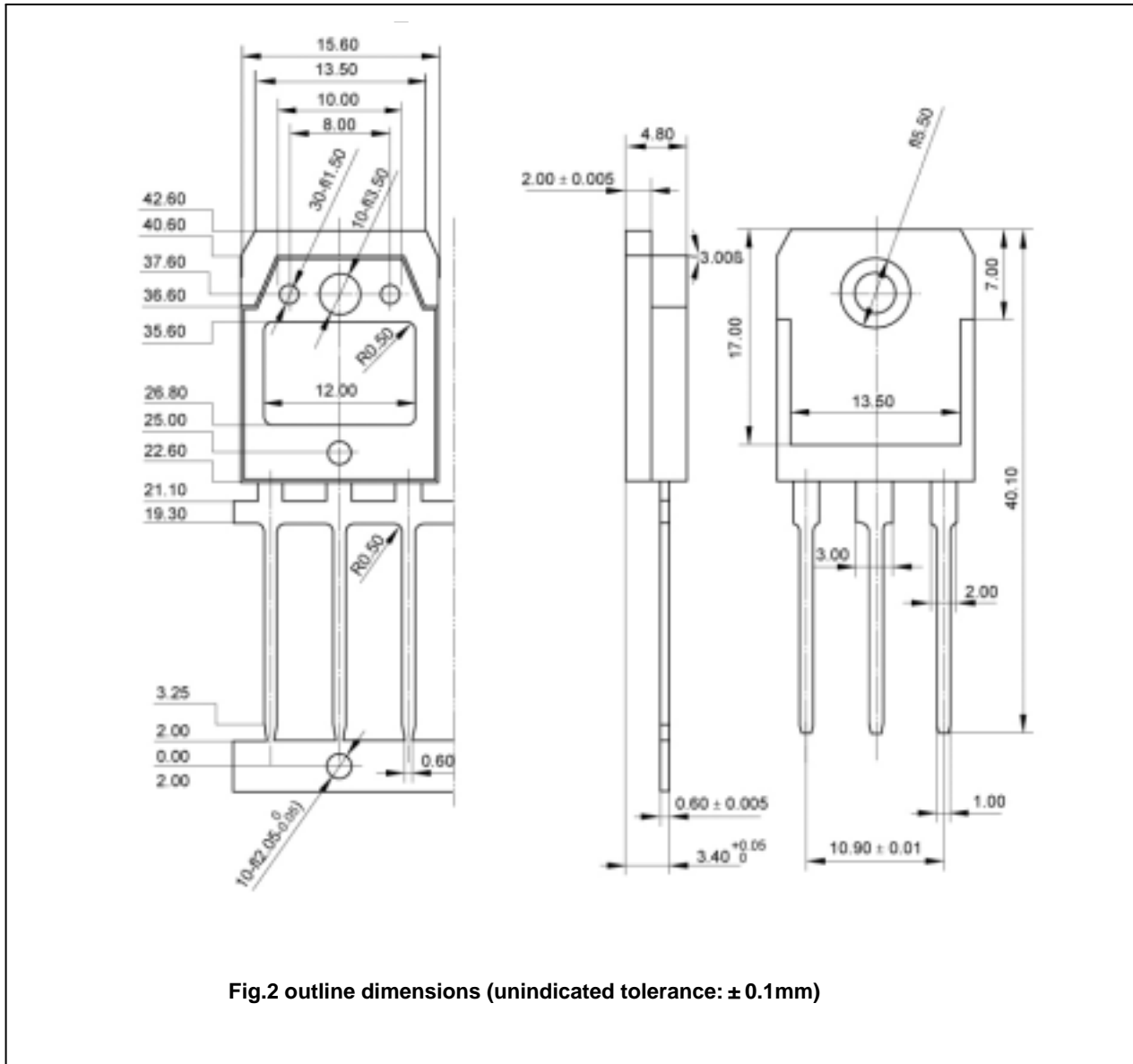

Silicon NPN Power Transistors

2SC5287

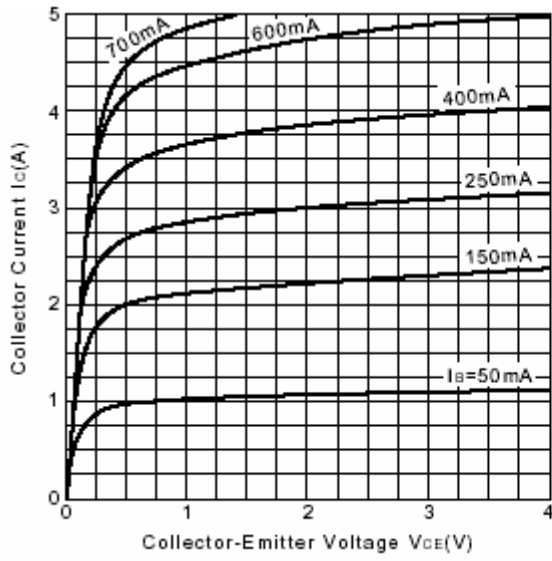

Fig.3 Static Characteristic

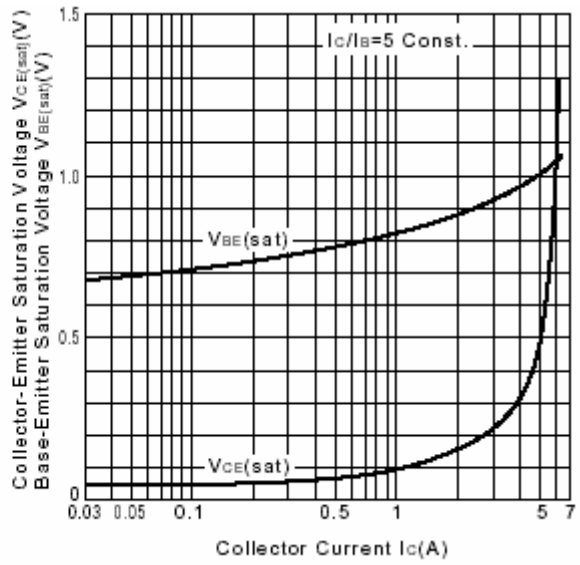

Fig.4 Base-Emitter Saturation Voltage  
Collector-Emitter Saturation Voltage

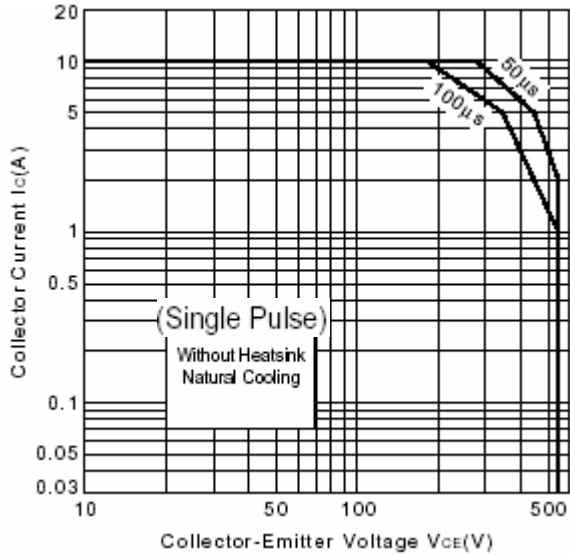

Fig.5 Safe Operating Area

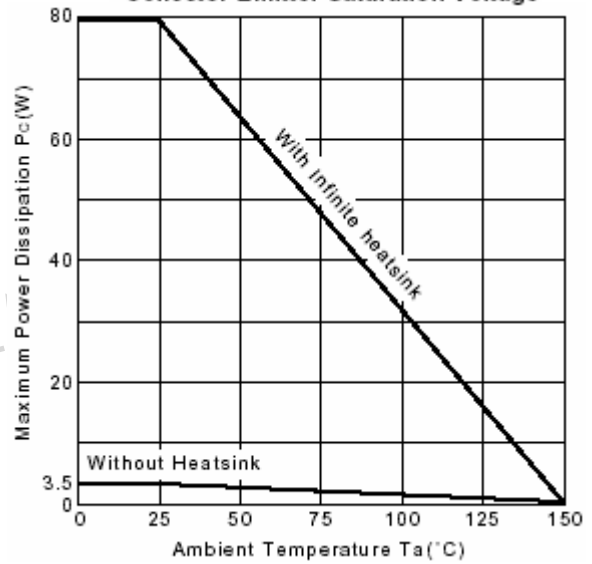

Fig.6 Power Derating

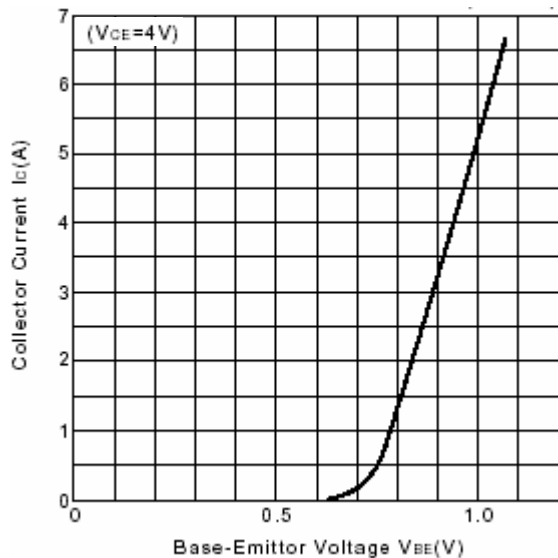

Fig.7  $I_c-V_{BE}$

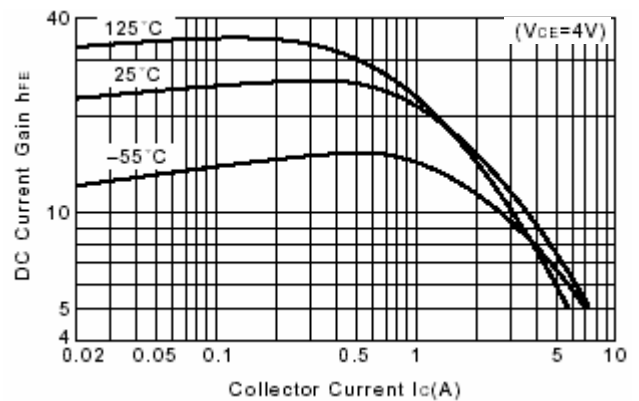

Fig.8 DC current Gain