

Glass Passivated Single-In-Line Bridge Rectifier

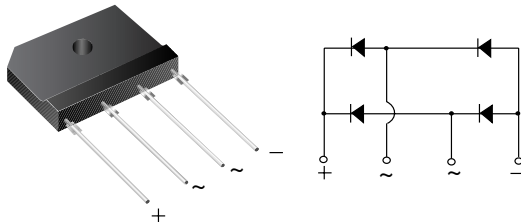

Case Style GSIB-3G

FEATURES

- UL recognition file number E54214
- Ideal for printed circuit boards
- High surge current capability
- High case dielectric strength of 1500 V_{RMS}
- Solder dip 260 °C, 40 s
- Component in accordance to RoHS 2002/95/EC and WEEE 2002/96/EC

RoHS
COMPLIANT

TYPICAL APPLICATIONS

General purpose use in ac-to-dc bridge full wave rectification for monitor, TV, printer, switching mode power supply, adapter, audio equipment, and home appliances applications.

MECHANICAL DATA

Case: GSIB-3G

Epoxy meets UL 94V-0 flammability rating

Terminals: Matte tin plated leads, solderable per J-STD-002 and JESD22-B102

E3 suffix for consumer grade, meets JESD 201 class 1A whisker test

Polarity: As marked on body

Mounting Torque: 10 cm·kg (8.8 inches·lbs) max.

Recommended Torque: 5.7 cm·kg (5 inches·lbs)

PRIMARY CHARACTERISTICS	
$I_{F(AV)}$	4 A
V_{RRM}	200 V to 800 V
I_{FSM}	80 A
I_R	5 μ A
V_F	1.0 V
$T_J \text{ max.}$	150 °C

MAXIMUM RATINGS ($T_A = 25$ °C unless otherwise noted)						
PARAMETER	SYMBOL	GSIB4A20	GSIB4A40	GSIB4A60	GSIB4A80	UNIT
Maximum repetitive peak reverse voltage	V_{RRM}	200	400	600	800	V
Maximum RMS voltage	V_{RMS}	140	280	420	560	V
Maximum DC blocking voltage	V_{DC}	200	400	600	800	V
Maximum average forward rectified output current at $T_C = 100$ °C $T_A = 25$ °C	$I_{F(AV)}$	4.0 ⁽¹⁾ 2.3 ⁽²⁾				A
Peak forward surge current single sine-wave superimposed on rated load	I_{FSM}	80				A
Rating for fusing ($t < 8.3$ ms)	I^2t	32				A ² s
Operating junction and storage temperature range	T_J, T_{STG}	- 55 to + 150				°C

Notes:

(1) Unit case mounted on aluminum plate heatsink

(2) Units mounted on P.C.B. with 0.5 x 0.5" (12 x 12 mm) copper pads and 0.375" (9.5 mm) lead length

ELECTRICAL CHARACTERISTICS ($T_A = 25\text{ }^\circ\text{C}$ unless otherwise noted)							
PARAMETER	TEST CONDITIONS	SYMBOL	GSIB4A20	GSIB4A40	GSIB4A60	GSIB4A80	UNIT
Maximum instantaneous forward drop per diode	2.0 A	V_F			1.00		V
Maximum DC reverse current at rated DC blocking voltage per diode	$T_A = 25\text{ }^\circ\text{C}$ $T_A = 125\text{ }^\circ\text{C}$	I_R			5.0 400		μA

THERMAL CHARACTERISTICS ($T_A = 25\text{ }^\circ\text{C}$ unless otherwise noted)							
PARAMETER	SYMBOL	GSIB4A20	GSIB4A40	GSIB4A60	GSIB4A80	UNIT	
Typical thermal resistance	$R_{\theta JA}$ $R_{\theta JC}$			26 ⁽²⁾ 5 ⁽¹⁾		$^\circ\text{C/W}$	

Noted:

- (1) Unit case mounted on aluminum plate heatsink
- (2) Units mounted on P.C.B. with 0.5 x 0.5" (12 x 12 mm) copper pads and 0.375" (9.5 mm) lead length
- (3) Recommended mounting position is to bolt down on heatsink with silicone thermal compound for maximum heat transfer with #6 screw

ORDERING INFORMATION (Example)				
PREFERRED P/N	UNIT WEIGHT (g)	PREFERRED PACKAGE CODE	BASE QUANTITY	DELIVERY MODE
GSIB4A60-E3/45	4.0	45	20	Tube

RATINGS AND CHARACTERISTICS CURVES

($T_A = 25\text{ }^\circ\text{C}$ unless otherwise noted)

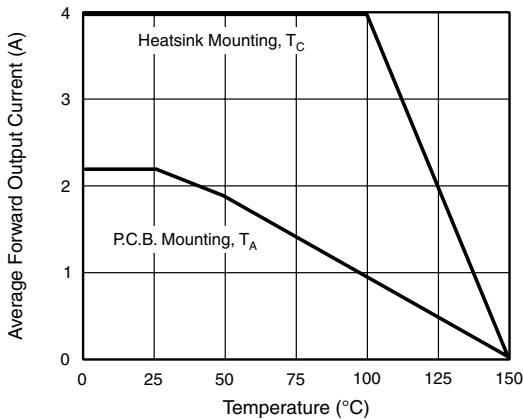

Figure 1. Derating Curve Output Rectified Current

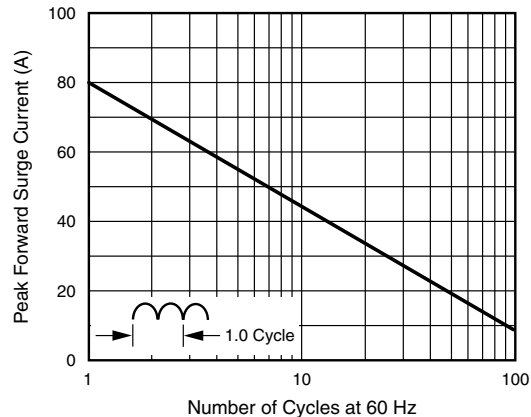

Figure 2. Maximum Non-Repetitive Peak Forward Surge Current Per Diode

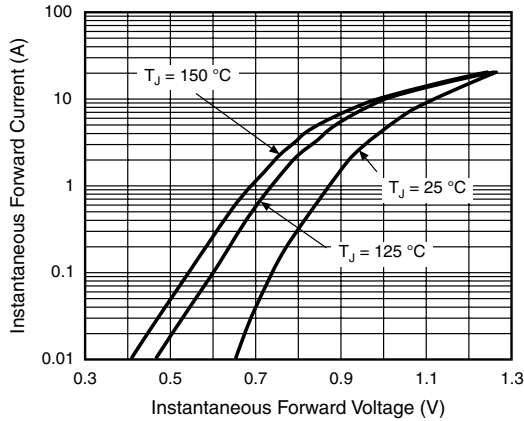

Figure 3. Typical Forward Characteristics Per Diode

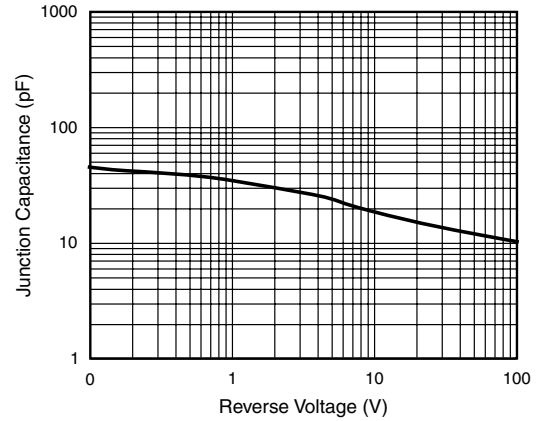

Figure 5. Typical Junction Capacitance Per Diode

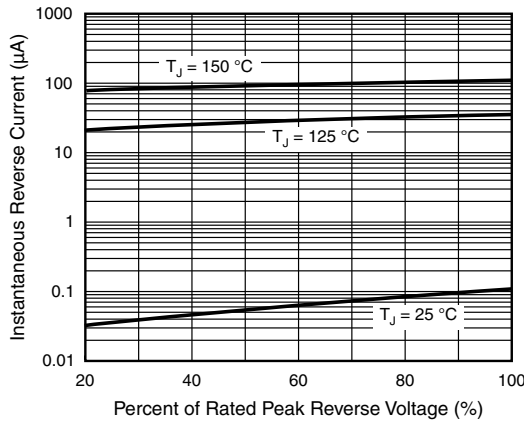

Figure 4. Typical Reverse Characteristics Per Diode

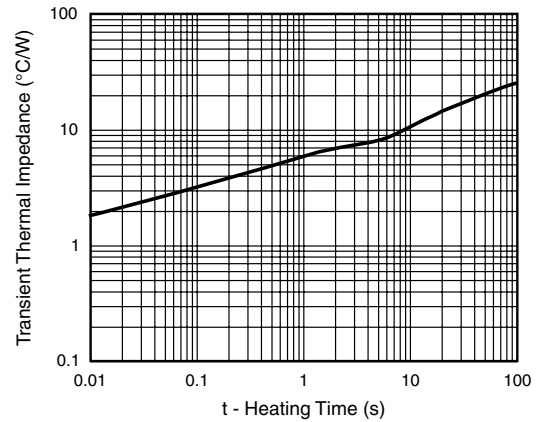
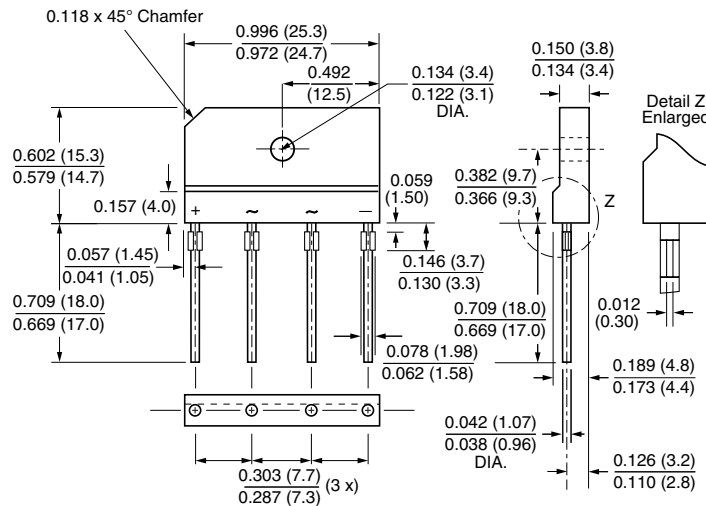

Figure 6. Typical Transient Thermal Impedance Per Diode

PACKAGE OUTLINE DIMENSIONS in inches (millimeters)

Case Style GSIB-3G





Disclaimer

All product specifications and data are subject to change without notice.

Vishay Intertechnology, Inc., its affiliates, agents, and employees, and all persons acting on its or their behalf (collectively, "Vishay"), disclaim any and all liability for any errors, inaccuracies or incompleteness contained herein or in any other disclosure relating to any product.

Vishay disclaims any and all liability arising out of the use or application of any product described herein or of any information provided herein to the maximum extent permitted by law. The product specifications do not expand or otherwise modify Vishay's terms and conditions of purchase, including but not limited to the warranty expressed therein, which apply to these products.

No license, express or implied, by estoppel or otherwise, to any intellectual property rights is granted by this document or by any conduct of Vishay.

The products shown herein are not designed for use in medical, life-saving, or life-sustaining applications unless otherwise expressly indicated. Customers using or selling Vishay products not expressly indicated for use in such applications do so entirely at their own risk and agree to fully indemnify Vishay for any damages arising or resulting from such use or sale. Please contact authorized Vishay personnel to obtain written terms and conditions regarding products designed for such applications.

Product names and markings noted herein may be trademarks of their respective owners.