

Fully Sealed Container Square or Round Cermet Trimmers

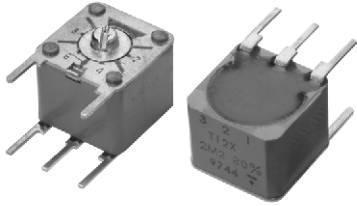

The Vishay SFERNICE trimming potentiometers T12 and T13 fully meet the requirements of CECC 41 100.

The use of a cermet track combined with sealing of the case provides unique characteristics and performances.

T12 and T13 have been specially designed for mounting on printed circuit board.

FEATURES

- Military and Professional Grade
- High power rating (1 Watt at 70 °C)
- CECC 41100
- High stability (1 % typical)
- Mechanical strength
- Hermetic sealing of the case
- Different mounting types



DIMENSIONS in millimeters

T12X - PM06X

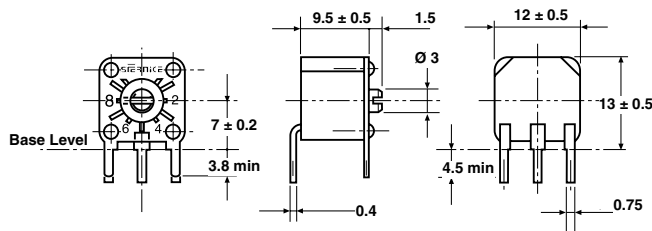

T12Y - PM06Y

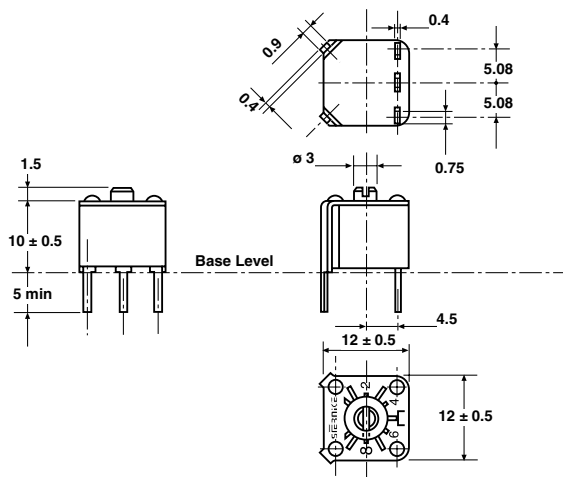

T13Y

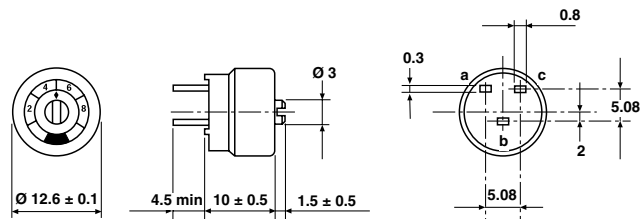

TERMINAL SPACING ON THE PCB Drilling diameter: 1.2 mm

T12X

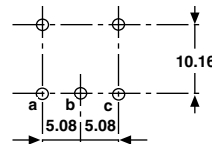

T12Y

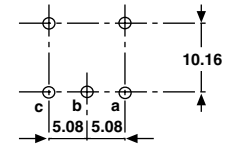

CIRCUIT DIAGRAM

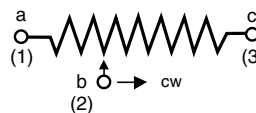

LOCKING DEVICE: T12 XB - YB

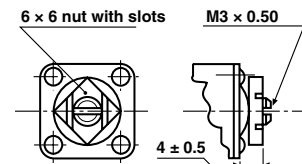

Tolerances unless otherwise specified ± 0.5



ELECTRICAL SPECIFICATIONS		
Resistive Element		cermet
Electrical Travel		270° ± 10°
Resistance Range		22 Ω to 10 MΩ
Standard series E3		1 - 2.2 - 4.7 and on request 1 - 2 - 5
Tolerance	Standard	± 20 %
	On Request	± 10 %
Power Rating	Linear	1 W at 70 °C
	Logarithmic	0.5 W at 70 °C
Temperature Coefficient		See Standard Resistance Element Table
Limiting Element Voltage (Linear Law)		350 V
Contact Resistance Variation		3 % Rn or 3 Ω
End Resistance (Typical)		1 Ω
Dielectric Strength (RMS)		1000 V
Insulation Resistance (500VDC)		10 ⁶ MΩ

MECHANICAL SPECIFICATIONS

Mechanical Travel 300° ± 5°
 Operating Torque (max. Ncm) 3
 End Stop Torque (max. Ncm) 15
 Unit Weight (max. g) 4.7

ENVIRONMENTAL SPECIFICATIONS

Temperature Range - 55 °C to + 125 °C
 Climatic Category 55/100/56
 Sealing fully sealed container IP67

POWER RATING CHART

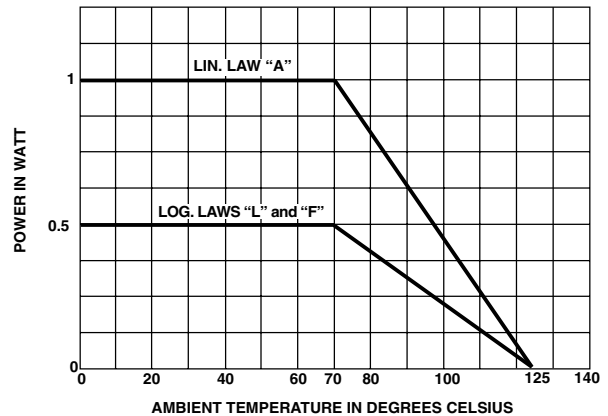

RESISTANCE LAWS

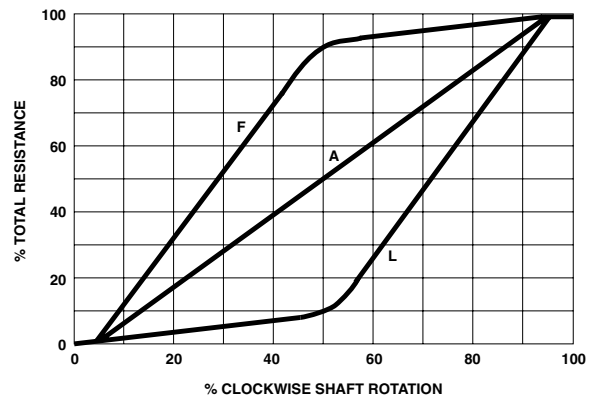



PERFORMANCE			
TESTS	CONDITIONS	TYPICAL VALUES AND DRIFTS	
		$\frac{\Delta RT}{RT}$ (%)	$\frac{\Delta R_{1-2}}{R_{1-2}}$ (%)
Load Life	1000 hours at rated power 90°/30° - ambient temperature 70 °C	± 1 % Contact res. variation: < 2 % Rn	± 2 %
Climatic Sequence	Phase A dry heat 100 °C Phase B damp heat Phase C cold - 55 °C Phase D damp heat 5 cycles	± 0.5 %	± 1 %
Long Term Damp Heat	56 days 40 °C 93 % RH	± 0.5 % Dielectric strength: 1000 V RMS Insulation resistance: > 10 ⁴ MΩ	± 1 %
Rapid Temperature Change	5 cycles - 55 °C at + 125 °C	± 0.5 %	$\frac{\Delta V_{1-2}}{\Delta V_{1-3}}$ ≤ ± 1 %
Shock	50 g at 11 m secs 3 successive shocks in 3 directions	± 0.1 %	± 0.5 %
Vibration	10 - 55 Hz 0.75 mm or 10 g during 6 hours	± 0.1 %	$\frac{\Delta V_{1-2}}{\Delta V_{1-3}}$ ≤ ± 0.5 %
Rotational Life	200 cycles	± 1 % Contact res. variation: < 2 % Rn	

STANDARD RESISTANCE ELEMENT DATA							
STANDARD RESISTANCE VALUES	LINEAR LAW			LOG LAWS			TCR - 55 °C + 125 °C ppm/°C
	MAX. POWER AT 70 °C	MAX. WORKING VOLTAGE	MAX. WIPER CUR.	MAX. POWER AT 70 °C	MAX. WORKING VOLTAGE	MAX. WIPER CUR.	
Ω	W	V	mA	W	V	mA	
22	1	4.69	213.2				0
47	↓	6.85	145.8				+ 200
100	↓	10	100				± 100
220	↓	14.8	67.4				
470	↓	21.6	46.1				
1K	↓	31.6	31.6	0.5	22.4	22.4	
2.2K	↓	46.9	21.3	↓	33.2	15.1	
4.7K	↓	68.5	14.5	↓	48.5	10.3	
10K	↓	100	10	↓	79.7	7.07	
22K	↓	148.3	6.7	↓	105	4.77	
47K	↓	216.7	4.6	↓	153	3.26	
100K	1	316.2	3.16	↓	224	2.24	
220K	0.56	350	1.59	0.5	332	1.51	
470K	0.26	350	0.75	0.26	350	0.74	
1M	0.12	350	0.35	0.12	350	0.35	
2.2M	0.05	350	0.16				
4.7M	0.02	350	0.07				
10M	0.01	350	0.03				

MARKING

Printed:

- VISHAY trademark
- series
- ohmic value (in Ω, kΩ, MΩ)
- tolerance (in %)
- manufacturing date
- marking of terminal: (1, 2, 3)



PACKAGING

- Plastic box of 50 pieces for T13Y and BL50
- Carton box of 50 pieces for T12Y and T12X, code BO50

ORDERING INFORMATION

T12 SERIES	X STYLE	B ON REQUEST	22 kΩ OHMIC VALUE	± 20 % TOLERANCE	A RESISTANC	BO50 PACKAGING	e3 LEAD FINISH
T12	X	LOCKING DEVICE			LAWS	Version T12X, Y: BO50	
T13	Y					Version T13Y: BL50	e3: pure Sn

SAP PART NUMBERING GUIDELINES

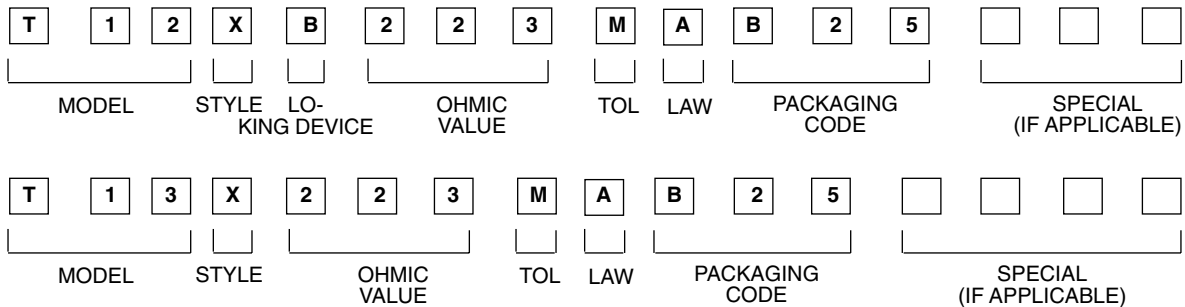

See the end of this data book for conversion tables



Disclaimer

All product specifications and data are subject to change without notice.

Vishay Intertechnology, Inc., its affiliates, agents, and employees, and all persons acting on its or their behalf (collectively, "Vishay"), disclaim any and all liability for any errors, inaccuracies or incompleteness contained herein or in any other disclosure relating to any product.

Vishay disclaims any and all liability arising out of the use or application of any product described herein or of any information provided herein to the maximum extent permitted by law. The product specifications do not expand or otherwise modify Vishay's terms and conditions of purchase, including but not limited to the warranty expressed therein, which apply to these products.

No license, express or implied, by estoppel or otherwise, to any intellectual property rights is granted by this document or by any conduct of Vishay.

The products shown herein are not designed for use in medical, life-saving, or life-sustaining applications unless otherwise expressly indicated. Customers using or selling Vishay products not expressly indicated for use in such applications do so entirely at their own risk and agree to fully indemnify Vishay for any damages arising or resulting from such use or sale. Please contact authorized Vishay personnel to obtain written terms and conditions regarding products designed for such applications.

Product names and markings noted herein may be trademarks of their respective owners.