

### PRELIMINARY SPEC

Part Number: AA3020ARWC/Z

WHITE



**ATTENTION**  
OBSERVE PRECAUTIONS  
FOR HANDLING  
ELECTROSTATIC  
DISCHARGE  
SENSITIVE  
DEVICES

### Features

- 3.0MM X 2.0MM, 1.4MM HIGH, ONLY MINIMUM SPACE REQUIRED.
- SUITABLE FOR COMPACT OPTOELECTRONIC APPLICATIONS.
- LOW POWER CONSUMPTION.
- PACKAGE : 2000PCS / REEL.
- MOISTURE SENSITIVITY LEVEL : LEVEL 4.
- ELECTROSTATIC DISCHARGE THRESHOLD (HBM):1000V.
- TYP. COLOR TEMPERATURE: 6500K
- COLOR COORDINATES:X=0.31,Y=0.31 ACC. TO CIE1931(WHITE).
- OPTICAL EFFICIENCY: 51.6 lm/W(TYP.)
- COLOR REPRODUCTION INDEX: 80
- RoHS COMPLIANT.

### Description

The source color devices are made with InGaN Light Emitting Diode.

Static electricity and surge damage the LEDs.

It is recommended to use a wrist band or anti-electrostatic glove when handling the LEDs.

All devices, equipment and machinery must be electrically grounded.

### Applications

- traffic signaling.
- backlighting (illuminated advertising , general lighting).
- interior and exterior automotive lighting.
- substitution of micro incandescent lamps.
- reading lamps.
- signal and symbol luminaire for orientation.
- marker lights (e.g. steps, exit ways, etc).
- decorative and entertainment lighting.
- indoor and outdoor commercial and residential architectural lighting.

### Package Dimensions

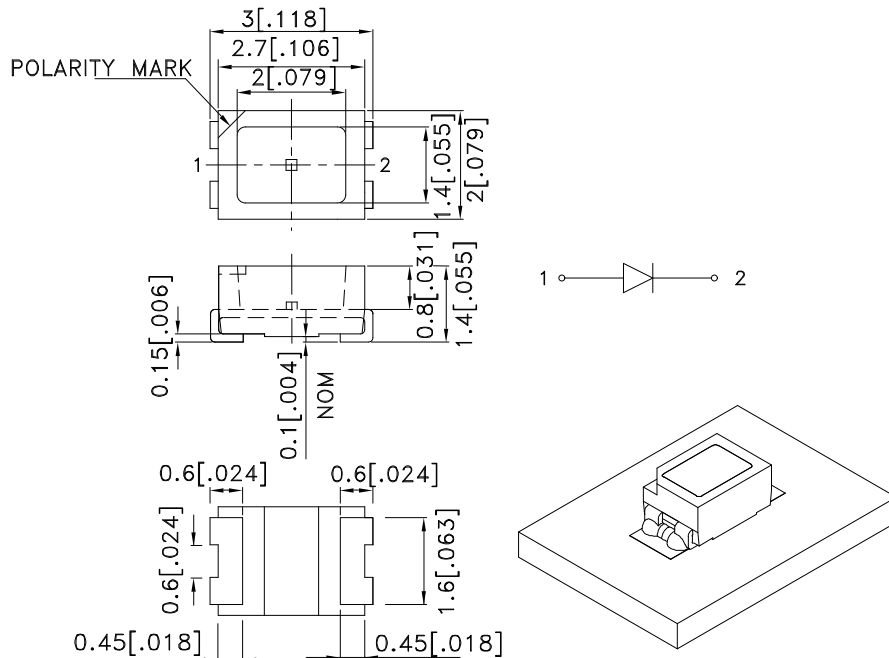

#### Notes:

1. All dimensions are in millimeters (inches).
2. Tolerance is  $\pm 0.25(0.01")$  unless otherwise noted.
3. Specifications are subject to change without notice.
4. The device has a single mounting surface. The device must be mounted according to the specifications.



## Handling Precautions

Compare to epoxy encapsulant that is hard and brittle, silicone is softer and flexible. Although its characteristic significantly reduces thermal stress, it is more susceptible to damage by external mechanical force.

As a result, special handling precautions need to be observed during assembly using silicone encapsulated LED products. Failure to comply might leads to damage and premature failure of the LED.

1. Handle the component along the side surfaces by using forceps or appropriate tools.

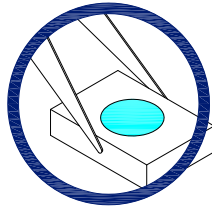

2. Do not directly touch or handle the silicone lens surface. It may damage the internal circuitry.

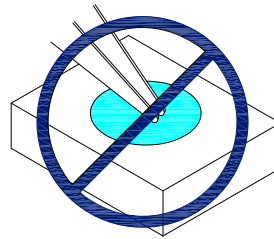
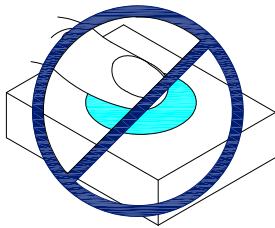

3. Do not stack together assembled PCBs containing exposed LEDs. Outside impact may scratch the silicone lens or damage the internal circuitry.

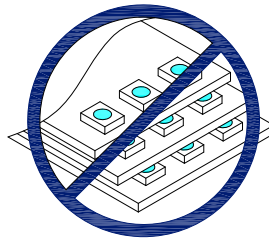

4. During surface-mounting, the pickup capillary diameter should be larger than the silicone lens to insure the capillary does not scratch or damage the lens.

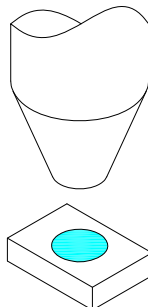

## Selection Guide

Part No.	Dice	Lens Type	Luminous Intensity <sup>Note2</sup> Iv(mcd) @ 20mA		Φv (mlm) <sup>Note3</sup> @ 20mA		Viewing Angle <sup>Note1</sup>
			Min.	Typ.	Min.	Typ.	2 θ 1/2
AA3020ARWC/Z	WHITE (InGaN)	WATER CLEAR	650	1200	1500	3300	120 °

## Absolute Maximum Ratings at TA=25°C

Parameter	Symbol	Value	Unit
Power dissipation	Pt	111	mW
Reverse Voltage	VR	5	V
Junction temperature	TJ	110	°C
Operating Temperature	Top	-40 To +85	°C
Storage Temperature	Tstg	-40 To +100	°C
DC Forward Current	IF	30	mA
Peak Forward Current <sup>Note4</sup>	IFM	100	mA
Thermal resistance Junction/ambient <sup>Note5</sup>	Rth JA	300	°C/W
Junction/solder point	Rth JS	140	°C/W

### Notes:

- θ 1/2 is the angle from optical centerline where the luminous intensity is 1/2 the optical centerline value.
- Luminous intensity is measured by a current pulse of 10ms at a tolerance of ±15%.
- The typical data of Luminous Flux can only reflect statistical figures, actual parameters of individual product could differ from the typical data. For the purpose of product enhancement, the typical data is subject to change without prior notice.
- 1/10 Duty Cycle, 0.1ms Pulse Width.
- Rth(J-A) Results from mounting on PC board FR4 (pad size ≥ 16 mm<sup>2</sup> per pad),

## Electrical / Optical Characteristics at TA=25°C

Parameter	Symbol	Value	Unit
Chromaticity coordinate x acc.to CIE1931 IF=20mA [Typ.]	X <sup>Note1</sup>	0.31	-
Chromaticity coordinate y acc.to CIE1931 IF=20mA [Typ.]	Y <sup>Note1</sup>	0.31	-
Forward Voltage IF=20mA [Min.]	VF <sup>Note2</sup>	2.7	V
Forward Voltage IF=20mA [Typ.]		3.2	
Forward Voltage IF=20mA [Max.]		3.7	
Reverse Current (VR=5V) [Typ.]	IR	0.01	μ A
Reverse Current (VR=5V) [Max.]		10	
Temperature coefficient of x IF=20mA, -10 ° C ≤ T ≤ 100 ° C [Typ.]	TCx	-0.1	10 <sup>-3</sup> /° C
Temperature coefficient of y IF=20mA, -10 ° C ≤ T ≤ 100 ° C [Typ.]	TCy	-0.2	10 <sup>-3</sup> /° C
Temperature coefficient of VF IF=20mA, -10 ° C ≤ T ≤ 100 ° C [Typ.]	TCv	-2.5	mV/° C

### Notes:

- Chromaticity coordinates are measured by a current pulse of 20ms with a tolerance of ±0.01 in X and Y color coordinates.
- Forward voltage is measured with a current pulse of 10ms at a tolerance of ±0.1V.

## Brightness codes

luminous Intensity <sup>Note1</sup> Iv(mcd) @ 20mA			$\Phi_v$ (mlm) <sup>Note2</sup> @ 20mA
Code.	Min.	Max.	Typ.
T	650	1200	3260
U	900	1500	3350
V	1200	1800	3400

**Notes:**

- Luminous intensity is measured by a current pulse of 10ms at a tolerance of  $\pm 15\%$ .
- The typical data of Luminous Flux can only reflect statistical figures, actual parameters of individual product could differ from the typical data. For the purpose of product enhancement, the typical data is subject to change without prior notice.

## White

### AA3020ARWC/Z

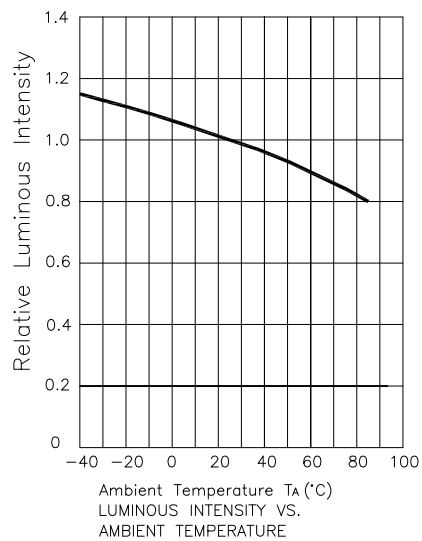
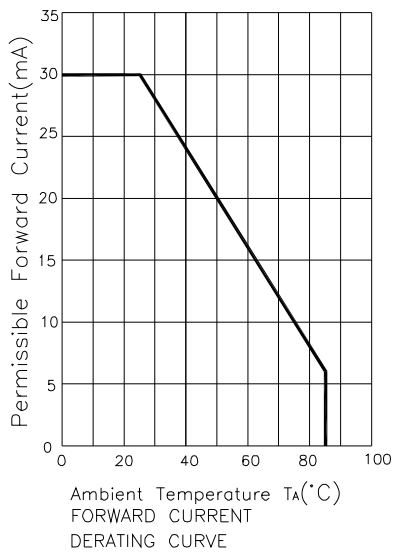
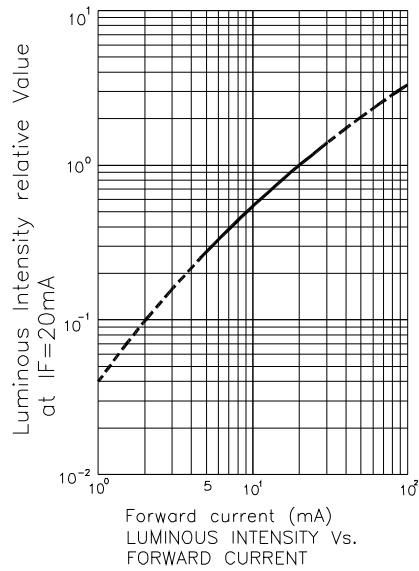
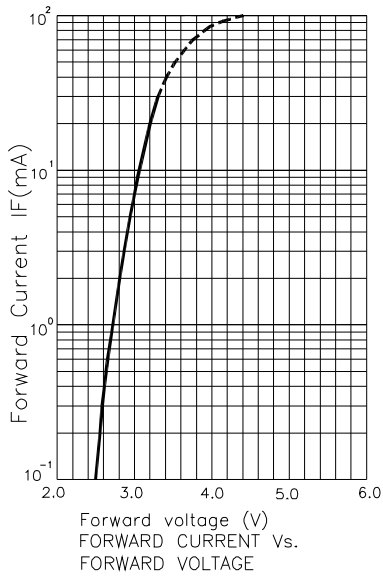

## AA3020ARWC/Z

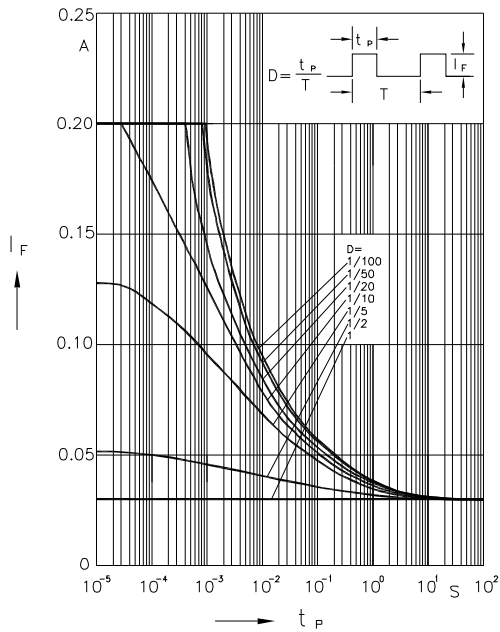

Permissible Pulse Handling Capability  
Duty cycle  $D = \text{parameter}$ ,  $T_A = 25^\circ\text{C}$

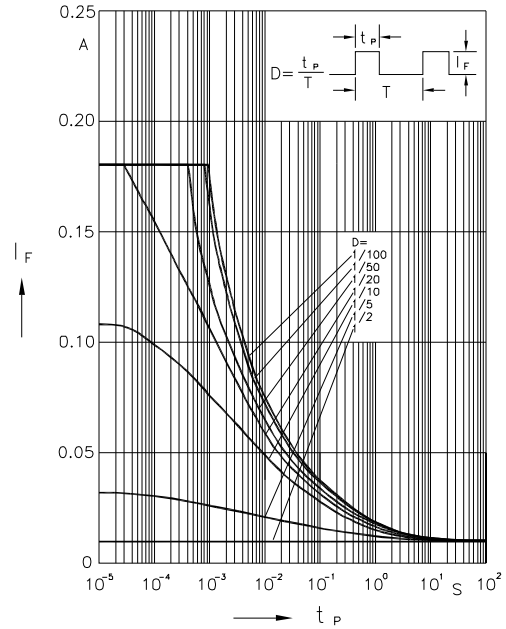

Permissible Pulse Handling Capability  
Duty cycle  $D = \text{parameter}$ ,  $T_A = 85^\circ\text{C}$

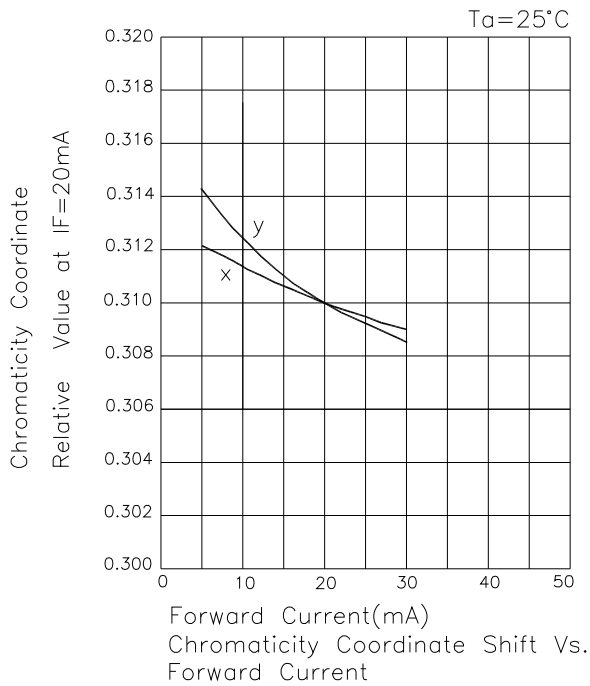

Forward Current (mA)  
Chromaticity Coordinate Shift Vs. Forward Current

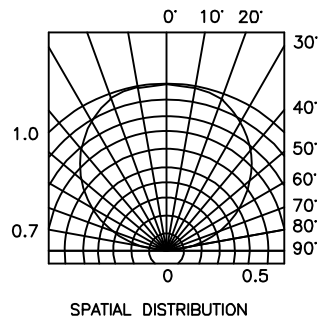
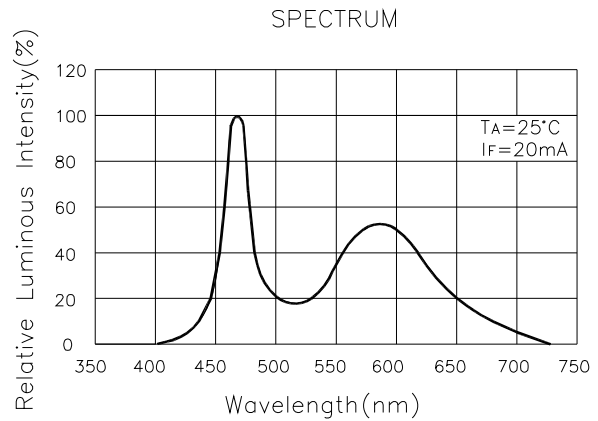

AA3020ARWC/Z

## White CIE

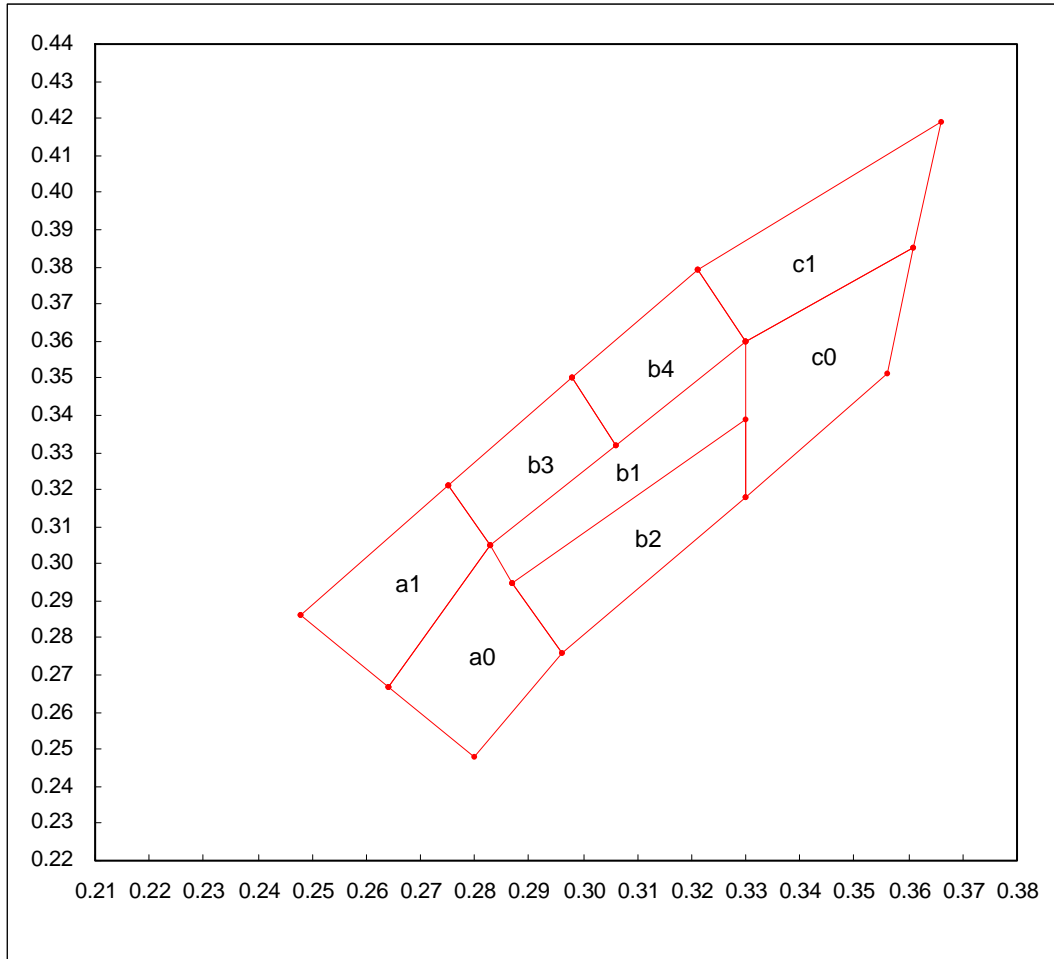

a0				
X	0.264	0.283	0.296	0.280
Y	0.267	0.305	0.276	0.248
Reference CCT: 14000~9000k				

a1				
X	0.248	0.275	0.283	0.264
Y	0.286	0.321	0.305	0.267
Reference CCT: 14000~9000k				

b1				
X	0.283	0.330	0.330	0.287
Y	0.305	0.360	0.339	0.295
Reference CCT: 9000~5600k				

b2				
X	0.287	0.330	0.330	0.296
Y	0.295	0.339	0.318	0.276
Reference CCT: 9000~5600k				

b3				
X	0.275	0.298	0.306	0.283
Y	0.321	0.350	0.332	0.305
Reference CCT: 9000~7000k				

b4				
X	0.298	0.321	0.330	0.306
Y	0.350	0.379	0.360	0.332
Reference CCT: 7600~5600k				

c0				
X	0.330	0.361	0.356	0.330
Y	0.360	0.385	0.351	0.318
Reference CCT: 5600~4600k				

c1				
X	0.321	0.366	0.361	0.330
Y	0.379	0.419	0.385	0.360
Reference CCT: 6000~4600k				

## AA3020ARWC/Z

Reflow Soldering Profile For Lead-free SMT Process.

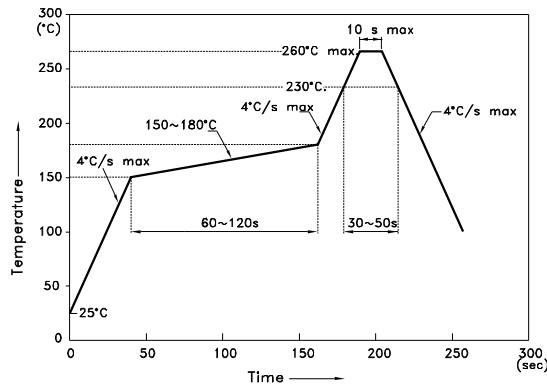

NOTES:

1. We recommend the reflow temperature 245°C(+/-5°C). The maximum soldering temperature should be limited to 260°C.
2. Don't cause stress to the epoxy resin while it is exposed to high temperature.
3. Number of reflow process shall be 2 times or less.

### Recommended Soldering Pattern (Units : mm; Tolerance: ± 0.1)

Pad design for improved heat dissipation

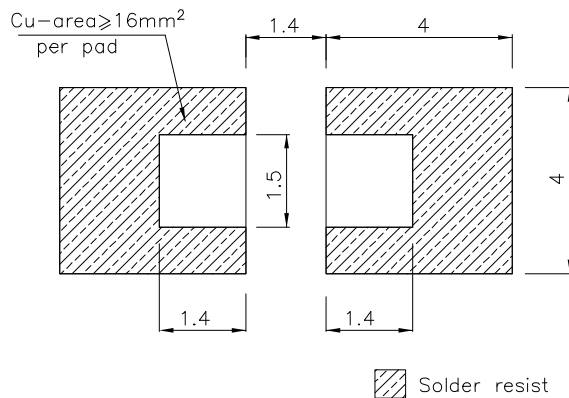
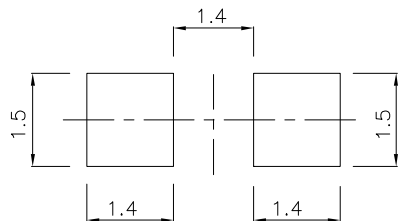

### Tape Specifications (Units : mm)

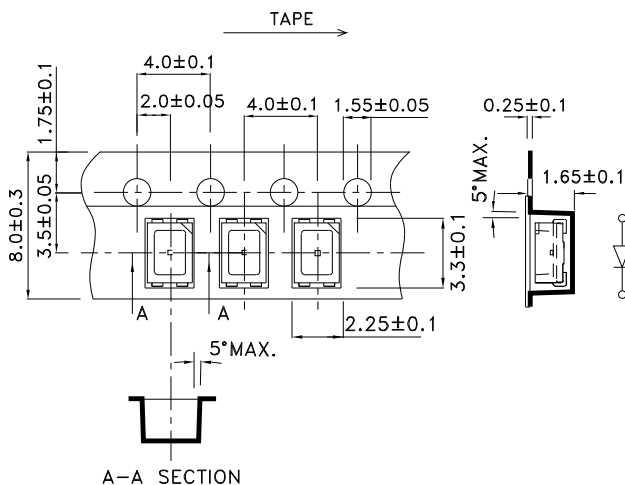

### Reel Dimension

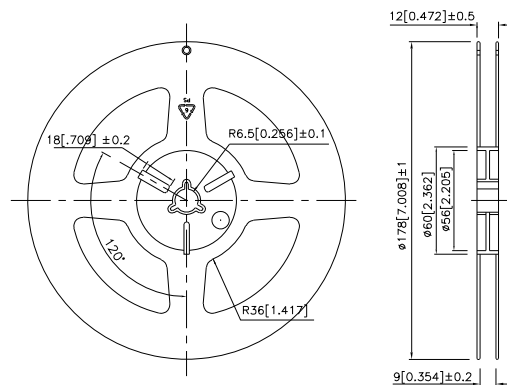

# Kingbright

## PACKING & LABEL SPECIFICATIONS

AA3020ARWC/Z

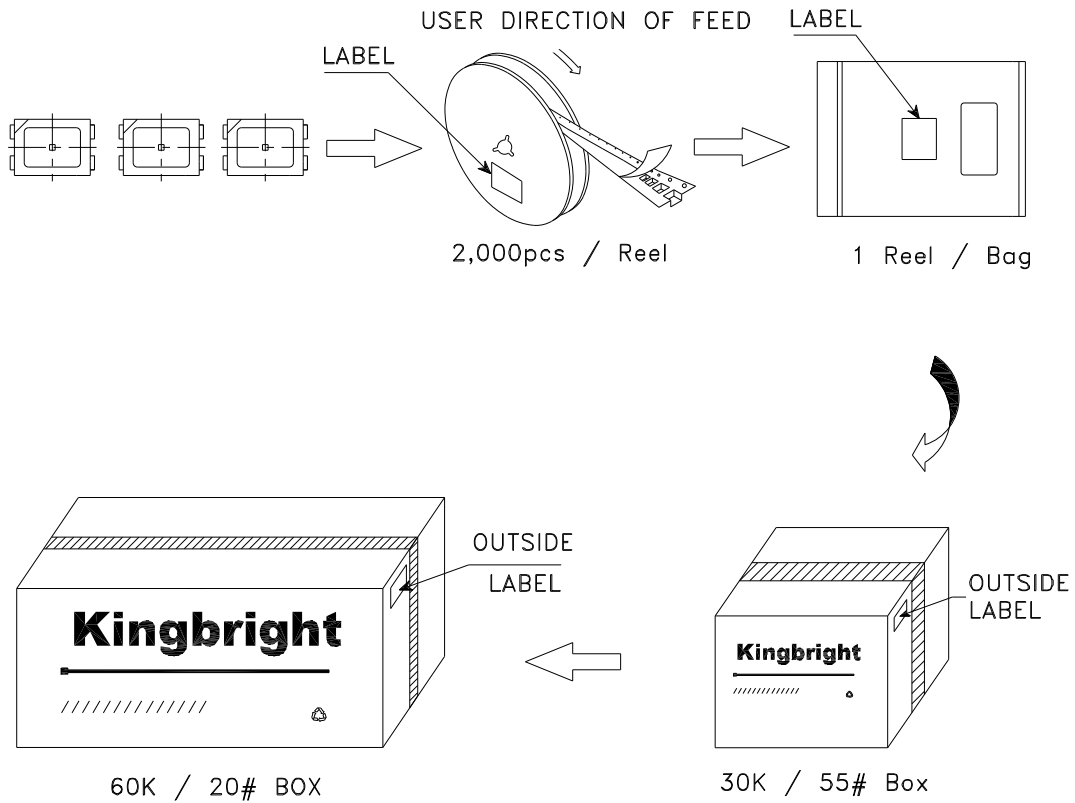

<b>Kingbright</b>	
P/NO: AA3020Axxx	
QTY: 2,000 pcs	Q.C. <span style="border: 1px solid black; border-radius: 50%; padding: 2px;">Q C XX XX XXXX PASSED</span>
S/N: XXXX	
CODE: XXX	
LOT NO:	
 xxxxxxxxxxxxxxxxxxxxxxxxxxxx	
RoHS Compliant	