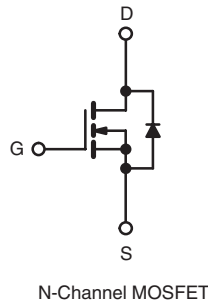
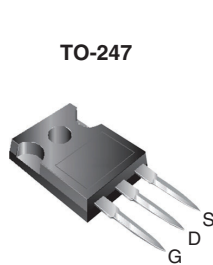


## Power MOSFET

PRODUCT SUMMARY		
$V_{DS}$ (V)	600	
$R_{DS(on)}$ ( $\Omega$ )	$V_{GS} = 10$ V	0.58
$Q_g$ (Max.) (nC)	70	
$Q_{gs}$ (nC)	19	
$Q_{gd}$ (nC)	28	
Configuration	Single	



### FEATURES

- Low Gate Charge  $Q_g$  Results in Simple Drive Requirement
- Improved Gate, Avalanche and Dynamic  $dV/dt$  Ruggedness
- Fully Characterized Capacitance and Avalanche Voltage and Current
- Effective  $C_{OSS}$  Specified
- Lead (Pb)-free Available


**RoHS\***  
COMPLIANT

### APPLICATIONS

- Switch Mode Power Supply (SMPS)
- Uninterruptable Power Supply
- High Speed Power Switching

### TYPICAL SMPS TOPOLOGY

- PFC Boost

ORDERING INFORMATION	
Package	TO-247
Lead (Pb)-free	IRFPC50APbF SiHFPC50A-E3
SnPb	IRFPC50A SiHFPC50A


ABSOLUTE MAXIMUM RATINGS $T_C = 25^\circ\text{C}$ , unless otherwise noted				
PARAMETER	SYMBOL	LIMIT	UNIT	
Drain-Source Voltage	$V_{DS}$	600	V	
Gate-Source Voltage	$V_{GS}$	$\pm 30$		
Continuous Drain Current	$V_{GS}$ at 10 V	$T_C = 25^\circ\text{C}$	A	
		$T_C = 100^\circ\text{C}$		
Pulsed Drain Current <sup>a</sup>	$I_{DM}$	44		
Linear Derating Factor		1.4	W/ $^\circ\text{C}$	
Single Pulse Avalanche Energy <sup>b</sup>	$E_{AS}$	920	mJ	
Repetitive Avalanche Current <sup>a</sup>	$I_{AR}$	11	A	
Repetitive Avalanche Energy <sup>a</sup>	$E_{AR}$	18	mJ	
Maximum Power Dissipation	$T_C = 25^\circ\text{C}$	$P_D$	180	W
Peak Diode Recovery $dV/dt^c$		$dV/dt$	4.9	V/ns
Operating Junction and Storage Temperature Range	$T_J, T_{stg}$	- 55 to + 150	$^\circ\text{C}$	
Soldering Recommendations (Peak Temperature)	for 10 s			300 <sup>d</sup>
Mounting Torque	6-32 or M3 screw		10	lbf · in
			1.1	N · m

#### Notes

- Repetitive rating; pulse width limited by maximum junction temperature (see fig. 11).
- Starting  $T_J = 25^\circ\text{C}$ ,  $L = 15$  mH,  $R_G = 25 \Omega$ ,  $I_{AS} = 11$  A (see fig. 12).
- $I_{SD} \leq 11$  A,  $dI/dt \leq 126$  A/ $\mu\text{s}$ ,  $V_{DD} \leq V_{DS}$ ,  $T_J \leq 150^\circ\text{C}$ .
- 1.6 mm from case.

\* Pb containing terminations are not RoHS compliant, exemptions may apply

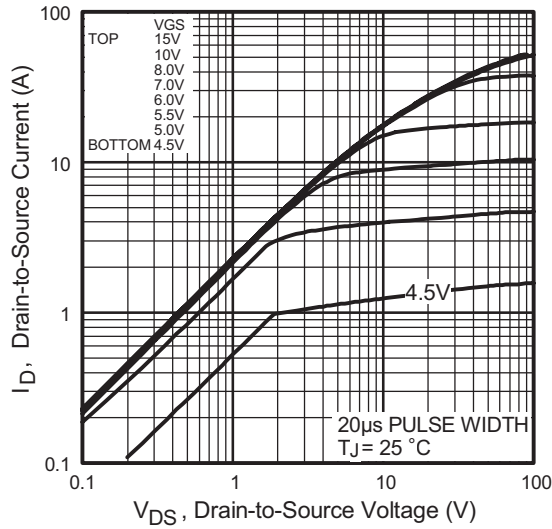
THERMAL RESISTANCE RATINGS				
PARAMETER	SYMBOL	TYP.	MAX.	UNIT
Maximum Junction-to-Ambient	$R_{thJA}$	-	40	°C/W
Case-to-Sink, Flat, Greased Surface	$R_{thCS}$	0.24	-	
Maximum Junction-to-Case (Drain)	$R_{thJC}$	-	0.65	

SPECIFICATIONS $T_J = 25\text{ }^\circ\text{C}$ , unless otherwise noted						
PARAMETER	SYMBOL	TEST CONDITIONS	MIN.	TYP.	MAX.	UNIT
<b>Static</b>						
Drain-Source Breakdown Voltage	$V_{DS}$	$V_{GS} = 0\text{ V}, I_D = 250\text{ }\mu\text{A}$	600	-	-	V
$V_{DS}$ Temperature Coefficient	$\Delta V_{DS}/T_J$	Reference to $25\text{ }^\circ\text{C}$ , $I_D = 1\text{ mA}$	-	0.65	-	V/°C
Gate-Source Threshold Voltage	$V_{GS(th)}$	$V_{DS} = V_{GS}, I_D = 250\text{ }\mu\text{A}$	2.0	-	4.0	V
Gate-Source Leakage	$I_{GSS}$	$V_{GS} = \pm 30\text{ V}$	-	-	$\pm 100$	nA
Zero Gate Voltage Drain Current	$I_{DSS}$	$V_{DS} = 600\text{ V}, V_{GS} = 0\text{ V}$	-	-	25	$\mu\text{A}$
		$V_{DS} = 480\text{ V}, V_{GS} = 0\text{ V}, T_J = 125\text{ }^\circ\text{C}$	-	-	250	
Drain-Source On-State Resistance	$R_{DS(on)}$	$V_{GS} = 10\text{ V}, I_D = 6.0\text{ A}^b$	-	-	0.58	$\Omega$
Forward Transconductance	$g_{fs}$	$V_{DS} = 50\text{ V}, I_D = 6.0\text{ A}^b$	7.7	-	-	S
<b>Dynamic</b>						
Input Capacitance	$C_{iss}$	$V_{GS} = 0\text{ V}, V_{DS} = 25\text{ V}, f = 1.0\text{ MHz}$ , see fig. 5	-	2100	-	pF
Output Capacitance	$C_{oss}$		-	270	-	
Reverse Transfer Capacitance	$C_{rss}$		-	9.7	-	
Output Capacitance	$C_{oss}$	$V_{GS} = 0\text{ V}$	$V_{DS} = 1.0\text{ V}, f = 1.0\text{ MHz}$	-	2830	-
			$V_{DS} = 480\text{ V}, f = 1.0\text{ MHz}$	-	74	-
Effective Output Capacitance	$C_{oss\text{ eff.}}$	$V_{DS} = 0\text{ V to } 480\text{ V}^c$	-	81	-	
Total Gate Charge	$Q_g$	$V_{GS} = 10\text{ V}, I_D = 11\text{ A}, V_{DS} = 480\text{ V}$ see fig. 6 and 13 <sup>b</sup>	-	-	70	nC
Gate-Source Charge	$Q_{gs}$		-	-	19	
Gate-Drain Charge	$Q_{gd}$		-	-	28	
Turn-On Delay Time	$t_{d(on)}$	$V_{DD} = 300\text{ V}, I_D = 11\text{ A}, R_G = 6.2\text{ }\Omega, R_D = 30\text{ }\Omega$ see fig. 10 <sup>b</sup>	-	15	-	ns
Rise Time	$t_r$		-	40	-	
Turn-Off Delay Time	$t_{d(off)}$		-	33	-	
Fall Time	$t_f$		-	29	-	
<b>Drain-Source Body Diode Characteristics</b>						
Continuous Source-Drain Diode Current	$I_S$	MOSFET symbol showing the integral reverse p - n junction diode 	-	-	11	A
Pulsed Diode Forward Current <sup>a</sup>	$I_{SM}$		-	-	44	
Body Diode Voltage	$V_{SD}$	$T_J = 25\text{ }^\circ\text{C}, I_S = 11\text{ A}, V_{GS} = 0\text{ V}^b$	-	-	1.4	V
Body Diode Reverse Recovery Time	$t_{rr}$	$T_J = 25\text{ }^\circ\text{C}, I_F = 11\text{ A}, di/dt = 100\text{ A}/\mu\text{s}^b$	-	500	740	ns
Body Diode Reverse Recovery Charge	$Q_{rr}$		-	4.0	6.0	$\mu\text{C}$
Forward Turn-On Time	$t_{on}$	Intrinsic turn-on time is negligible (turn-on is dominated by $L_S$ and $L_D$ )				

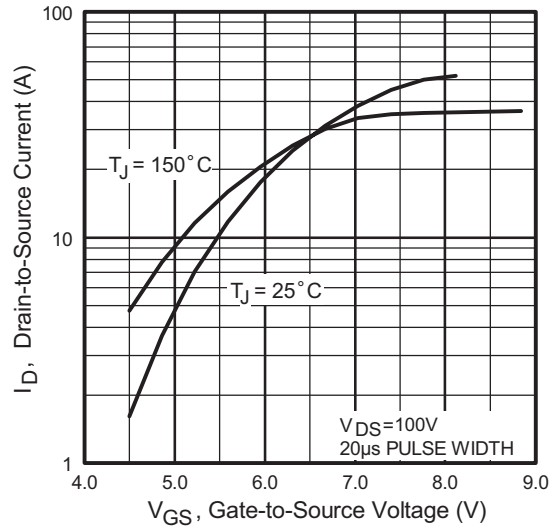
**Notes**

- a. Repetitive rating; pulse width limited by maximum junction temperature (see fig. 11).
- b. Pulse width  $\leq 300\text{ }\mu\text{s}$ ; duty cycle  $\leq 2\%$ .
- c.  $C_{oss\text{ eff.}}$  is a fixed capacitance that gives the same charging time as  $C_{oss}$  while  $V_{DS}$  is rising from 0 to 80 %  $V_{DS}$ .

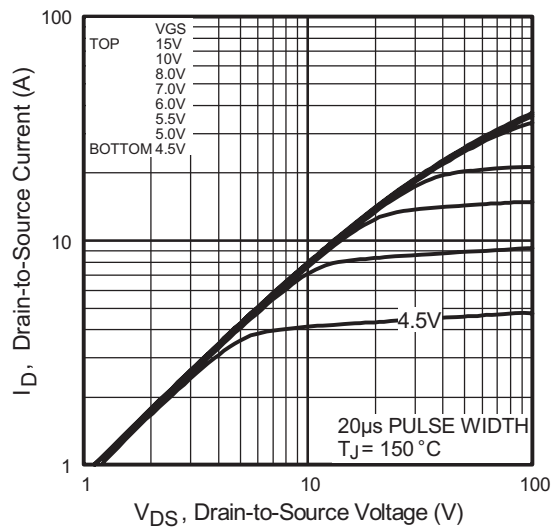
**TYPICAL CHARACTERISTICS** 25 °C, unless otherwise noted



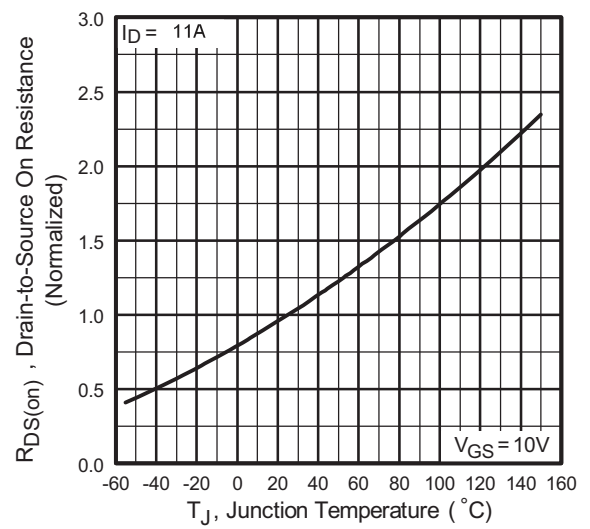
**Fig. 1 - Typical Output Characteristics**



**Fig. 3 - Typical Transfer Characteristics**



**Fig. 2 - Typical Output Characteristics**



**Fig. 4 - Normalized On-Resistance vs. Temperature**

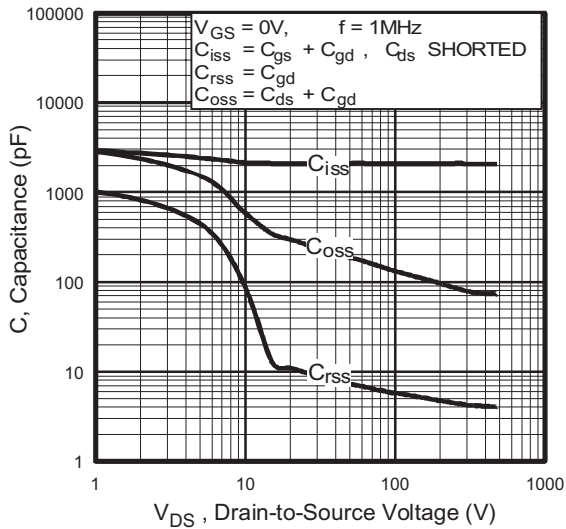


Fig. 5 - Typical Capacitance vs. Drain-to-Source Voltage

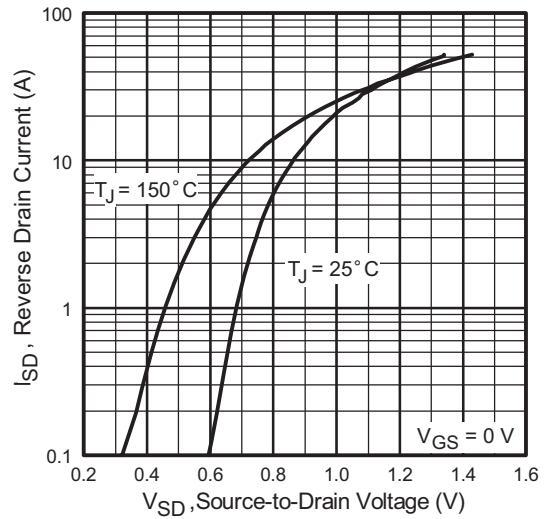


Fig. 7 - Typical Source-Drain Diode Forward Voltage

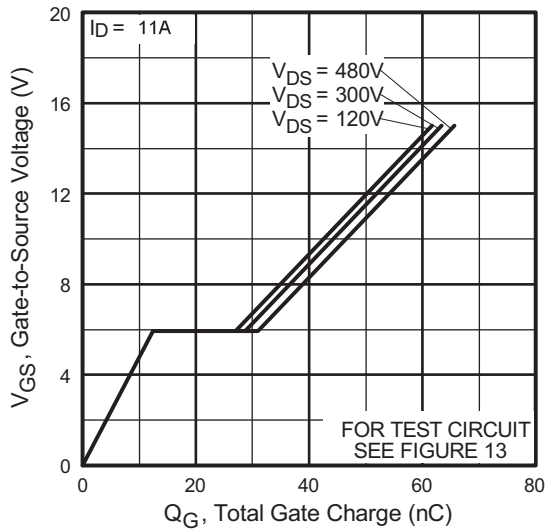


Fig. 6 - Typical Gate Charge vs. Gate-to-Source Voltage

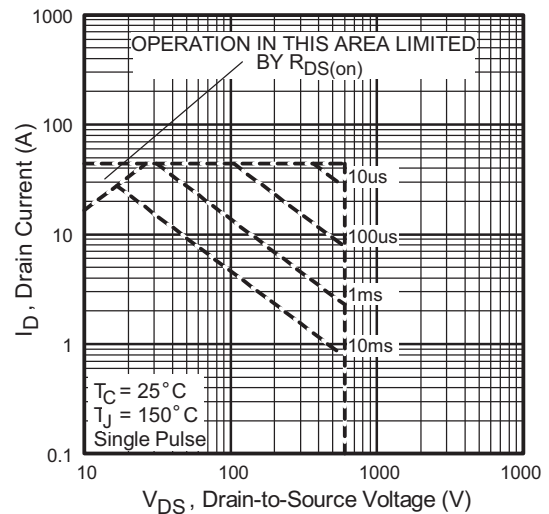
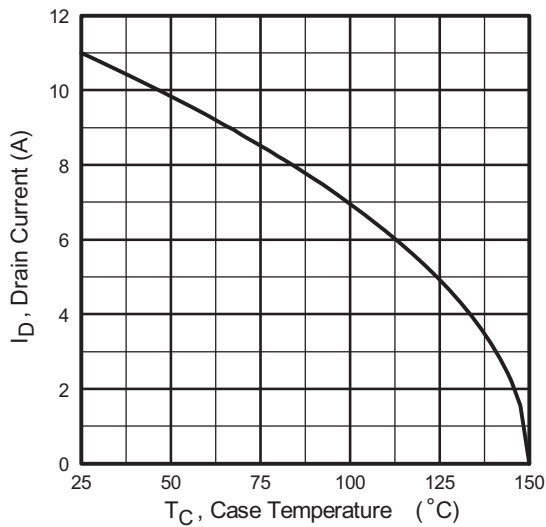
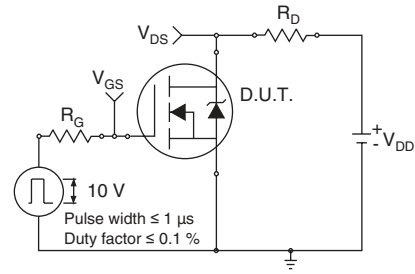


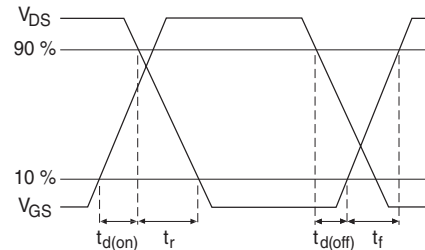
Fig. 8 - Maximum Safe Operating Area



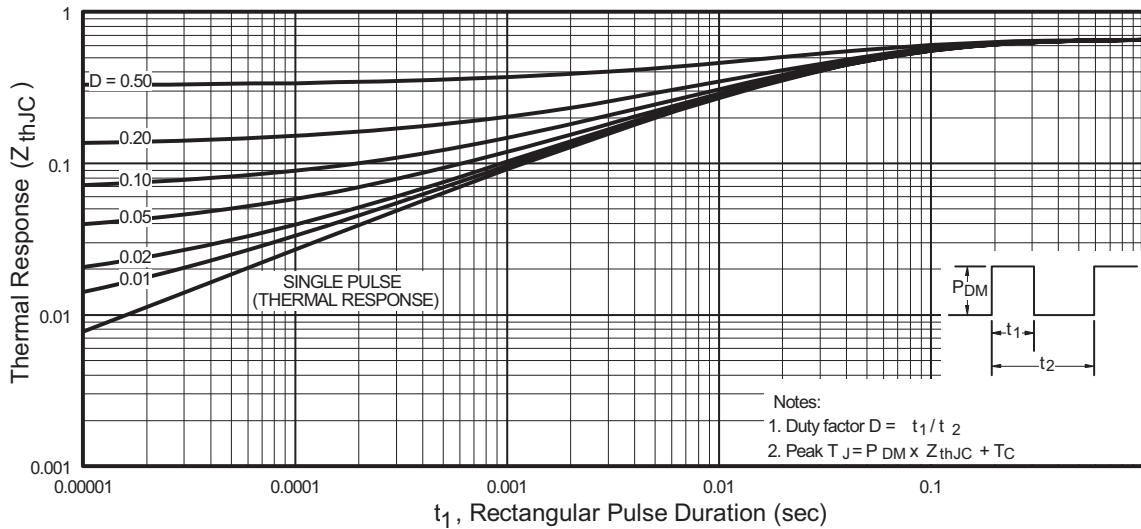
**Fig. 9 - Maximum Drain Current vs. Case Temperature**



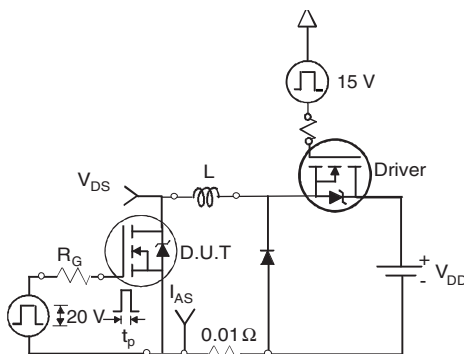
**Fig. 10a - Switching Time Test Circuit**



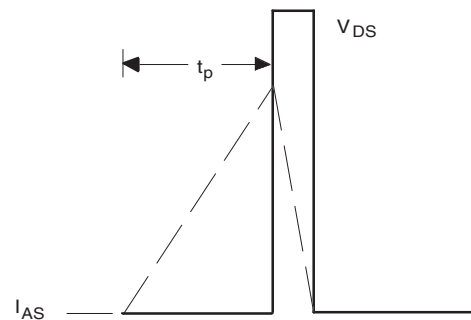
**Fig. 10b - Switching Time Waveforms**



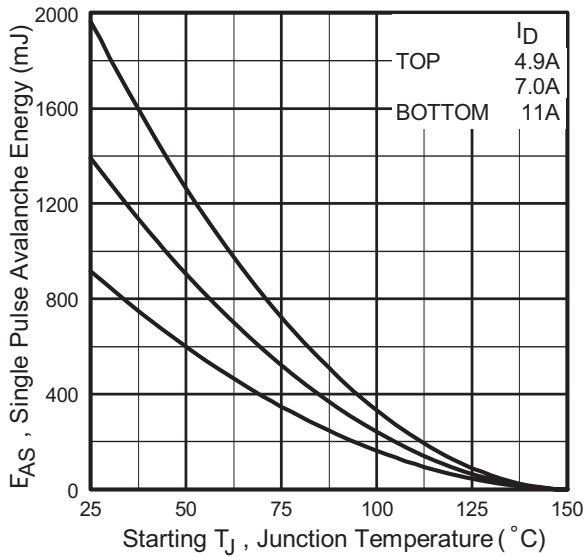
**Fig. 11 - Maximum Effective Transient Thermal Impedance, Junction-to-Case**



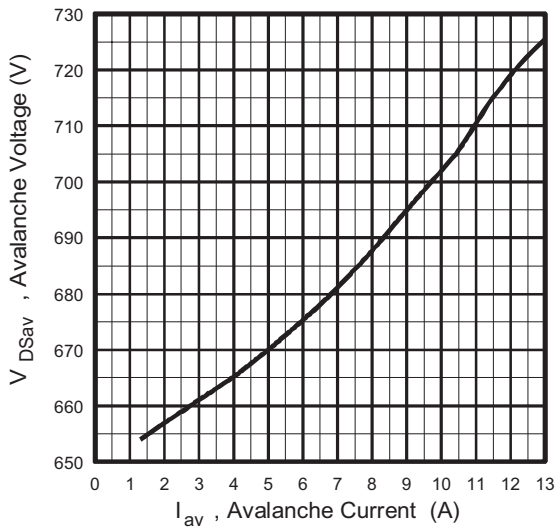
**Fig. 12a - Unclamped Inductive Test Circuit**



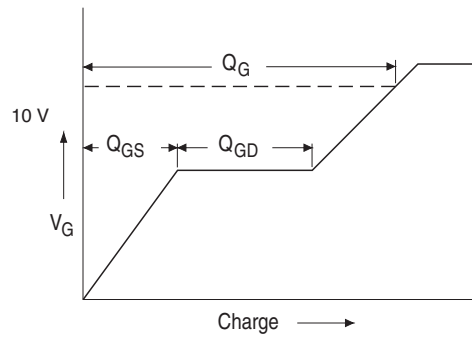
**Fig. 12b - Unclamped Inductive Waveforms**



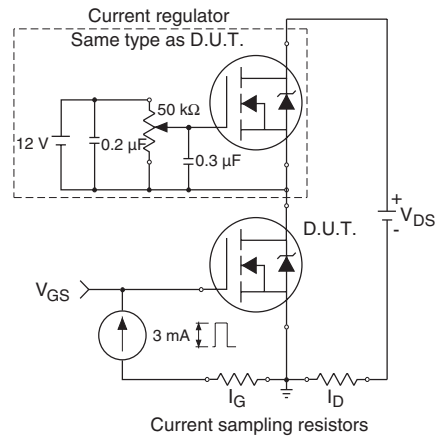
**Fig. 12c - Maximum Avalanche Energy vs. Drain Current**



**Fig. 12d - Typical Drain-to-Source Voltage vs. Avalanche Current**

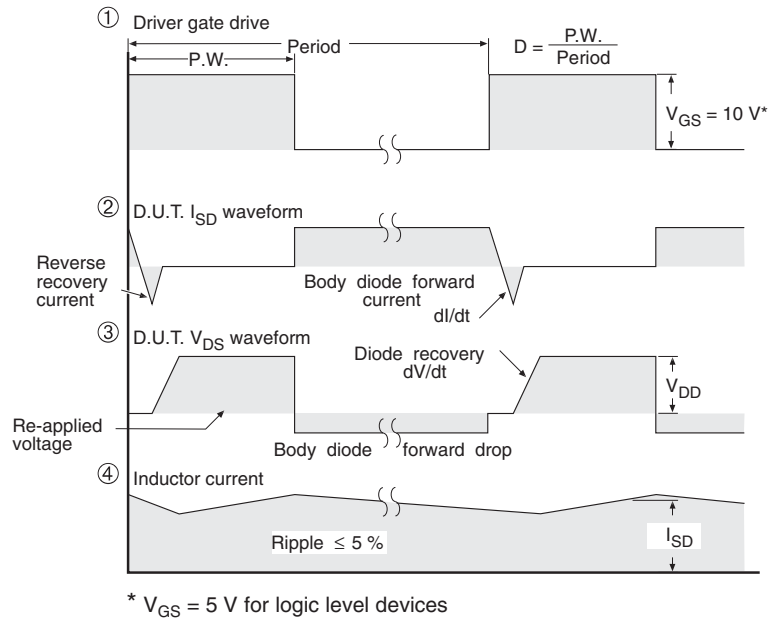
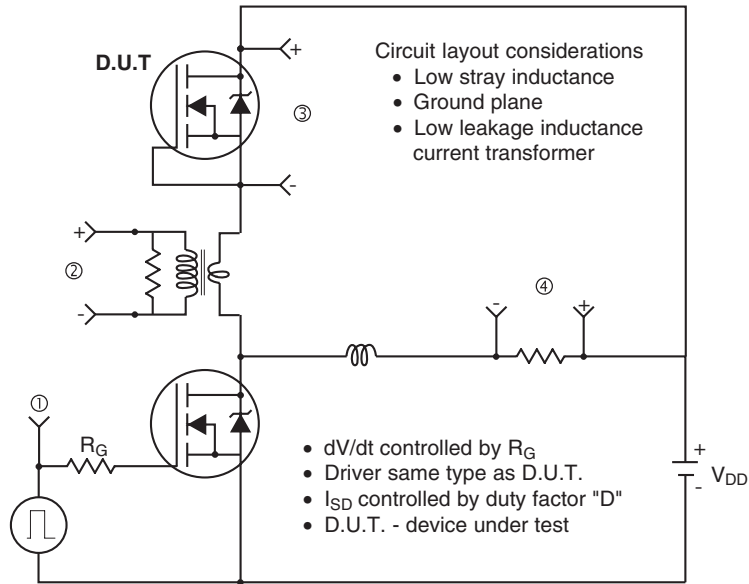


**Fig. 13a - Basic Gate Charge Waveform**



**Fig. 13b - Gate Charge Test Circuit**

## Peak Diode Recovery $dV/dt$ Test Circuit



**Fig. 14 - For N-Channel**

Vishay Siliconix maintains worldwide manufacturing capability. Products may be manufactured at one of several qualified locations. Reliability data for Silicon Technology and Package Reliability represent a composite of all qualified locations. For related documents such as package/tape drawings, part marking, and reliability data, see <http://www.vishay.com/ppg?91241>.



## Disclaimer

All product specifications and data are subject to change without notice.

Vishay Intertechnology, Inc., its affiliates, agents, and employees, and all persons acting on its or their behalf (collectively, "Vishay"), disclaim any and all liability for any errors, inaccuracies or incompleteness contained herein or in any other disclosure relating to any product.

Vishay disclaims any and all liability arising out of the use or application of any product described herein or of any information provided herein to the maximum extent permitted by law. The product specifications do not expand or otherwise modify Vishay's terms and conditions of purchase, including but not limited to the warranty expressed therein, which apply to these products.

No license, express or implied, by estoppel or otherwise, to any intellectual property rights is granted by this document or by any conduct of Vishay.

The products shown herein are not designed for use in medical, life-saving, or life-sustaining applications unless otherwise expressly indicated. Customers using or selling Vishay products not expressly indicated for use in such applications do so entirely at their own risk and agree to fully indemnify Vishay for any damages arising or resulting from such use or sale. Please contact authorized Vishay personnel to obtain written terms and conditions regarding products designed for such applications.

Product names and markings noted herein may be trademarks of their respective owners.