

Standard Diodes, 100 A (ADD-A-PAK Generation 5 Power Modules)



ADD-A-PAK

PRODUCT SUMMARY

$I_{F(AV)}$	100 A
-------------	-------

MECHANICAL DESCRIPTION

The Generation 5 of ADD-A-PAK module combine the excellent thermal performance obtained by the usage of direct bonded copper substrate with superior mechanical ruggedness, thanks to the insertion of a solid copper baseplate at the bottom side of the device. The Cu baseplate allow an easier mounting on the majority of heatsink with increased tolerance of surface roughness and improve thermal spread.

The Generation 5 of AAP module is manufactured without hard mold, eliminating in this way any possible direct stress on the leads.

The electrical terminals are secured against axial pull-out: they are fixed to the module housing via a click-stop feature already tested and proved as reliable on other Vishay HPP modules.

FEATURES

- High voltage
- Industrial standard package
- Thick copper baseplate
- UL E78996 approved 
- 3500 V_{RMS} isolating voltage
- Totally lead (Pb)-free
- Designed and qualified for industrial level



RoHS
COMPLIANT

BENEFITS

- Up to 1600 V
- Fully compatible TO-240AA
- High surge capability
- Easy mounting on heatsink
- Al₂O₃ DBC insulator
- Heatsink grounded

ELECTRICAL DESCRIPTION

These modules are intended for general purpose high voltage applications such as high voltage regulated power supplies, lighting circuits, temperature and motor speed control circuits, UPS and battery charger.

MAJOR RATINGS AND CHARACTERISTICS

SYMBOL	CHARACTERISTICS	VALUES	UNITS
$I_{F(AV)}$		100	A
	T_C	100	°C
$I_{F(RMS)}$		157	A
I_{FSM}	50 Hz	2020	
	60 Hz	2110	
I^2t	50 Hz	20.43	
	60 Hz	18.65	
$I^2\sqrt{t}$		204.3	kA ² √s
V_{RRM}	Range	400 to 1600	V
T_J		- 40 to 150	°C
T_{Stg}			

ELECTRICAL SPECIFICATIONS

VOLTAGE RATINGS				
TYPE NUMBER	VOLTAGE CODE	V _{RRM} , MAXIMUM REPETITIVE PEAK REVERSE VOLTAGE V	V _{RSM} , MAXIMUM NON-REPETITIVE PEAK REVERSE VOLTAGE V	I _{RRM} MAXIMUM AT T _J = 150 °C mA
VSK.91	04	400	500	10
	06	600	700	
	08	800	900	
	10	1000	1100	
	12	1200	1300	
	14	1400	1500	
	16	1600	1700	

FORWARD CONDUCTION					
PARAMETER	SYMBOL	TEST CONDITIONS		VALUES	UNITS
Maximum average forward current at case temperature	I _{F(AV)}	180° conduction, half sine wave		100	A
				100	°C
Maximum RMS forward current	I _{F(RMS)}	DC at 90 °C case temperature		157	A
Maximum peak, one-cycle forward, non-repetitive surge current	I _{FSM}	t = 10 ms	No voltage reappplied	2020	
		t = 8.3 ms		2110	
		t = 10 ms	100 % V _{RRM} reappplied	1700	
		t = 8.3 ms		1780	
Maximum I ² t for fusing	I ² t	t = 10 ms	No voltage reappplied	20.43	kA ² s
		t = 8.3 ms		18.65	
		t = 10 ms	100 % V _{RRM} reappplied	14.45	
		t = 8.3 ms		13.19	
Maximum I ² √t for fusing	I ² √t	t = 0.1 to 10 ms, no voltage reappplied		204.3	kA ² √s
Low level value of threshold voltage	V _{F(TO)1}	(16.7 % × π × I _{F(AV)} < I < π × I _{F(AV)}), T _J = T _J maximum		0.79	V
High level value of threshold voltage	V _{F(TO)2}	(I > π × I _{F(AV)}), T _J = T _J maximum		0.87	
Low level value of forward slope resistance	r _{f1}	(16.7 % × π × I _{F(AV)} < I < π × I _{F(AV)}), T _J = T _J maximum		1.78	mΩ
High level value of forward slope resistance	r _{f2}	(I > π × I _{F(AV)}), T _J = T _J maximum		1.57	
Maximum forward voltage drop	V _{FM}	I _{FM} = π × I _{F(AV)} , T _J = 25 °C, t _p = 400 μs square wave		1.45	V

BLOCKING					
PARAMETER	SYMBOL	TEST CONDITIONS		VALUES	UNITS
Maximum peak reverse leakage current	I _{RRM}	T _J = 150 °C		10	mA
RMS insulation voltage	V _{INS}	50 Hz, circuit to base, all terminals shorted		3500 (1 s)	V



THERMAL AND MECHANICAL SPECIFICATIONS				
PARAMETER	SYMBOL	TEST CONDITIONS	VALUES	UNITS
Maximum junction operating and storage temperature range	T_J, T_{Stg}		- 40 to 150	°C
Maximum thermal resistance, junction to case per junction	R_{thJC}	DC operation	0.35	K/W
Typical thermal resistance, case to heatsink	R_{thCS}	Mounting surface flat, smooth and greased	0.1	
Mounting torque $\pm 10\%$ to heatsink busbar		A mounting compound is recommended and the torque should be rechecked after a period of 3 hours to allow for the spread of the compound	5	Nm
			4	
Approximate weight			110	g
			4	oz.
Case style		JEDEC	TO-240AA	

ΔR CONDUCTION PER JUNCTION											
DEVICES	SINE HALF WAVE CONDUCTION					RECTANGULAR WAVE CONDUCTION					UNITS
	180°	120°	90°	60°	30°	180°	120°	90°	60°	30°	
VSK.91	0.052	0.064	0.082	0.112	0.164	0.043	0.069	0.088	0.115	0.165	°C/W

Note

- Table shows the increment of thermal resistance R_{thJC} when devices operate at different conduction angles than DC

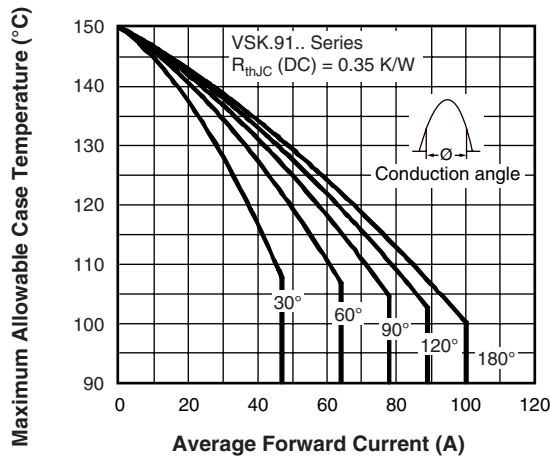

Fig. 1 - Current Ratings Characteristics

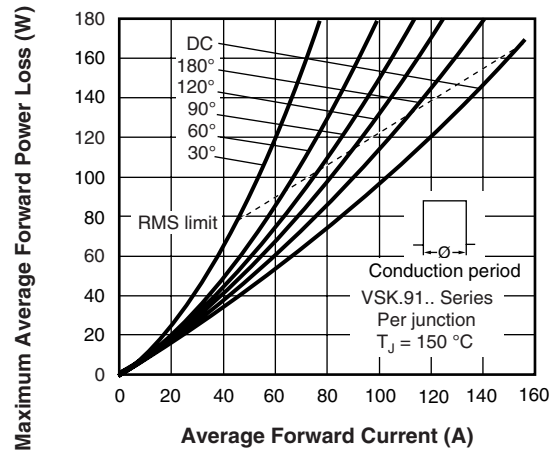

Fig. 4 - Forward Power Loss Characteristics

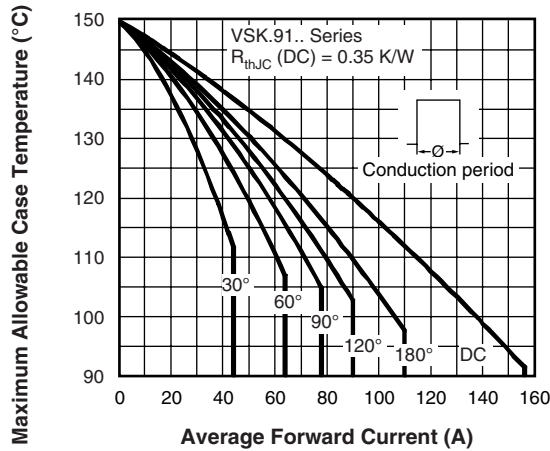

Fig. 2 - Current Ratings Characteristics

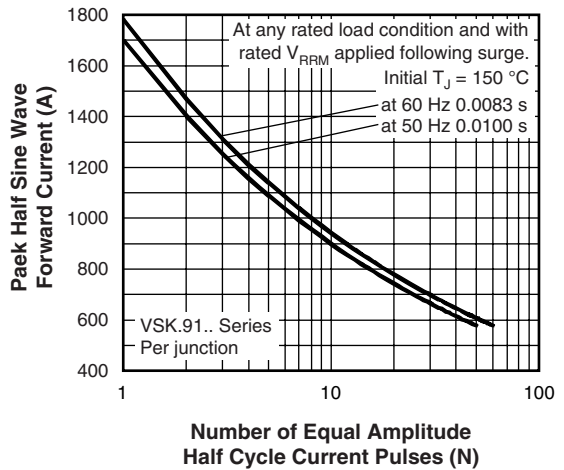

Fig. 5 - Maximum Non-Repetitive Surge Current

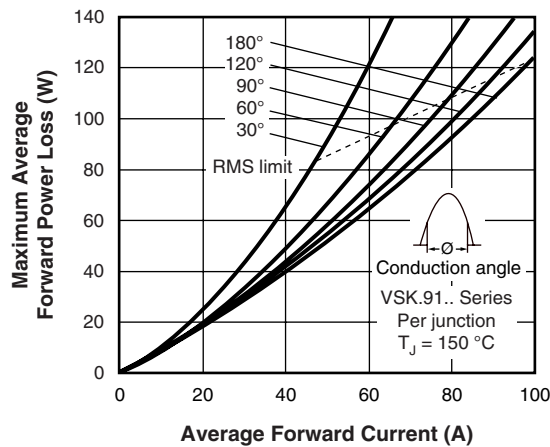

Fig. 3 - Forward Power Loss Characteristics

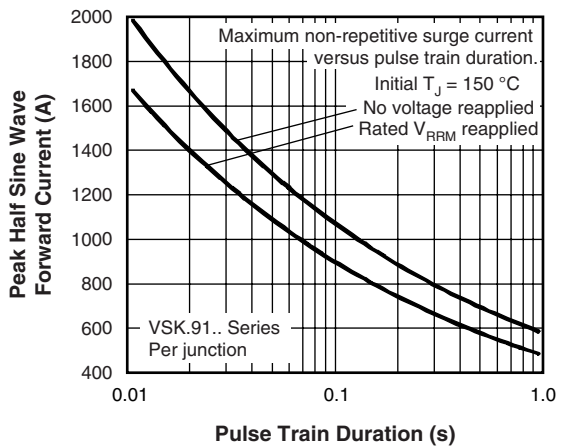

Fig. 6 - Maximum Non-Repetitive Surge Current



Standard Diodes, 100 A
(ADD-A-PAK Generation 5 Power Modules)

VSK.91..PbF Series

Vishay High Power Products

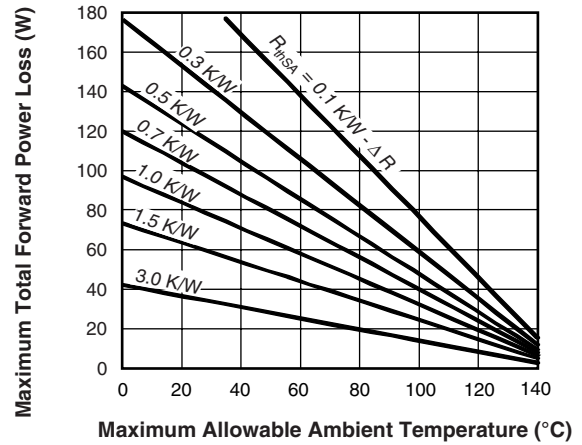
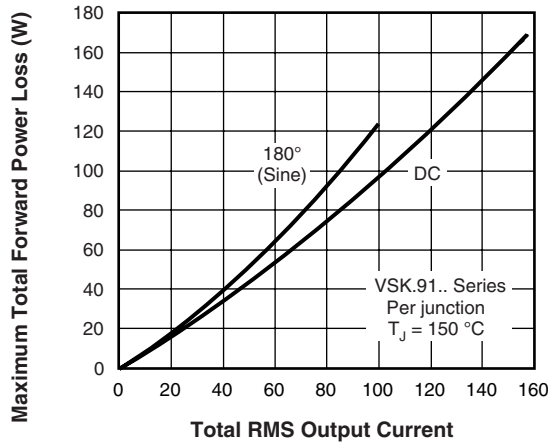

Fig. 7 - Forward Power Loss Characteristics

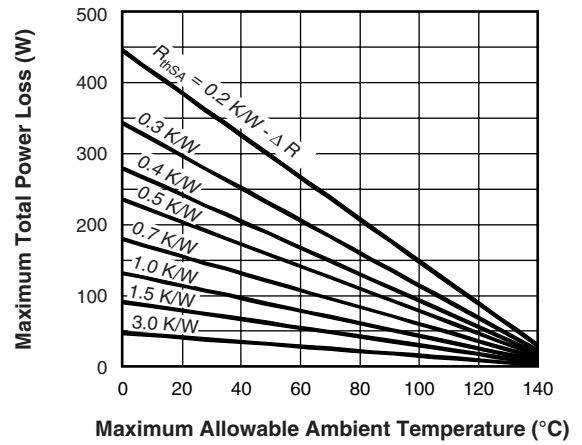
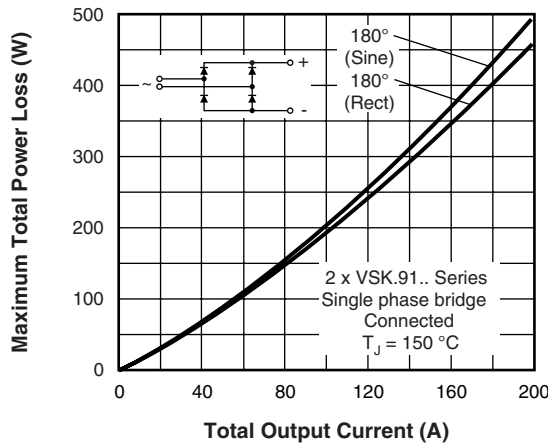

Fig. 8 - Forward Power Loss Characteristics

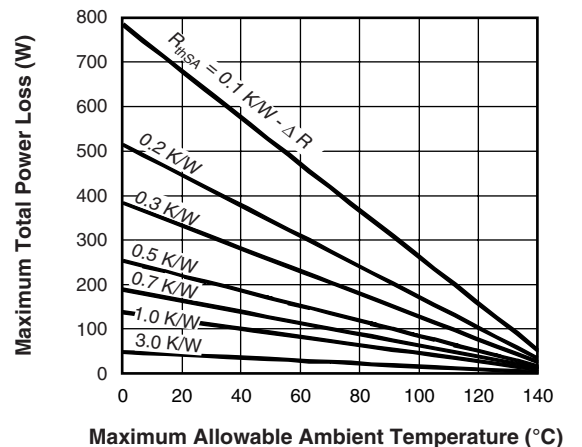
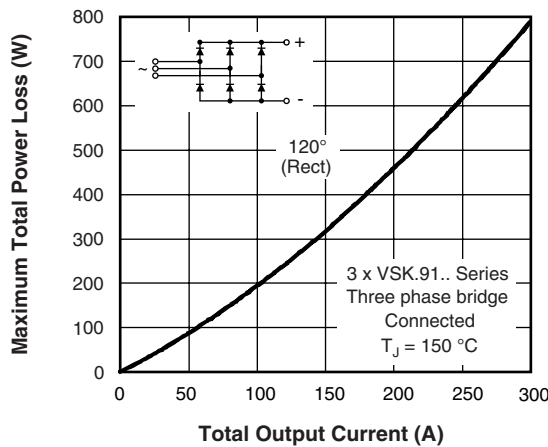

Fig. 9 - Forward Power Loss Characteristics

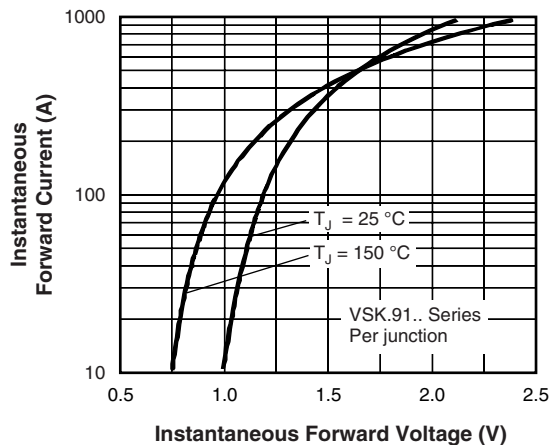

Fig. 10 - Forward Voltage Drop Characteristics

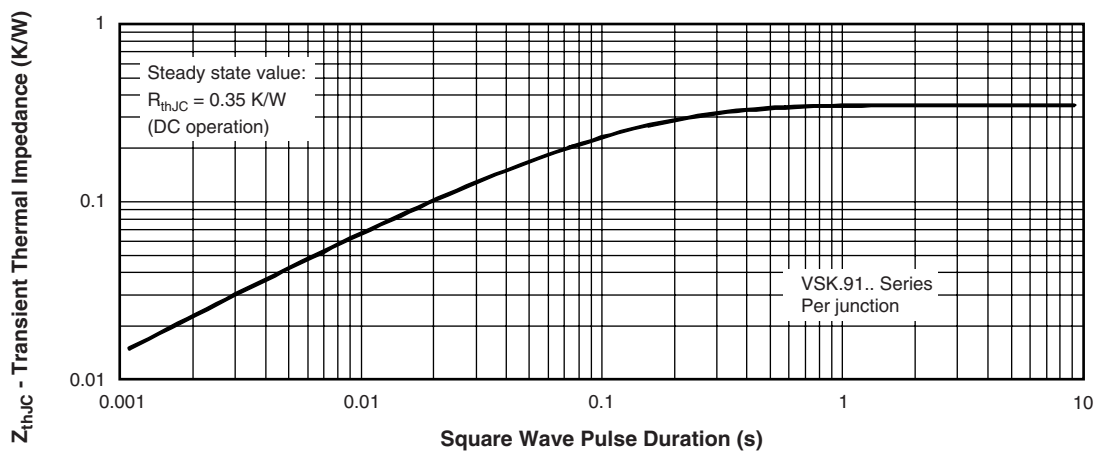
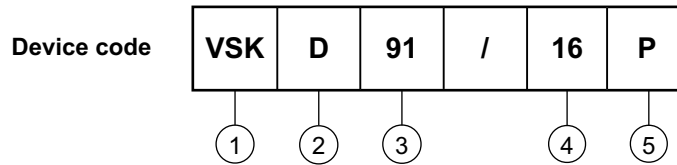

Fig. 11 - Thermal Impedance Z_{thJC} Characteristic



ORDERING INFORMATION TABLE



- 1** - Module type
- 2** - Circuit configuration (see end of datasheet)
- 3** - Current code
- 4** - Voltage code (see Voltage Ratings table)
- 5** - P = Lead (Pb)-free

Note

- To order the optional hardware go to www.vishay.com/doc?95172

CIRCUIT CONFIGURATION

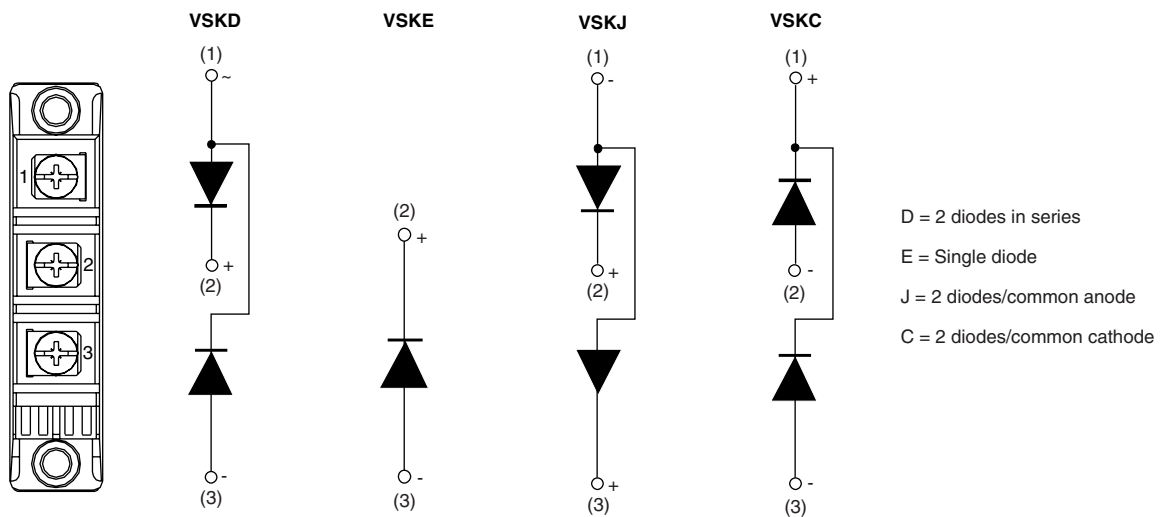

LINKS TO RELATED DOCUMENTS

Dimensions	http://www.vishay.com/doc?95015
------------	---



Disclaimer

All product specifications and data are subject to change without notice.

Vishay Intertechnology, Inc., its affiliates, agents, and employees, and all persons acting on its or their behalf (collectively, "Vishay"), disclaim any and all liability for any errors, inaccuracies or incompleteness contained herein or in any other disclosure relating to any product.

Vishay disclaims any and all liability arising out of the use or application of any product described herein or of any information provided herein to the maximum extent permitted by law. The product specifications do not expand or otherwise modify Vishay's terms and conditions of purchase, including but not limited to the warranty expressed therein, which apply to these products.

No license, express or implied, by estoppel or otherwise, to any intellectual property rights is granted by this document or by any conduct of Vishay.

The products shown herein are not designed for use in medical, life-saving, or life-sustaining applications unless otherwise expressly indicated. Customers using or selling Vishay products not expressly indicated for use in such applications do so entirely at their own risk and agree to fully indemnify Vishay for any damages arising or resulting from such use or sale. Please contact authorized Vishay personnel to obtain written terms and conditions regarding products designed for such applications.

Product names and markings noted herein may be trademarks of their respective owners.