



## N-Channel 20-V (D-S) MOSFET With Schottky Diode

<b>MOSFET PRODUCT SUMMARY</b>		
$V_{DS}$ (V)	$r_{DS(on)}$ ( $\Omega$ )	$I_D$ (A)
20	0.125 @ $V_{GS} = 4.5$ V	2.4
	0.200 @ $V_{GS} = 2.5$ V	1.8

<b>SCHOTTKY PRODUCT SUMMARY</b>		
$V_{KA}$ (V)	$V_f$ (V) Diode Forward Voltage	$I_F$ (A)
20	0.48 V @ 0.5 A	0.5

**FEATURES**

- LITTLE FOOT *Plus*™
- 100%  $R_g$  Tested

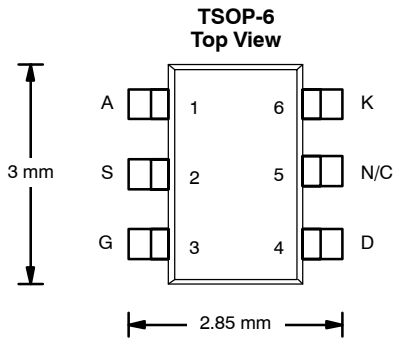

Ordering Information: Si3812DV-T1

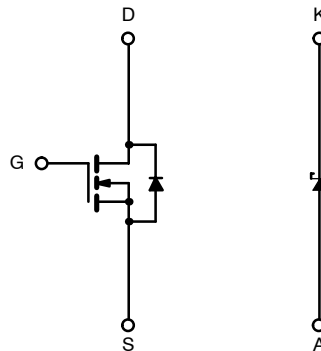

<b>ABSOLUTE MAXIMUM RATINGS (<math>T_A = 25^\circ\text{C}</math> UNLESS OTHERWISE NOTED)</b>					
Parameter	Symbol	5 sec	Steady State	Unit	
Drain-Source Voltage (MOSFET)	$V_{DS}$	20		V	
Reverse Voltage (Schottky)	$V_{KA}$	20			
Gate-Source Voltage (MOSFET)	$V_{GS}$	$\pm 12$			
Continuous Drain Current ( $T_J = 150^\circ\text{C}$ ) (MOSFET) <sup>a</sup>	$T_A = 25^\circ\text{C}$	$I_D$	2.4	2.0	A
	$T_A = 85^\circ\text{C}$		1.7	1.4	
Pulsed Drain Current (MOSFET)		$I_{DM}$	8		
Continuous Source Current (MOSFET Diode Conduction) <sup>a</sup>		$I_S$	1.05	0.75	
Average Forward Current (Schottky)		$I_F$	0.5	0.5	
Pulsed Forward Current (Schottky)		$I_{FM}$	8	8	
Maximum Power Dissipation (MOSFET) <sup>a</sup>	$T_A = 25^\circ\text{C}$	$P_D$	1.15	0.83	W
	$T_A = 85^\circ\text{C}$		0.59	0.53	
Maximum Power Dissipation (Schottky) <sup>a</sup>	$T_A = 25^\circ\text{C}$		1.0	0.76	
	$T_A = 85^\circ\text{C}$		0.52	0.48	
Operating Junction and Storage Temperature Range	$T_J, T_{stg}$	-55 to 150		$^\circ\text{C}$	

**Notes**

a. Surface Mounted on 1" x 1" FR4 Board.

THERMAL RESISTANCE RATINGS						
Parameter		Device	Symbol	Typical	Maximum	Unit
Junction-to-Ambient <sup>a</sup>	$t \leq 5 \text{ sec}$	MOSFET	$R_{thJA}$	93	110	°C/W
		Schottky		103	125	
Junction-to-Ambient <sup>a</sup>	Steady State	MOSFET		130	150	
		Schottky		140	165	
Junction-to-Foot (MOSFET Drain, Schottky Kathode)	Steady State	MOSFET	$R_{thJF}$	75	90	
		Schottky		80	95	

## Notes

a. Surface Mounted on 1" x1" FR4 Board.

MOSFET + SCHOTTKY SPECIFICATIONS ( $T_J = 25^\circ\text{C}$ UNLESS OTHERWISE NOTED)						
Parameter	Symbol	Test Condition	Min	Typ	Max	Unit
<b>Static</b>						
Gate Threshold Voltage	$V_{GS(th)}$	$V_{DS} = V_{GS}, I_D = 250 \mu\text{A}$	0.6			V
Gate-Body Leakage	$I_{GSS}$	$V_{DS} = 0 \text{ V}, V_{GS} = \pm 12 \text{ V}$			$\pm 100$	nA
Zero Gate Voltage Drain Current (MOSFET + Schottky)	$I_{DSS}$	$V_{DS} = 16 \text{ V}, V_{GS} = 0 \text{ V}$			1	$\mu\text{A}$
		$V_{DS} = 16 \text{ V}, V_{GS} = 0 \text{ V}, T_J = 85^\circ\text{C}$			10	
On-State Drain Current <sup>a</sup>	$I_{D(on)}$	$V_{DS} \geq 5 \text{ V}, V_{GS} = 4.5 \text{ V}$	5			A
Drain-Source On-State Resistance <sup>a</sup>	$r_{DS(on)}$	$V_{GS} = 4.5 \text{ V}, I_D = 2.4 \text{ A}$		0.100	0.125	$\Omega$
		$V_{GS} = 2.5 \text{ V}, I_D = 1.0 \text{ A}$		0.160	0.200	
Forward Transconductance <sup>a</sup>	$g_{fs}$	$V_{DS} = 5 \text{ V}, I_D = 2.4 \text{ A}$		5		S
Schottky Diode Forward Voltage <sup>a</sup>	$V_{SD}$	$I_S = 1.5 \text{ A}, V_{GS} = 0 \text{ V}$		0.79	1.1	V
<b>Dynamic<sup>b</sup></b>						
Total Gate Charge	$Q_g$	$V_{DS} = 10 \text{ V}, V_{GS} = 4.5 \text{ V}, I_D = 2.4 \text{ A}$		2.1	4.0	nC
Gate-Source Charge	$Q_{gs}$		0.3			
Gate-Drain Charge	$Q_{gd}$		0.4			
Gate Resistance	$R_g$		1		3.7	$\Omega$
Turn-On Delay Time	$t_{d(on)}$	$V_{DD} = 10 \text{ V}, R_L = 10 \Omega$ $I_D \cong 1 \text{ A}, V_{GEN} = 4.5 \text{ V}, R_G = 6 \Omega$		10	17	ns
Rise Time	$t_r$		30	50		
Turn-Off Delay Time	$t_{d(off)}$		14	25		
Fall Time	$t_f$		6	12		
Source-Drain Reverse Recovery Time	$t_{rr}$	$I_F = 3.0 \text{ A}, di/dt = 100 \text{ A}/\mu\text{s}$		30	50	

## Notes

a. Pulse test; pulse width  $\leq 300 \mu\text{s}$ , duty cycle  $\leq 2\%$ .

b. Guaranteed by design, not subject to production testing.

SCHOTTKY SPECIFICATIONS ( $T_J = 25^\circ\text{C}$ UNLESS OTHERWISE NOTED)						
Parameter	Symbol	Test Condition	Min	Typ	Max	Unit
Forward Voltage Drop	$V_F$	$I_F = 0.5$		0.42	0.48	V
		$I_F = 0.5, T_J = 125^\circ\text{C}$		0.33	0.4	
Maximum Reverse Leakage Current	$I_{rm}$	$V_r = 20$		0.002	0.100	mA
		$V_r = 20, T_J = 75^\circ\text{C}$		0.06	1	
		$V_r = 20, T_J = 125^\circ\text{C}$		1.5	10	
Junction Capacitance	$C_T$	$V_r = 10 \text{ V}$		31		pF



**TYPICAL CHARACTERISTICS (25°C UNLESS NOTED) MOSFET**

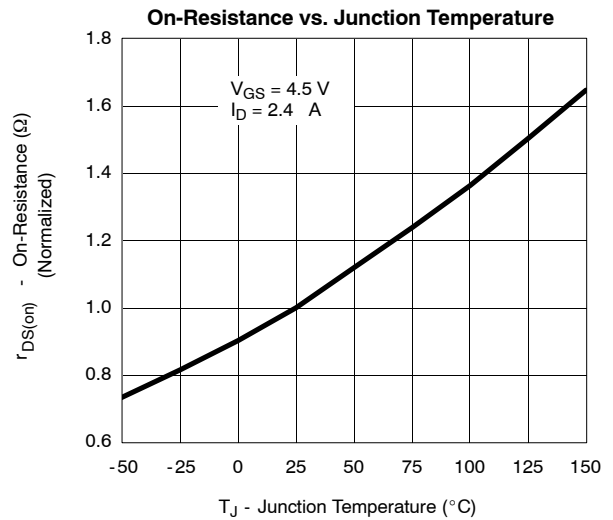
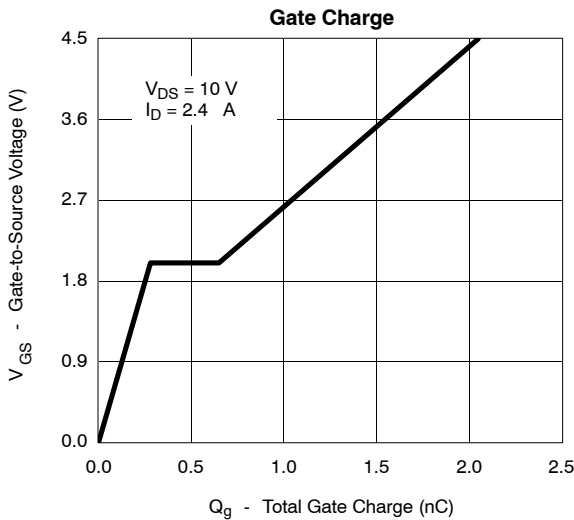
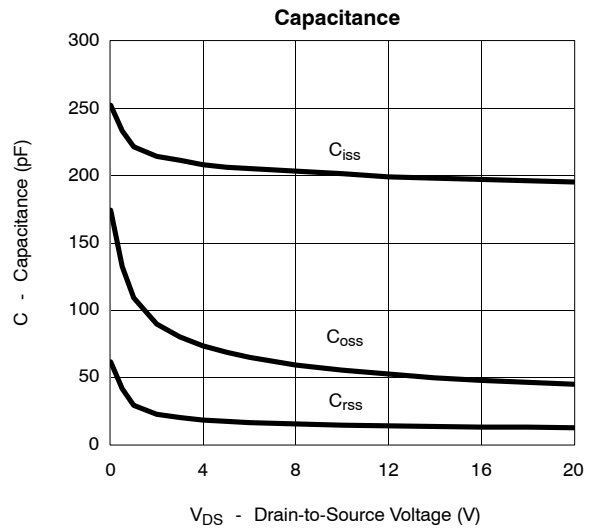
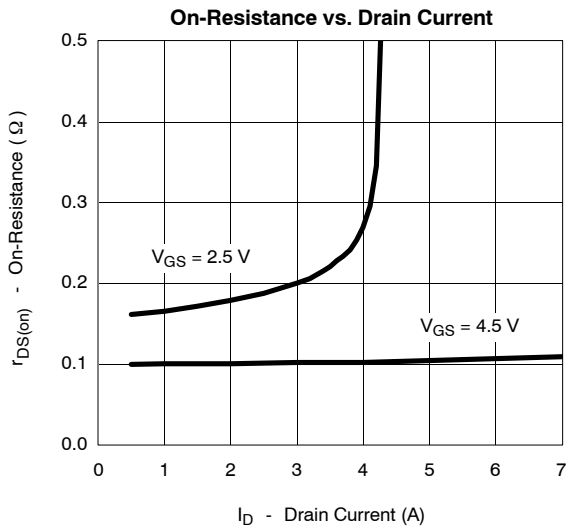
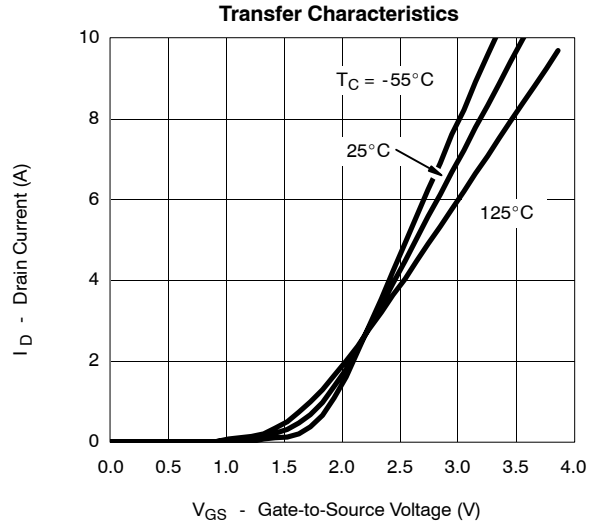
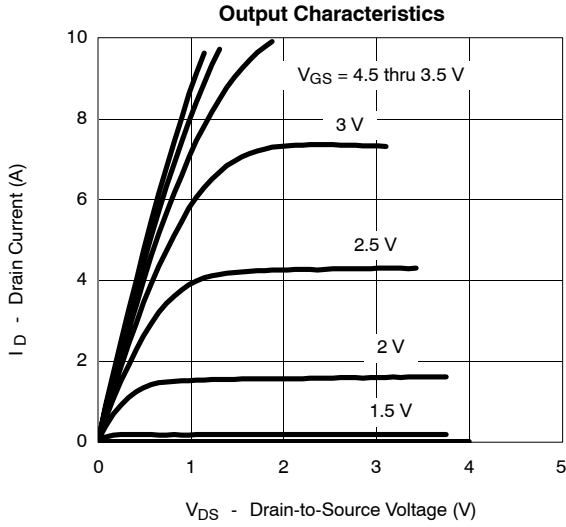



**TYPICAL CHARACTERISTICS (25°C UNLESS NOTED)**

**MOSFET**

**Source-Drain Diode Forward Voltage**

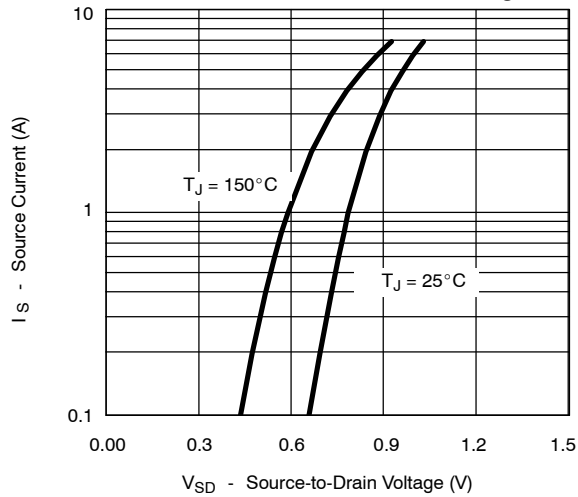

**On-Resistance vs. Gate-to-Source Voltage**

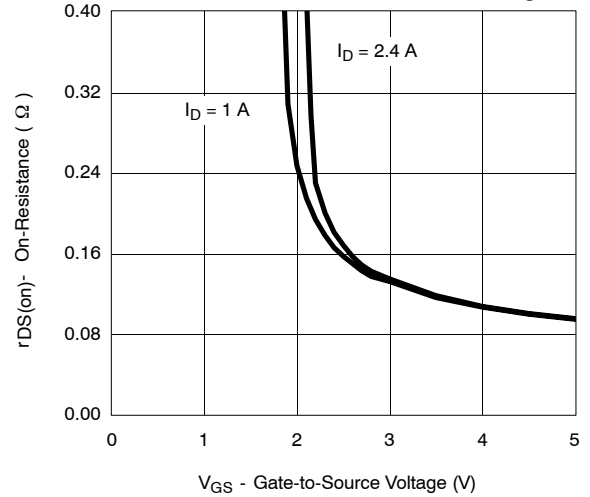

**Threshold Voltage**

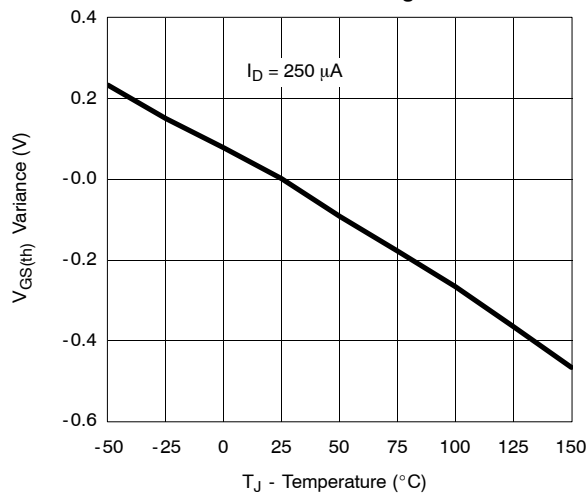

**Single Pulse Power, Junction-to-Ambient**

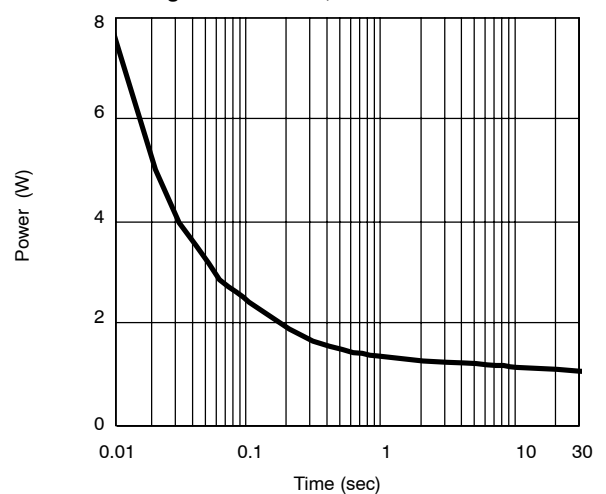

**Normalized Thermal Transient Impedance, Junction-to-Ambient**

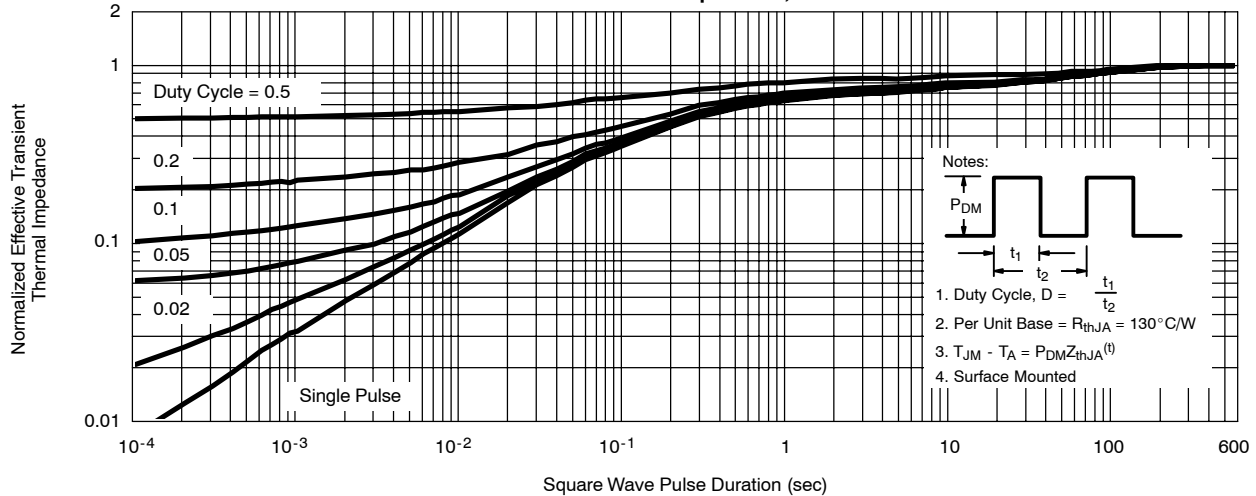



**TYPICAL CHARACTERISTICS (25°C UNLESS NOTED) MOSFET**

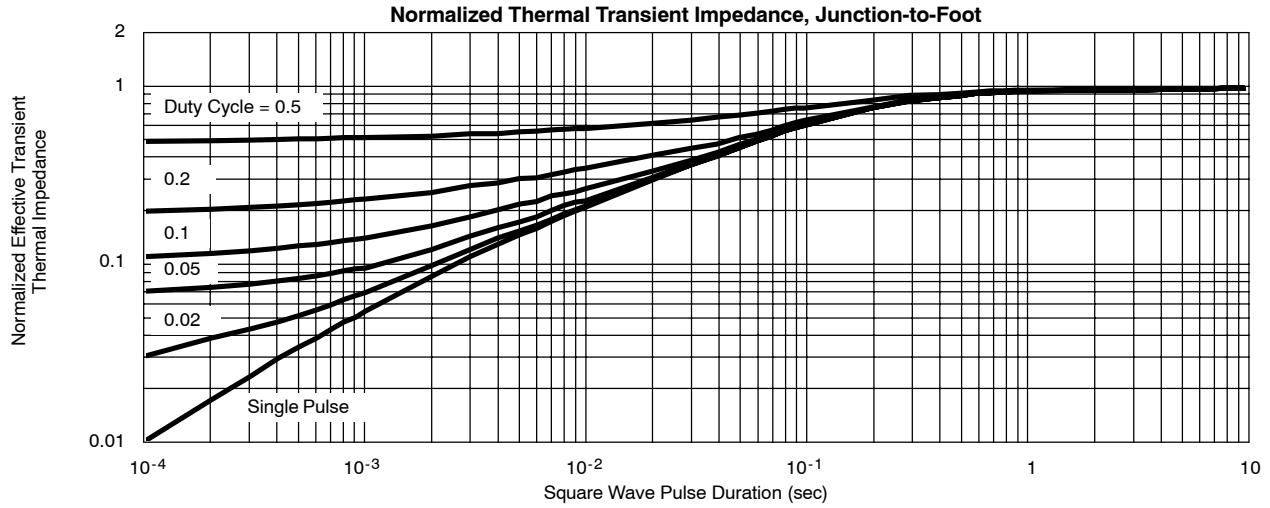

**TYPICAL CHARACTERISTICS (25°C UNLESS NOTED) SCHOTTKY**

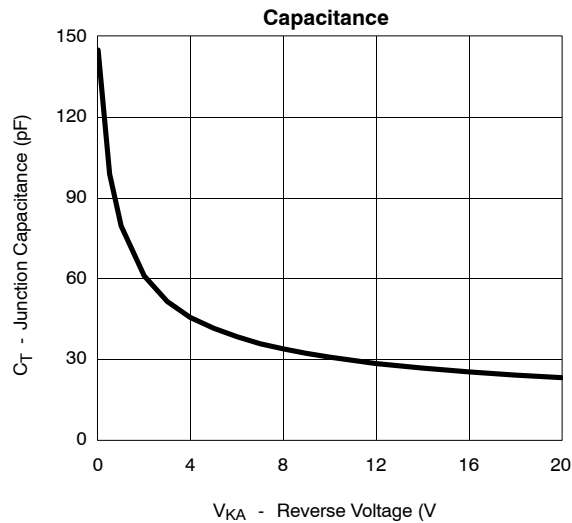
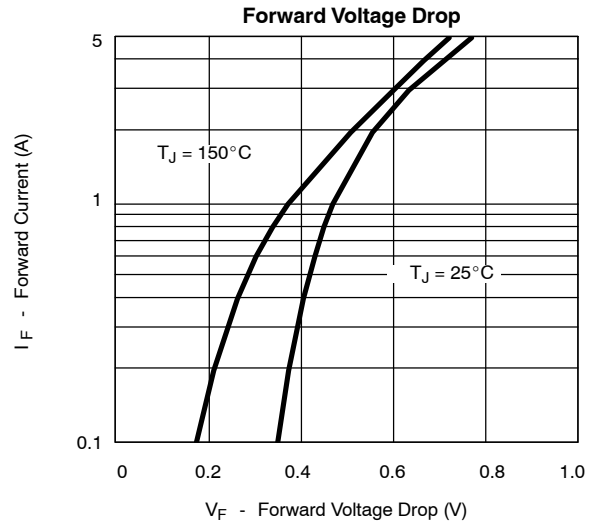
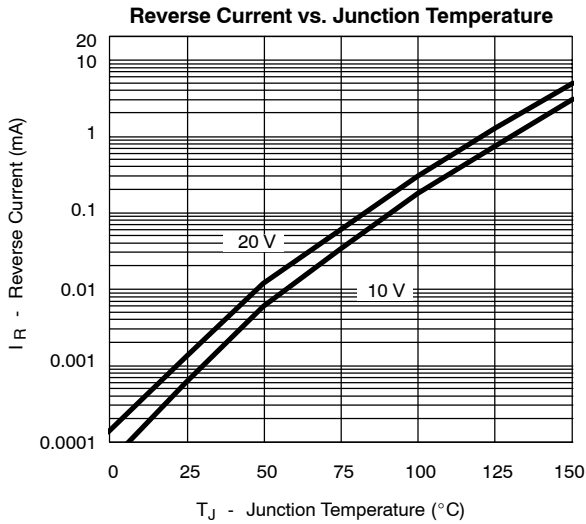

**TYPICAL CHARACTERISTICS (25 °C UNLESS NOTED)**

**SCHOTTKY**

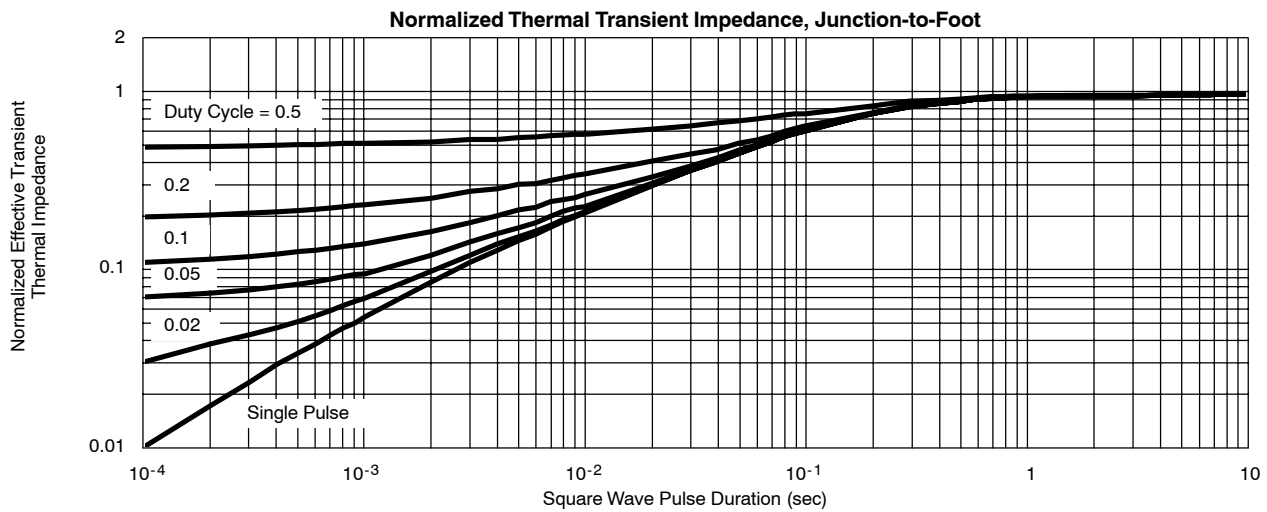
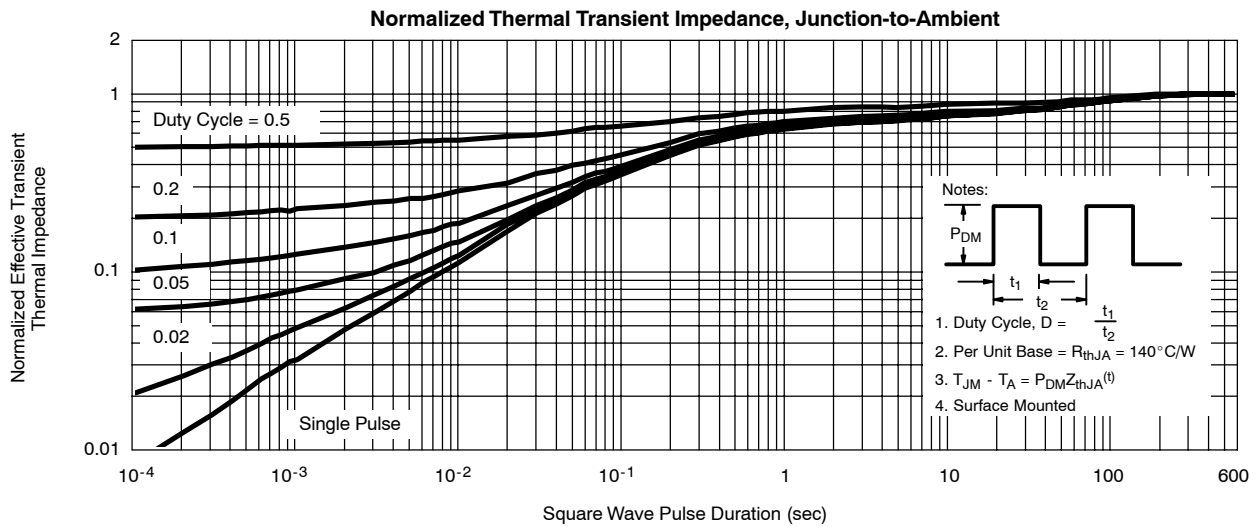



## Disclaimer

All product specifications and data are subject to change without notice.

Vishay Intertechnology, Inc., its affiliates, agents, and employees, and all persons acting on its or their behalf (collectively, "Vishay"), disclaim any and all liability for any errors, inaccuracies or incompleteness contained herein or in any other disclosure relating to any product.

Vishay disclaims any and all liability arising out of the use or application of any product described herein or of any information provided herein to the maximum extent permitted by law. The product specifications do not expand or otherwise modify Vishay's terms and conditions of purchase, including but not limited to the warranty expressed therein, which apply to these products.

No license, express or implied, by estoppel or otherwise, to any intellectual property rights is granted by this document or by any conduct of Vishay.

The products shown herein are not designed for use in medical, life-saving, or life-sustaining applications unless otherwise expressly indicated. Customers using or selling Vishay products not expressly indicated for use in such applications do so entirely at their own risk and agree to fully indemnify Vishay for any damages arising or resulting from such use or sale. Please contact authorized Vishay personnel to obtain written terms and conditions regarding products designed for such applications.

Product names and markings noted herein may be trademarks of their respective owners.