

# HD74HC386

## Quad. 2-input Exclusive-OR Gates

REJ03D0623-0200  
 (Previous ADE-205-502)  
 Rev.2.00  
 Mar 30, 2006

### Features

- High Speed Operation:  $t_{pd} = 11.5 \text{ ns typ (} C_L = 50 \text{ pF)}$
- High Output Current: Fanout of 10 LSTTL Loads
- Wide Operating Voltage:  $V_{CC} = 2 \text{ to } 6 \text{ V}$
- Low Input Current:  $1 \mu\text{A max}$
- Low Quiescent Supply Current:  $I_{CC} \text{ (static)} = 1 \mu\text{A max (} T_a = 25^\circ\text{C)}$
- Ordering Information

Part Name	Package Type	Package Code (Previous Code)	Package Abbreviation	Taping Abbreviation (Quantity)
HD74HC386P	DILP-14 pin	PRDP0014AB-B (DP-14AV)	P	—
HD74HC386FPEL	SOP-14 pin (JEITA)	PRSP0014DF-B (FP-14DAV)	FP	EL (2,000 pcs/reel)
HD74HC386RPEL	SOP-14 pin (JEDEC)	PRSP0014DE-A (FP-14DNV)	RP	EL (2,500 pcs/reel)

Note: Please consult the sales office for the above package availability.

### Function Table

Inputs		Output
A	B	Y
L	L	L
L	H	H
H	L	H
H	H	L

H : High level

L : Low level

## Pin Arrangement

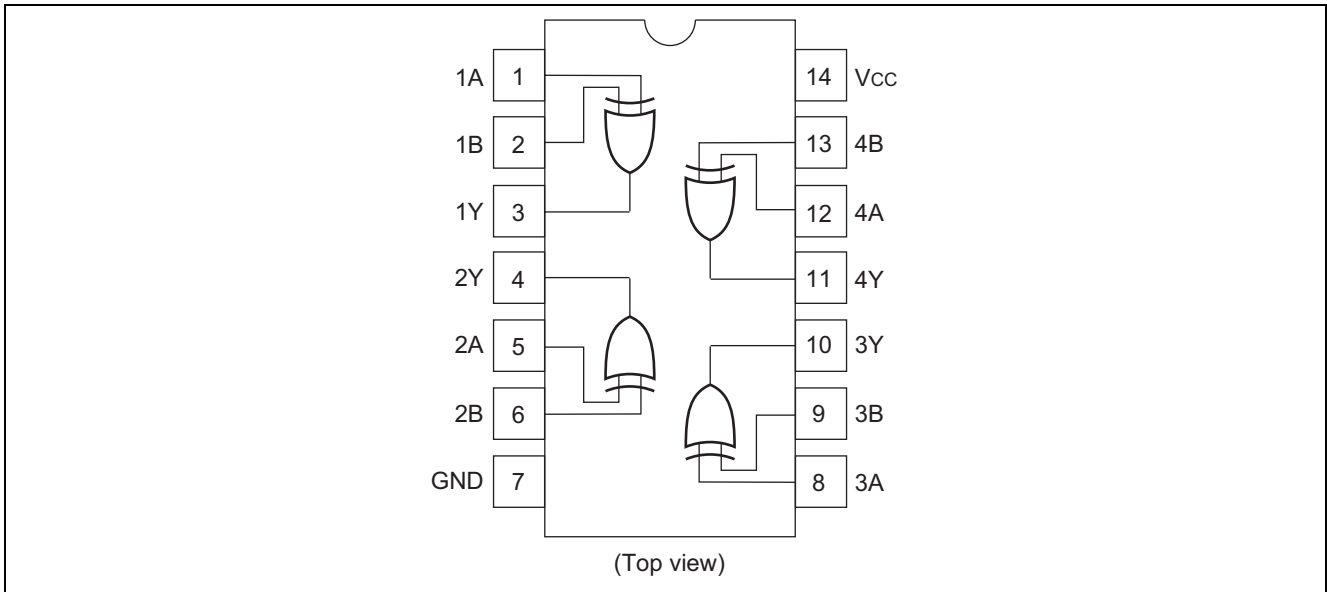

## Absolute Maximum Ratings

Item	Symbol	Ratings	Unit
Supply voltage range	$V_{CC}$	-0.5 to 7.0	V
Input / Output voltage	$V_{IN}, V_{OUT}$	-0.5 to $V_{CC} + 0.5$	V
Input / Output diode current	$I_{IK}, I_{OK}$	$\pm 20$	mA
Output current	$I_O$	$\pm 25$	mA
$V_{CC}, GND$ current	$I_{CC}$ or $I_{GND}$	$\pm 50$	mA
Power dissipation	$P_T$	500	mW
Storage temperature	$T_{stg}$	-65 to +150	$^{\circ}C$

Note: The absolute maximum ratings are values, which must not individually be exceeded, and furthermore, no two of which may be realized at the same time.

## Recommended Operating Conditions

Item	Symbol	Ratings	Unit	Conditions
Supply voltage	$V_{CC}$	2 to 6	V	
Input / Output voltage	$V_{IN}, V_{OUT}$	0 to $V_{CC}$	V	
Operating temperature	$T_a$	-40 to 85	$^{\circ}C$	
Input rise / fall time <sup>*1</sup>	$t_r, t_f$	0 to 1000	ns	$V_{CC} = 2.0\text{ V}$
		0 to 500		$V_{CC} = 4.5\text{ V}$
		0 to 400		$V_{CC} = 6.0\text{ V}$

Note: 1. This item guarantees maximum limit when one input switches.  
Waveform: Refer to test circuit of switching characteristics.

**Electrical Characteristics**

Item	Symbol	V <sub>CC</sub> (V)	Ta = 25°C			Ta = -40 to +85°C		Unit	Test Conditions	
			Min	Typ	Max	Min	Max			
Input voltage	V <sub>IH</sub>	2.0	1.5	—	—	1.5	—	V		
		4.5	3.15	—	—	3.15	—			
		6.0	4.2	—	—	4.2	—			
	V <sub>IL</sub>	2.0	—	—	0.5	—	0.5	V		
		4.5	—	—	1.35	—	1.35			
		6.0	—	—	1.8	—	1.8			
Output voltage	V <sub>OH</sub>	2.0	1.9	2.0	—	1.9	—	V	V <sub>in</sub> = V <sub>IH</sub> or V <sub>IL</sub>	I <sub>OH</sub> = -20 μA
		4.5	4.4	4.5	—	4.4	—			I <sub>OH</sub> = -4 mA
		6.0	5.9	6.0	—	5.9	—			I <sub>OH</sub> = -5.2 mA
		4.5	4.18	—	—	4.13	—			
		6.0	5.68	—	—	5.63	—			
		6.0	5.68	—	—	5.63	—			
	V <sub>OL</sub>	2.0	—	0.0	0.1	—	0.1	V	V <sub>in</sub> = V <sub>IH</sub> or V <sub>IL</sub>	I <sub>OL</sub> = 20 μA
		4.5	—	0.0	0.1	—	0.1			
		6.0	—	0.0	0.1	—	0.1			
		4.5	—	—	0.26	—	0.33			I <sub>OL</sub> = 4 mA
		6.0	—	—	0.26	—	0.33			I <sub>OL</sub> = 5.2 mA
		6.0	—	—	0.26	—	0.33			
Input current	I <sub>in</sub>	6.0	—	—	±0.1	—	±1.0	μA	V <sub>in</sub> = V <sub>CC</sub> or GND	
Quiescent supply current	I <sub>CC</sub>	6.0	—	—	1.0	—	10	μA	V <sub>in</sub> = V <sub>CC</sub> or GND, I <sub>out</sub> = 0 μA	

**Switching Characteristics (C<sub>L</sub> = 50 pF, Input t<sub>r</sub> = t<sub>f</sub> = 6 ns)**

Item	Symbol	V <sub>CC</sub> (V)	Ta = 25°C			Ta = -40 to +85°C		Unit	Test Conditions	
			Min	Typ	Max	Min	Max			
Propagation delay time	t <sub>PLH</sub>	2.0	—	—	120	—	150	ns		
		4.5	—	12	24	—	30			
		6.0	—	—	20	—	26			
	t <sub>PHL</sub>	2.0	—	—	120	—	150	ns		
		4.5	—	12	24	—	30			
		6.0	—	—	20	—	26			
Output rise time	t <sub>TLH</sub>	2.0	—	—	75	—	95	ns		
		4.5	—	7	15	—	19			
		6.0	—	—	13	—	16			
Output fall time	t <sub>THL</sub>	2.0	—	—	75	—	95	ns		
		4.5	—	7	15	—	19			
		6.0	—	—	13	—	16			
Input capacitance	C <sub>in</sub>	—	—	5	10	—	10	pF		

Test Circuit



Waveforms

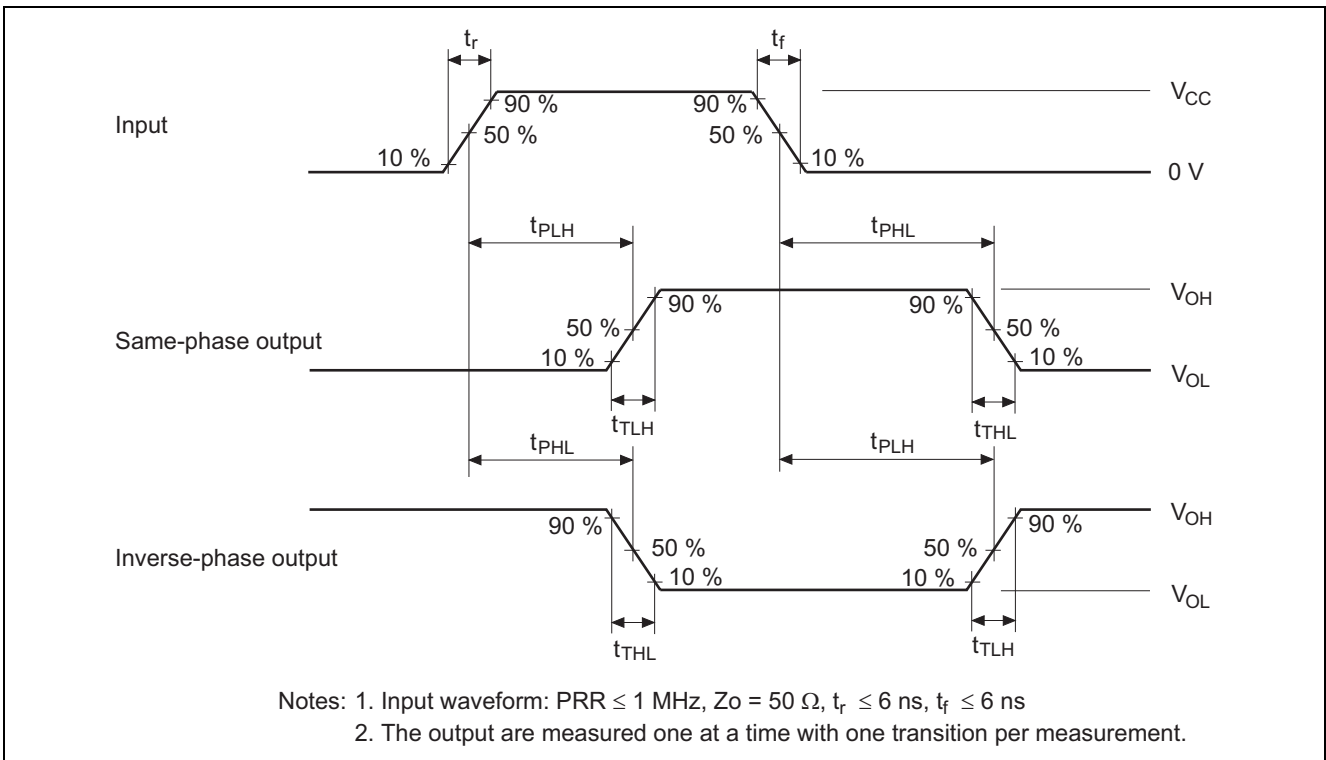

Package Dimensions

JEITA Package Code	RENESAS Code	Previous Code	MASS[Typ.]
P-DIP14-6.3x19.2-2.54	PRDP0014AB-B	DP-14AV	0.97g

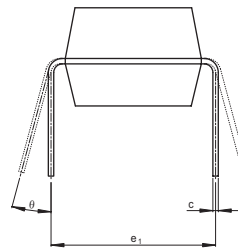
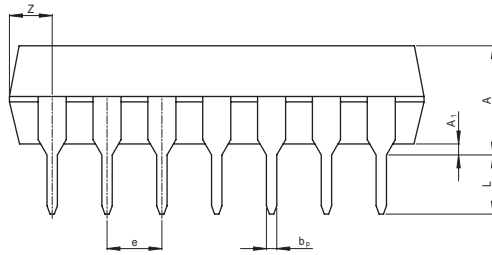
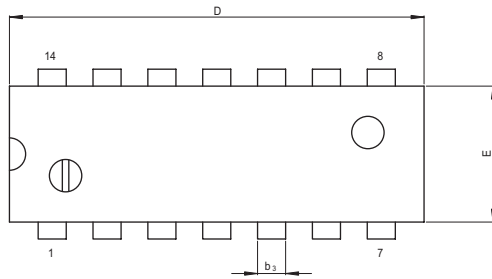

(Ni/Pd/Au plating)

Reference Symbol	Dimension in Millimeters		
	Min	Nom	Max
e <sub>1</sub>	—	7.62	—
D	—	19.2	20.32
E	—	6.3	7.4
A	—	—	5.06
A <sub>1</sub>	0.51	—	—
b <sub>p</sub>	0.40	0.48	0.56
b <sub>3</sub>	—	1.30	—
c	0.19	0.25	0.31
θ	0°	—	15°
e	2.29	2.54	2.79
Z	—	—	2.39
L	2.54	—	—

JEITA Package Code	RENESAS Code	Previous Code	MASS[Typ.]
P-SOP14-5.5x10.06-1.27	PRSP0014DF-B	FP-14DAV	0.23g

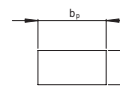
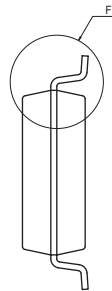
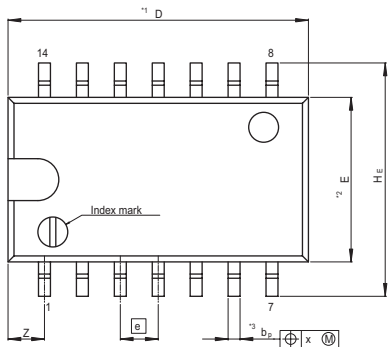

Terminal cross section (Ni/Pd/Au plating)

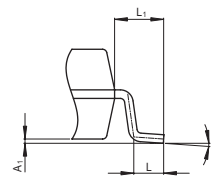
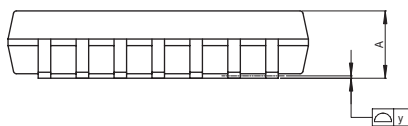

Detail F

NOTE)  
 1. DIMENSIONS\*\*1 (Nom)\*AND\*\*2 DO NOT INCLUDE MOLD FLASH.  
 2. DIMENSION\*\*3\*DOES NOT INCLUDE TRIM OFFSET.

Reference Symbol	Dimension in Millimeters		
	Min	Nom	Max
D	—	10.06	10.5
E	—	5.50	—
A <sub>2</sub>	—	—	—
A <sub>1</sub>	0.00	0.10	0.20
A	—	—	2.20
b <sub>p</sub>	0.34	0.40	0.46
b <sub>1</sub>	—	—	—
c	0.15	0.20	0.25
c <sub>1</sub>	—	—	—
θ	0°	—	8°
H <sub>E</sub>	7.50	7.80	8.00
Ⓧ	—	1.27	—
x	—	—	0.12
y	—	—	0.15
Z	—	—	1.42
L	0.50	0.70	0.90
L <sub>1</sub>	—	1.15	—

JEITA Package Code	RENESAS Code	Previous Code	MASS[Typ.]
P-SOP14-3.95x8.65-1.27	PRSP0014DE-A	FP-14DNV	0.13g

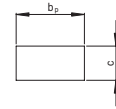
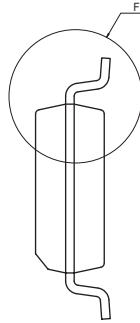
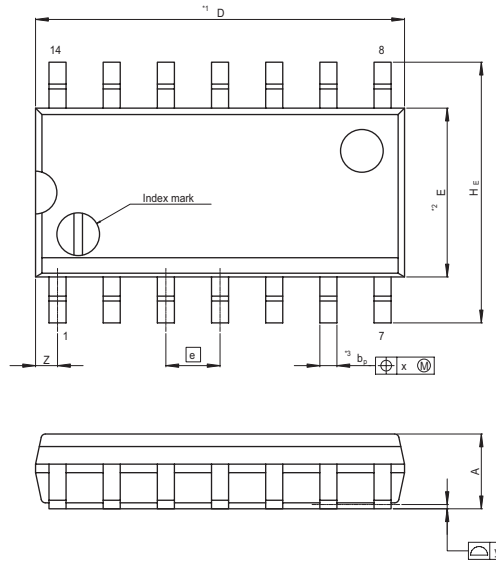

Terminal cross section  
( Ni/Pd/Au plating )

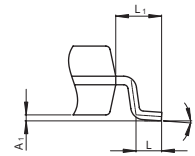

Detail F

NOTE)  
1. DIMENSIONS\*\*1 (Nom)\*\*AND\*\*2\*  
DO NOT INCLUDE MOLD FLASH.  
2. DIMENSION\*\*3\*DOES NOT  
INCLUDE TRIM OFFSET.

Reference Symbol	Dimension in Millimeters		
	Min	Nom	Max
D	—	8.65	9.05
E	—	3.95	—
A <sub>2</sub>	—	—	—
A <sub>1</sub>	0.10	0.14	0.25
A	—	—	1.75
b <sub>p</sub>	0.34	0.40	0.46
b <sub>1</sub>	—	—	—
c	0.15	0.20	0.25
c <sub>1</sub>	—	—	—
θ	0°	—	8°
H <sub>E</sub>	5.80	6.10	6.20
Ⓜ	—	1.27	—
x	—	—	0.25
y	—	—	0.15
Z	—	—	0.635
L	0.40	0.60	1.27
L <sub>1</sub>	—	1.08	—

**Keep safety first in your circuit designs!**

1. Renesas Technology Corp. puts the maximum effort into making semiconductor products better and more reliable, but there is always the possibility that trouble may occur with them. Trouble with semiconductors may lead to personal injury, fire or property damage. Remember to give due consideration to safety when making your circuit designs, with appropriate measures such as (i) placement of substitutive, auxiliary circuits, (ii) use of nonflammable material or (iii) prevention against any malfunction or mishap.

**Notes regarding these materials**

1. These materials are intended as a reference to assist our customers in the selection of the Renesas Technology Corp. product best suited to the customer's application; they do not convey any license under any intellectual property rights, or any other rights, belonging to Renesas Technology Corp. or a third party.
2. Renesas Technology Corp. assumes no responsibility for any damage, or infringement of any third-party's rights, originating in the use of any product data, diagrams, charts, programs, algorithms, or circuit application examples contained in these materials.
3. All information contained in these materials, including product data, diagrams, charts, programs and algorithms represents information on products at the time of publication of these materials, and are subject to change by Renesas Technology Corp. without notice due to product improvements or other reasons. It is therefore recommended that customers contact Renesas Technology Corp. or an authorized Renesas Technology Corp. product distributor for the latest product information before purchasing a product listed herein.  
The information described here may contain technical inaccuracies or typographical errors.  
Renesas Technology Corp. assumes no responsibility for any damage, liability, or other loss rising from these inaccuracies or errors.  
Please also pay attention to information published by Renesas Technology Corp. by various means, including the Renesas Technology Corp. Semiconductor home page (<http://www.renesas.com>).
4. When using any or all of the information contained in these materials, including product data, diagrams, charts, programs, and algorithms, please be sure to evaluate all information as a total system before making a final decision on the applicability of the information and products. Renesas Technology Corp. assumes no responsibility for any damage, liability or other loss resulting from the information contained herein.
5. Renesas Technology Corp. semiconductors are not designed or manufactured for use in a device or system that is used under circumstances in which human life is potentially at stake. Please contact Renesas Technology Corp. or an authorized Renesas Technology Corp. product distributor when considering the use of a product contained herein for any specific purposes, such as apparatus or systems for transportation, vehicular, medical, aerospace, nuclear, or undersea repeater use.
6. The prior written approval of Renesas Technology Corp. is necessary to reprint or reproduce in whole or in part these materials.
7. If these products or technologies are subject to the Japanese export control restrictions, they must be exported under a license from the Japanese government and cannot be imported into a country other than the approved destination.  
Any diversion or reexport contrary to the export control laws and regulations of Japan and/or the country of destination is prohibited.
8. Please contact Renesas Technology Corp. for further details on these materials or the products contained therein.



**RENESAS SALES OFFICES**

<http://www.renesas.com>

Refer to "<http://www.renesas.com/en/network>" for the latest and detailed information.

**Renesas Technology America, Inc.**

450 Holger Way, San Jose, CA 95134-1368, U.S.A  
Tel: <1> (408) 382-7500, Fax: <1> (408) 382-7501

**Renesas Technology Europe Limited**

Dukes Meadow, Millboard Road, Bourne End, Buckinghamshire, SL8 5FH, U.K.  
Tel: <44> (1628) 585-100, Fax: <44> (1628) 585-900

**Renesas Technology (Shanghai) Co., Ltd.**

Unit 204, 205, AZIACenter, No.1233 Lujiazui Ring Rd, Pudong District, Shanghai, China 200120  
Tel: <86> (21) 5877-1818, Fax: <86> (21) 6887-7898

**Renesas Technology Hong Kong Ltd.**

7th Floor, North Tower, World Finance Centre, Harbour City, 1 Canton Road, Tsimshatsui, Kowloon, Hong Kong  
Tel: <852> 2265-6688, Fax: <852> 2730-6071

**Renesas Technology Taiwan Co., Ltd.**

10th Floor, No.99, Fushing North Road, Taipei, Taiwan  
Tel: <886> (2) 2715-2888, Fax: <886> (2) 2713-2999

**Renesas Technology Singapore Pte. Ltd.**

1 Harbour Front Avenue, #06-10, Keppel Bay Tower, Singapore 098632  
Tel: <65> 6213-0200, Fax: <65> 6278-8001

**Renesas Technology Korea Co., Ltd.**

Kukje Center Bldg. 18th Fl., 191, 2-ka, Hangang-ro, Yongsan-ku, Seoul 140-702, Korea  
Tel: <82> (2) 796-3115, Fax: <82> (2) 796-2145

**Renesas Technology Malaysia Sdn. Bhd**

Unit 906, Block B, Menara Amcorp, Amcorp Trade Centre, No.18, Jalan Persiaran Barat, 46050 Petaling Jaya, Selangor Darul Ehsan, Malaysia  
Tel: <603> 7955-9390, Fax: <603> 7955-9510