

Schottky Rectifier, 2 x 15 A

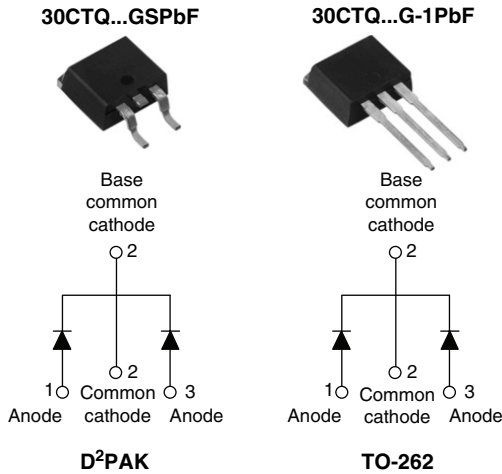

FEATURES

- 175 °C T_J operation
- Center tap configuration
- Low forward voltage drop
- High frequency operation
- High purity, high temperature epoxy encapsulation for enhanced mechanical strength and moisture resistance
- Guard ring for enhanced ruggedness and long term reliability
- Lead (Pb)-free ("PbF" suffix)
- Designed and qualified for industrial level



Available
RoHS*
COMPLIANT

DESCRIPTION

This center tap Schottky rectifier series has been optimized for low reverse leakage at high temperature. The proprietary barrier technology allows for reliable operation up to 175 °C junction temperature. Typical applications are in switching power supplies, converters, freewheeling diodes, and reverse battery protection.

PRODUCT SUMMARY

| | |
|--------------------|----------|
| I _{F(AV)} | 2 x 15 A |
| V _R | 80/100 V |

MAJOR RATINGS AND CHARACTERISTICS

| SYMBOL | CHARACTERISTICS | VALUES | UNITS |
|--------------------|---|-------------|-------|
| I _{F(AV)} | Rectangular waveform | 30 | A |
| V _{RRM} | | 80/100 | V |
| I _{FSM} | t _p = 5 μs sine | 650 | A |
| V _F | 15 Apk, T _J = 125 °C (per leg) | 0.69 | V |
| T _J | Range | - 55 to 175 | °C |

VOLTAGE RATINGS

| PARAMETER | SYMBOL | 30CTQ080GSPbF 30CTQ080G-1PbF | 30CTQ100GSPbF 30CTQ100G-1PbF | UNITS |
|--------------------------------------|------------------|---------------------------------|---------------------------------|-------|
| Maximum DC reverse voltage | V _R | 80 | 100 | V |
| Maximum working peak reverse voltage | V _{RWM} | | | |

ABSOLUTE MAXIMUM RATINGS

| PARAMETER | SYMBOL | TEST CONDITIONS | VALUES | UNITS |
|---|--------------------|--|--------|-------|
| Maximum average forward current per device See fig. 5 | I _{F(AV)} | 50 % duty cycle at T _C = 129 °C, rectangular waveform | 30 | A |
| | | | 15 | |
| Maximum peak one cycle non-repetitive surge current per leg See fig. 7 | I _{FSM} | 5 μs sine or 3 μs rect. pulse | 650 | |
| | | 10 ms sine or 6 ms rect. pulse | 210 | |
| Non-repetitive avalanche energy per leg | E _{AS} | T _J = 25 °C, I _{AS} = 0.50 A, L = 60 mH | 7.50 | mJ |
| Repetitive avalanche current per leg | I _{AR} | Current decaying linearly to zero in 1 μs Frequency limited by T _J maximum V _A = 1.5 x V _R typical | 0.50 | A |

* Pb containing terminations are not RoHS compliant, exemptions may apply

| ELECTRICAL SPECIFICATIONS | | | | | |
|---|----------------|---|-----------------------------------|--------|------------------|
| PARAMETER | SYMBOL | TEST CONDITIONS | | VALUES | UNITS |
| Maximum forward voltage drop per leg See fig. 1 | $V_{FM}^{(1)}$ | 15 A | $T_J = 25\text{ }^\circ\text{C}$ | 0.86 | V |
| | | 30 A | | 1.05 | |
| | | 15 A | $T_J = 125\text{ }^\circ\text{C}$ | 0.69 | |
| | | 30 A | | 0.82 | |
| Maximum reverse leakage current per leg See fig. 2 | $I_{RM}^{(1)}$ | $T_J = 25\text{ }^\circ\text{C}$ | $V_R = \text{Rated } V_R$ | 0.28 | mA |
| | | $T_J = 125\text{ }^\circ\text{C}$ | | 7.0 | |
| Maximum junction capacitance per leg | C_T | $V_R = 5\text{ }V_{DC}$ (test signal range 100 kHz to 1 MHz) $25\text{ }^\circ\text{C}$ | | 500 | pF |
| Typical series inductance per leg | L_S | Measured lead to lead 5 mm from package body | | 8.0 | nH |
| Maximum voltage rate of change | dV/dt | Rated V_R | | 10 000 | V/ μs |

Note

(1) Pulse width < 300 μs , duty cycle < 2 %

| THERMAL - MECHANICAL SPECIFICATIONS | | | | | |
|--|----------------|--------------------------------------|--|-------------|------------------------|
| PARAMETER | SYMBOL | TEST CONDITIONS | | VALUES | UNITS |
| Maximum junction and storage temperature range | T_J, T_{Stg} | | | - 55 to 175 | $^\circ\text{C}$ |
| Maximum thermal resistance, junction to case per leg | R_{thJC} | DC operation | | 3.25 | $^\circ\text{C/W}$ |
| Maximum thermal resistance, junction to case per package | | | | 1.63 | |
| Typical thermal resistance, case to heatsink | R_{thCS} | Mounting surface, smooth and greased | | 0.50 | |
| Approximate weight | | | | 2 | g |
| | | | | 0.07 | oz. |
| Mounting torque | minimum | | | 6 (5) | kgf · cm (lbf · in) |
| | maximum | | | 12 (10) | |
| Marking device | | Case style D ² PAK | | 30CTQ080GS | |
| | | | | 30CTQ100GS | |
| | | Case style TO-262 | | 30CTQ080G-1 | |
| | | | | 30CTQ100G-1 | |

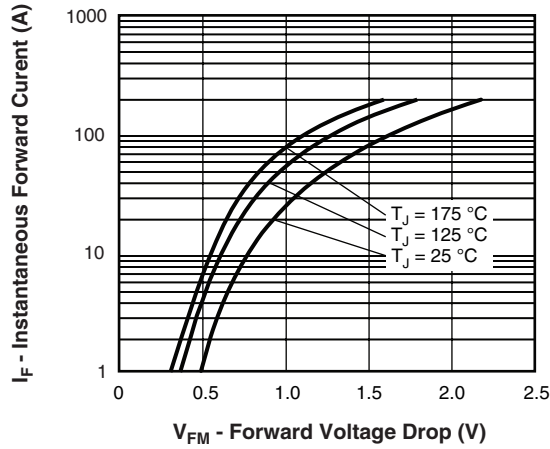

Fig. 1 - Maximum Forward Voltage Drop Characteristics (Per Leg)

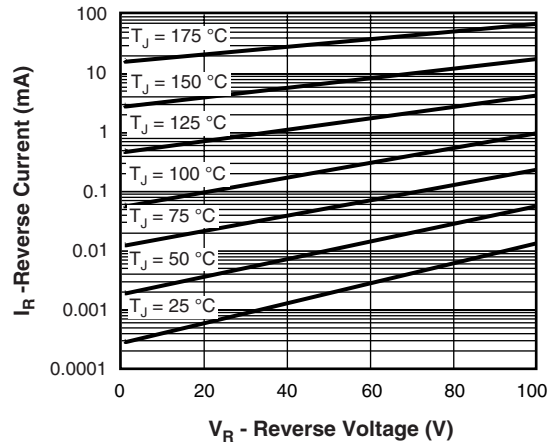

Fig. 2 - Typical Values of Reverse Current vs. Reverse Voltage (Per Leg)

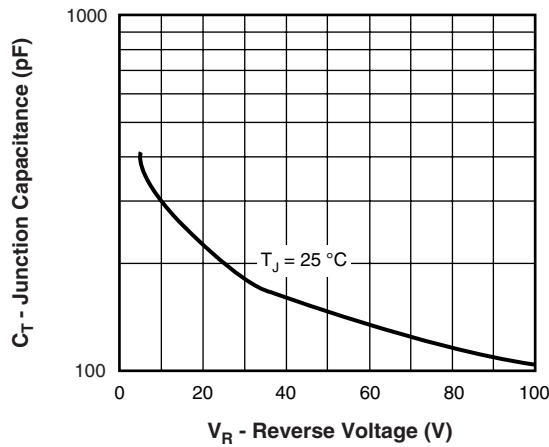

Fig. 3 - Typical Junction Capacitance vs. Reverse Voltage (Per Leg)

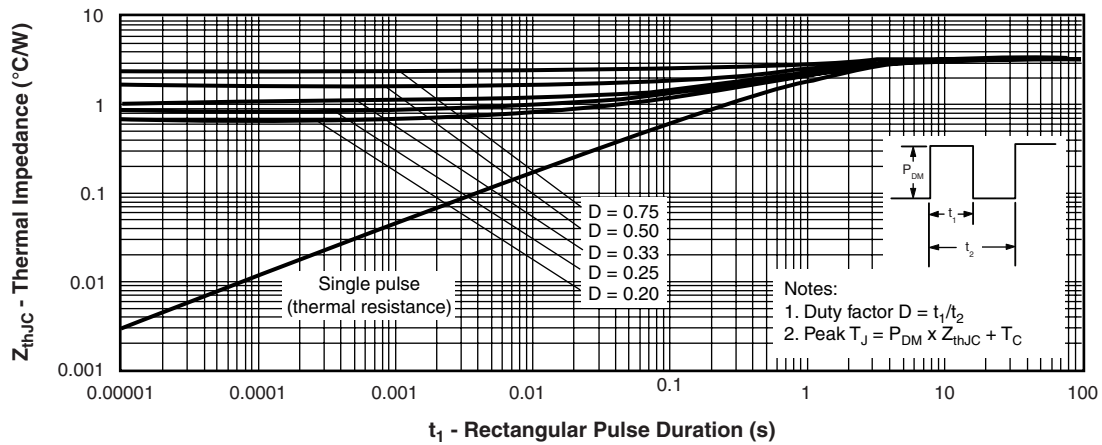

Fig. 4 - Maximum Thermal Impedance Z_{thJC} Characteristics (Per Leg)

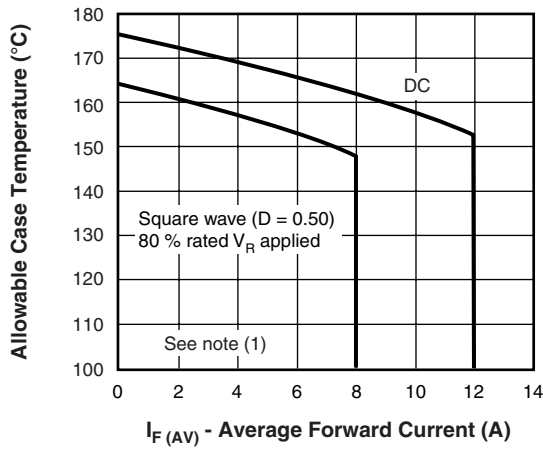

Fig. 5 - Maximum Allowable Case Temperature vs. Average Forward Current (Per Leg)

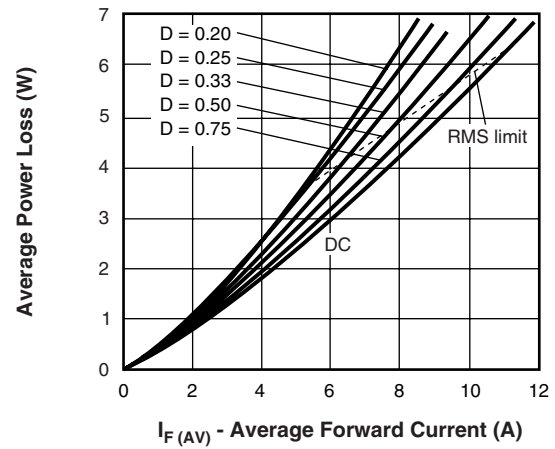

Fig. 6 - Forward Power Loss Characteristics (Per Leg)

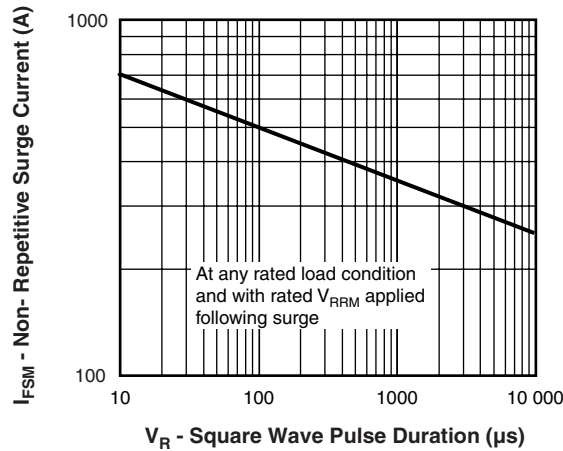

Fig. 7 - Maximum Non-Repetitive Surge Current (Per Leg)

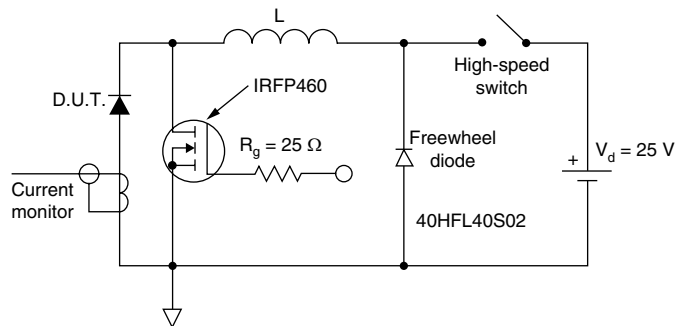

Fig. 8 - Unclamped Inductive Test Circuit

Note

- (1) Formula used: $T_C = T_J - (P_d + P_{d_{REV}}) \times R_{thJC}$;
- P_d = Forward power loss = $I_{F(AV)} \times V_{FM}$ at $(I_{F(AV)}/D)$ (see fig. 6);
- $P_{d_{REV}}$ = Inverse power loss = $V_{R1} \times I_R (1 - D)$; I_R at $V_{R1} = 10$ V



ORDERING INFORMATION TABLE

| | | | | | | | | | |
|-------------|-----------|----------|----------|----------|------------|----------|----------|------------|------------|
| Device code | 30 | C | T | Q | 100 | G | S | TRL | PbF |
| | ① | ② | ③ | ④ | ⑤ | ⑥ | ⑦ | ⑧ | ⑨ |

- 1** - Current rating (30 = 30 A)
- 2** - C = Common cathode
- 3** - T = TO-220, TO-262, D²PAK
- 4** - Q = Schottky "Q" series
- 5** - Voltage ratings 080 = 80 V
100 = 100 V
- 6** - G = Schottky generation
- 7** -
 - -1 = TO-262
 - S = D²PAK
- 8** -
 - None = Tube (50 pieces)
 - TRL = Tape and reel (left oriented - for D²PAK only)
 - TRR = Tape and reel (right oriented - for D²PAK only)
- 9** -
 - None = Standard production
 - PbF = Lead (Pb)-free (for D²PAK tube and TO-262)
 - P = Lead (Pb)-free (for D²PAK TRL and TRR)

| LINKS TO RELATED DOCUMENTS | |
|----------------------------|---|
| Dimensions | http://www.vishay.com/doc?95014 |
| Part marking information | http://www.vishay.com/doc?95008 |
| Packaging information | http://www.vishay.com/doc?95032 |



Disclaimer

All product specifications and data are subject to change without notice.

Vishay Intertechnology, Inc., its affiliates, agents, and employees, and all persons acting on its or their behalf (collectively, "Vishay"), disclaim any and all liability for any errors, inaccuracies or incompleteness contained herein or in any other disclosure relating to any product.

Vishay disclaims any and all liability arising out of the use or application of any product described herein or of any information provided herein to the maximum extent permitted by law. The product specifications do not expand or otherwise modify Vishay's terms and conditions of purchase, including but not limited to the warranty expressed therein, which apply to these products.

No license, express or implied, by estoppel or otherwise, to any intellectual property rights is granted by this document or by any conduct of Vishay.

The products shown herein are not designed for use in medical, life-saving, or life-sustaining applications unless otherwise expressly indicated. Customers using or selling Vishay products not expressly indicated for use in such applications do so entirely at their own risk and agree to fully indemnify Vishay for any damages arising or resulting from such use or sale. Please contact authorized Vishay personnel to obtain written terms and conditions regarding products designed for such applications.

Product names and markings noted herein may be trademarks of their respective owners.