

**Pb-free
HEAT**



AN1102W

Surface Mount IRED/Inner Lens Type

Features

Package	3216 type, Water clear epoxy
Product features	<ul style="list-style-type: none"> • Outer Dimension 3.0 x 1.5 x 1.5mm (L x W x H) • Inner Lenz type • Total Output Power : 2mW TYP. (I_F=20mA) • Lead-free soldering compatible • RoHS compliant
Peak Wavelength	950nm
Half Intensity Angle	$\theta_x = 60 \text{ deg.}, \theta_y = 90 \text{ deg.}$
Die materials	GaAs
Rank grouping parameter	Sorted by radiant intensity per rank taping
Assembly method	Auto pick & place machine (Auto Mounter)
Soldering methods	Reflow soldering and manual soldering ※Please refer to Soldering Conditions about soldering.
Taping and reel	2,500pcs per reel in a 8mm width tape. (Standard) Reel diameter: $\phi 180\text{mm}$
ESD	2kV (HBM)

Recommended Applications

Car Audio, Electric Household Appliances, OA/FA, PC/Peripheral Equipment, Other General Applications

Absolute Maximum Ratings

(Ta=25°C)

Item	Symbol	Absolute Maximum Ratings	Unit
Power Dissipation	Pd	75	mW
Forward Current	I _F	50	mA
Pulse Forward Current ※1	I _{FRM}	300	mA
Derating (Ta=25°C or higher)	ΔI _F	0.67	mA/°C
	ΔI _{FRM}	4	mA/°C
Reverse Voltage	V _R	5	V
Operating Temperature	T _{opr}	-30~+85	°C
Storage Temperature	T _{stg}	-40~+100	°C

※1 IFRM Measurement condition : Pulse Width ≤ 100 μs, Duty ≤ 1/100

Electro-Optical Characteristics

(Ta=25°C)

Item	Conditions	Symbol	Characteristics		Unit
			TYP.	MAX.	
Forward Voltage	I _F =20mA	V _F	TYP.	1.22	V
			MAX.	1.4	
Reverse Current	V _R =5V	I _R	MAX.	10	μA
Radiant Intensity	I _F =20mA	I _E	MIN.	0.5	mW/sr
			TYP.	0.8	
Total Output Power	I _F =20mA	P _o	TYP.	2	mW
Peak Wavelength	I _F =20mA	λ _p	TYP.	950	nm
Spectral Half-width	I _F =20mA	Δλ	TYP.	45	nm
Half Intensity Angle	I _F =20mA	2θ 1/2	TYP.	60(θ x)	deg.
				90(θ y)	
Cut-off Frequency	I _F =20mA _{DC} ± 5mA, -3db from 0.1MHz	fc	MIN.	-	MHz
			TYP.	0.5	
Response Time	I _F =20mA	tr/tf	TYP.	700	ns

Radiant Intensity Rank

(Ta=25°C)

Rank	I _E (mW/sr)		Condition
	MIN.	MAX.	
A	0.5	1.0	I _F = 20mA
B	0.7	1.4	
C	1.0	2.0	
D	1.4	2.8	
E	2.0	-	

Please contact our sales staff concerning rank designation.

Technical Data

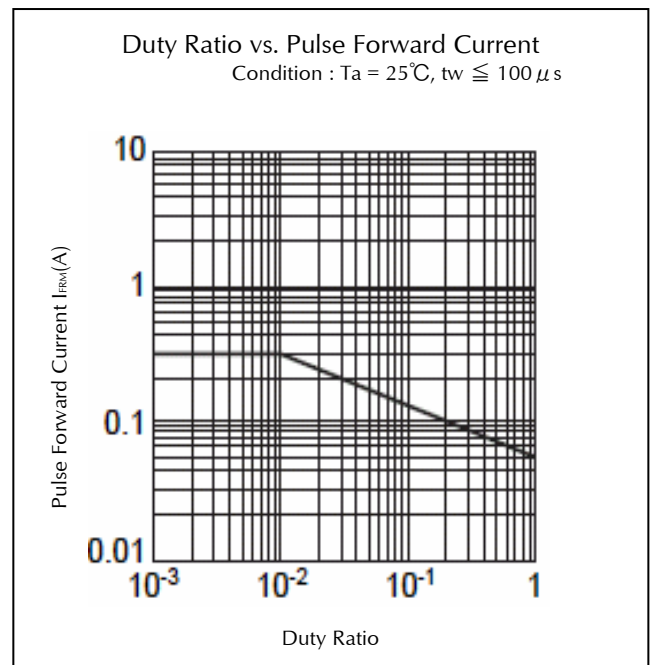
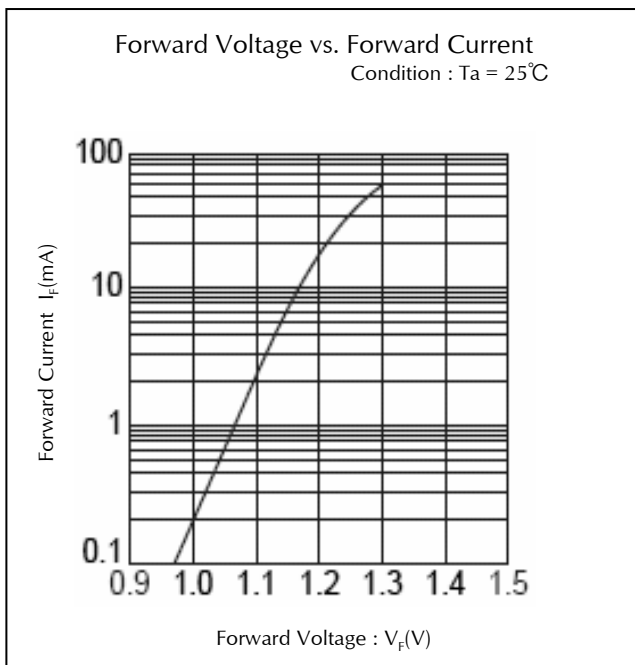
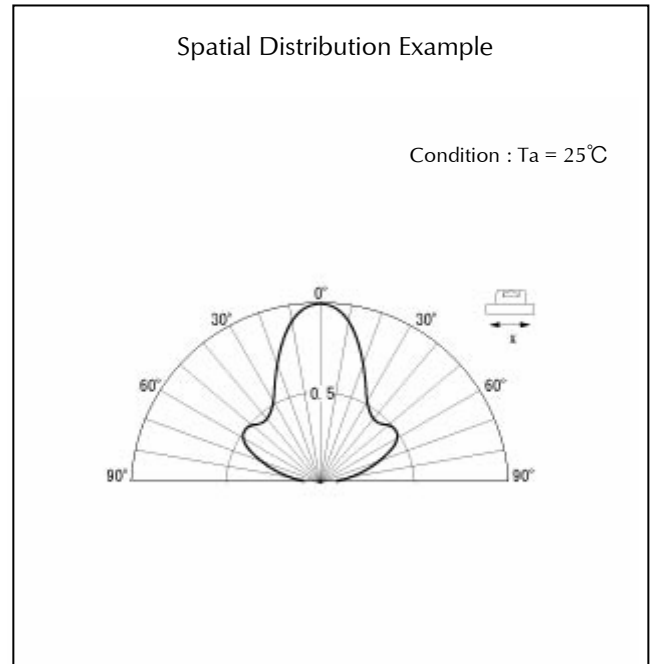
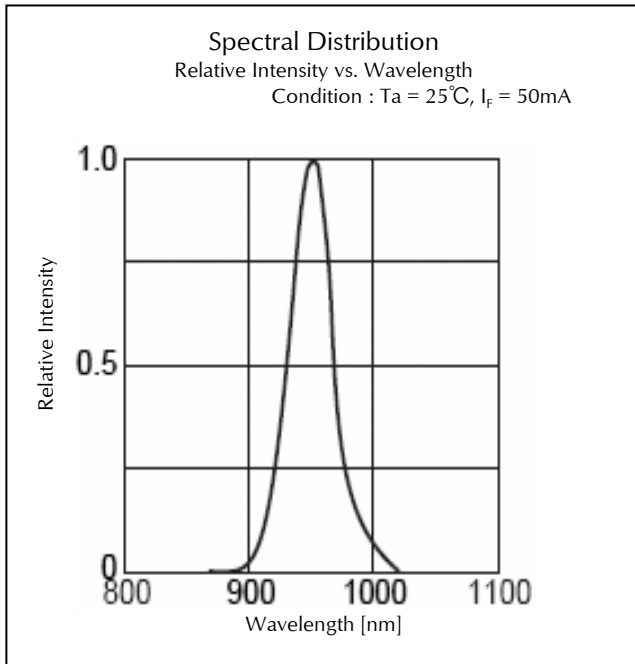

Technical Data

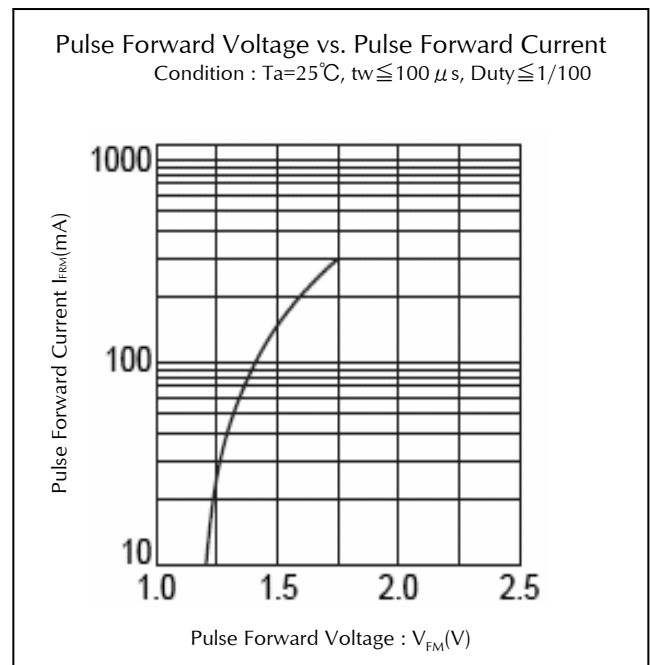
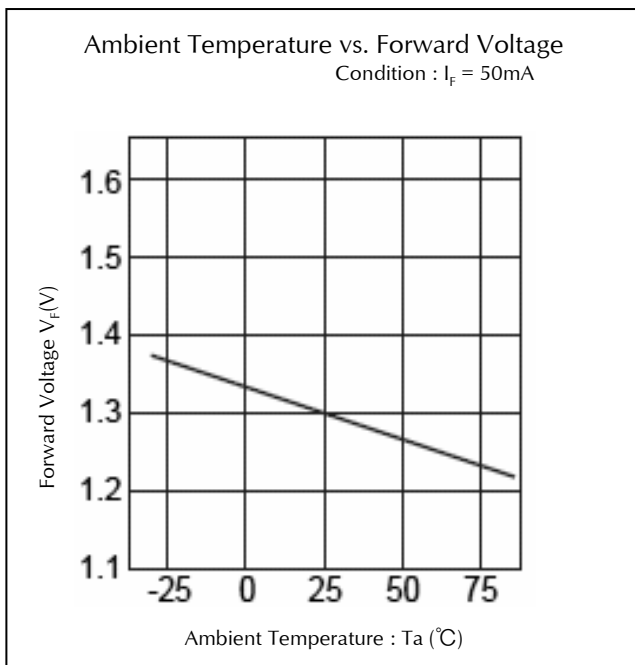
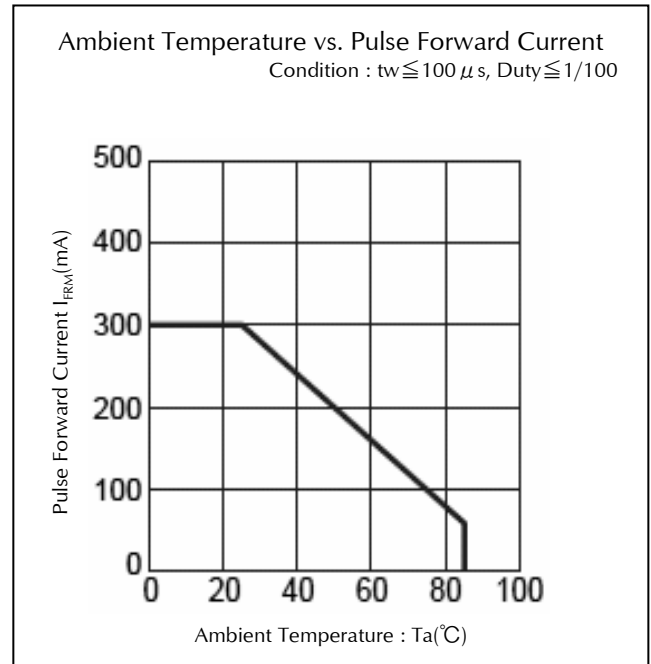
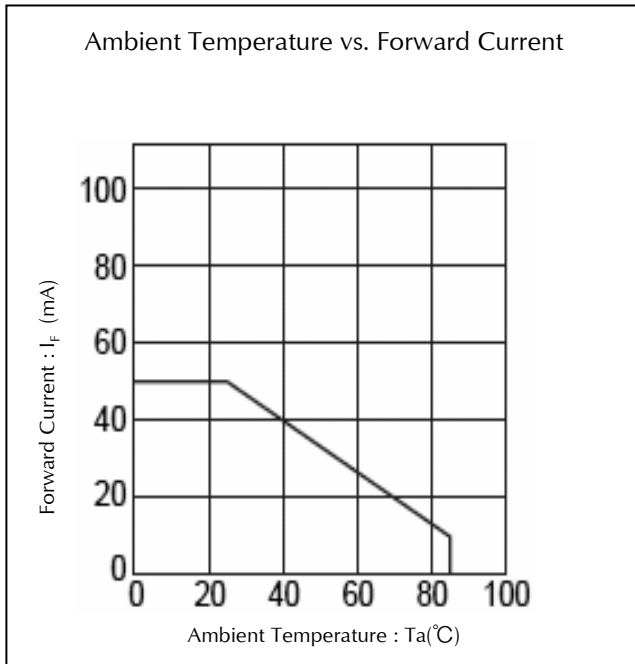

Technical Data

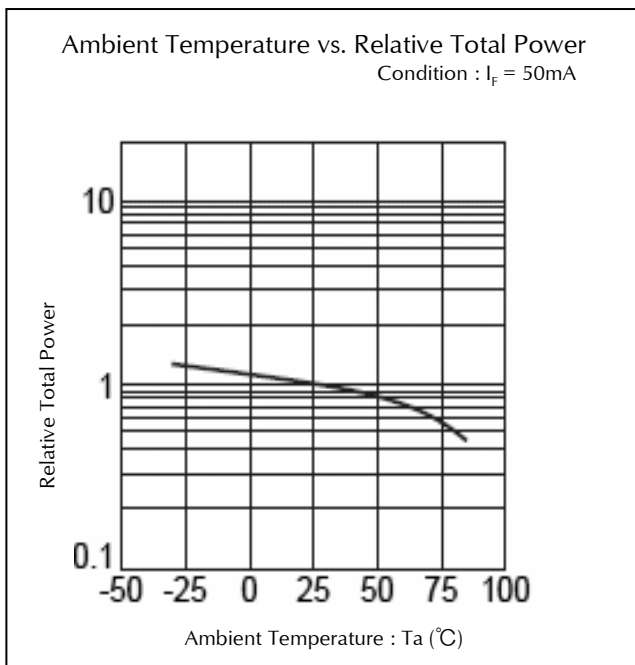
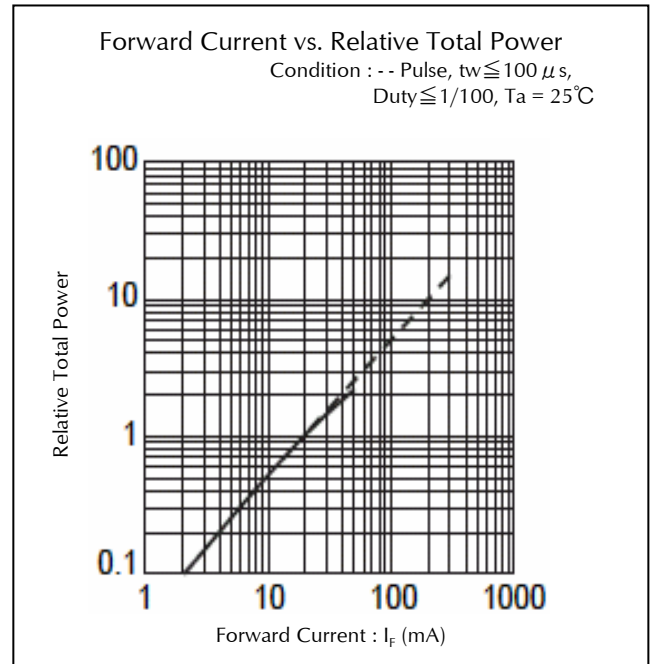
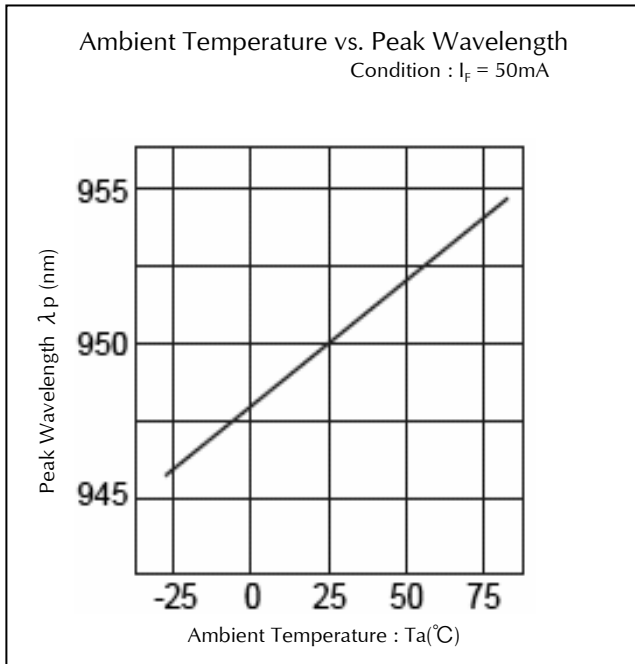

Package Dimensions

(Unit: mm)

Weight: (7.80)mg

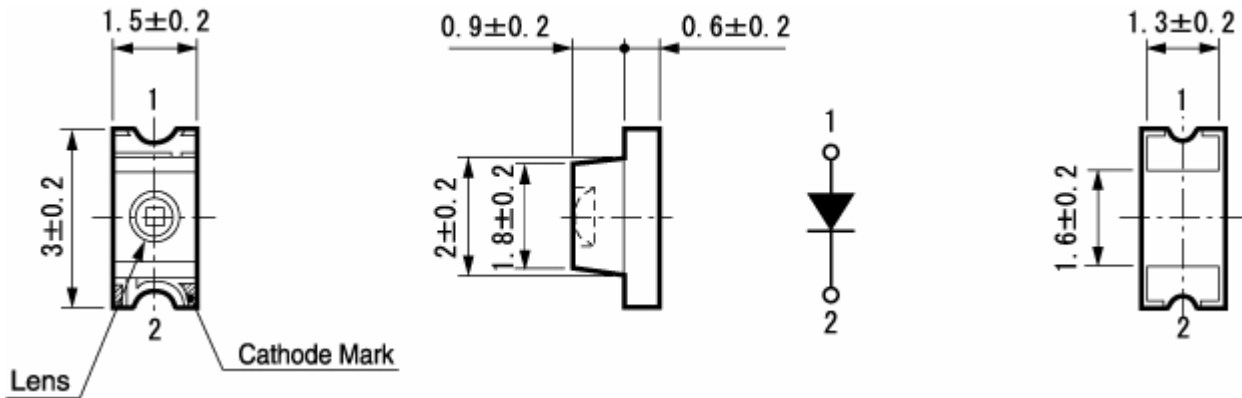

Recommended Soldering Pattern

(Unit: mm)

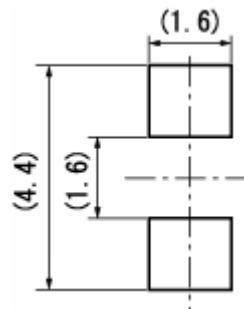

Taping Specification

(Unit: mm)

Quantity: 2,500pcs/ reel (standard)

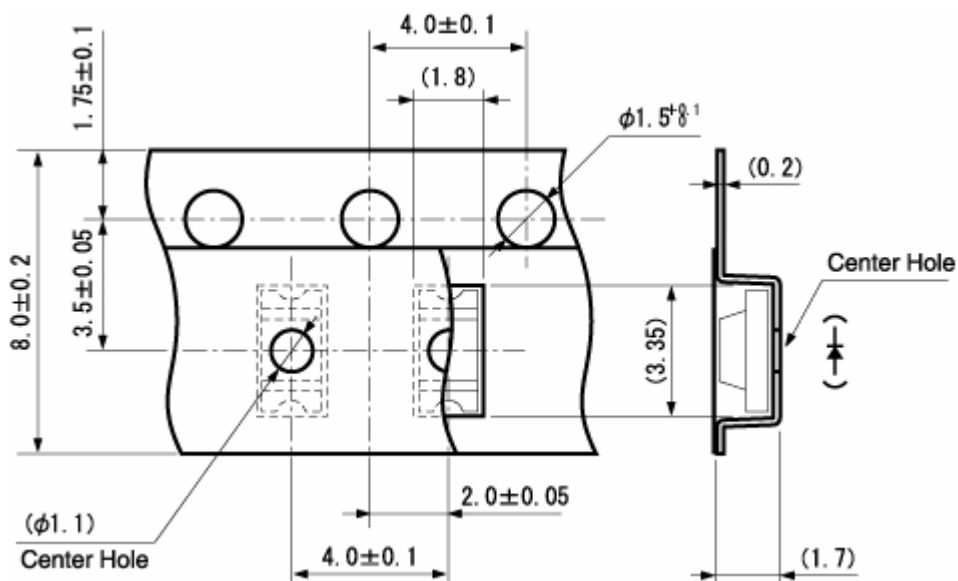

Reflow Soldering Conditions

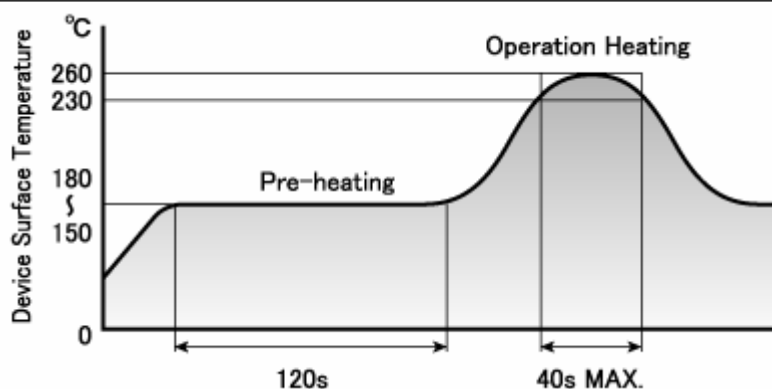

- 1) The above profile temperature gives the maximum temperature of the LED resin surface. Please set the temperature so as to avoid exceeding this range.
- 2) Total times of reflow soldering process shall be no more than 2 times. When the second reflow soldering process is performed, intervals between the first and second reflow should be short as possible (while allowing some time for the component to return to normal temperature after the first reflow) in order to prevent the LED from absorbing moisture.
- 3) Temperature fluctuation to the LED during the pre-heating process shall be minimized.

Manual Soldering Conditions

Iron tip temp.	350 °C	(MAX.) (30 W Max.)
Soldering time and frequency	3 s	(MAX.)
	1 time	(MAX.)

Reliability Testing Result

Reliability Testing Result	Applicable Standard	Testing Conditions	Duration	Failure
Room Temp. Operating Life	EIAJ ED-4701/100(101)	Ta = 25°C, If = Maximum Rated Current	1,000 h	0/25
Resistance to Soldering Heat	EIAJ ED-4701/300(301)	(Pretreatment) Individual standard (Reflow Soldering) Pre-heating 150°C~180°C 120s Operating Heating 230°C Min. Peak temperature 260°C	Twice	0/25
Temperature Cycling	EIAJ ED-4701/100(105)	Minimum Rated Storage Temperature(30min) ~Normal Temperature(15min) ~Maximum Rated Storage Temperature(30min) ~Normal Temperature(15min)	5 cycles	0/25
Wet High Temp. Storage Life	EIAJ ED-4701/100(103)	Ta = 60±2°C, RH = 90±5%	1,000 h	0/25
High Temp. Storage Life	EIAJ ED-4701/200(201)	Ta = Maximum Rated Storage Temperature	1,000 h	0/25
Low Temp. Storage Life	EIAJ ED-4701/200(202)	Ta = Minimum Rated Storage Temperature	1,000 h	0/25
Vibration, Variable Frequency	EIAJ ED-4701/400(403)	98.1m/s ² (10G), 100 ~ 2KHz sweep for 20min., XYZ each direction	2 h	0/10

Failure Criteria

Items	Symbols	Conditions	Failure criteria
Radiant Intensity	I _E	If Value of each product Radiant Intensity	Testing Min. Value < Initial Value x 0.5
Forward Voltage	V _F	If Value of each product Forward Voltage	Testing Max. Value > Spec. Max. Value x 1.2
Reverse Current	I _R	V _R = Maximum Rated Reverse Voltage V	Testing Max. Value ≥ Spec. Max. Value x 2.5
Cosmetic Appearance	-	-	Occurrence of notable decoloration, deformation and cracking

Special Notice to Customers Using the Products and Technical Information Shown in This Data Sheet

- 1) The technical information shown in the data sheets are limited to the typical characteristics and circuit examples of the referenced products. It does not constitute the warranting of industrial property nor the granting of any license.
- 2) For the purpose of product improvement, the specifications, characteristics and technical data described in the data sheets are subject to change without prior notice. Therefore it is recommended that the most updated specifications be used in your design.
- 3) When using the products described in the data sheets, please adhere to the maximum ratings for operating voltage, heat dissipation characteristics, and other precautions for use. We are not responsible for any damage which may occur if these specifications are exceeded.
- 4) The products that have been described to this catalog are manufactured so that they will be used for the electrical instrument of the benchmark (OA equipment, telecommunications equipment, AV machine, home appliance and measuring instrument).
The application of aircrafts, space borne application, transportation equipment, medical equipment and nuclear power control equipment, etc. needs a high reliability and safety, and the breakdown and the wrong operation might influence the life or the human body. Please consult us beforehand if you plan to use our product for the usages of aircrafts, space borne application, transportation equipment, medical equipment and nuclear power control equipment, etc. except OA equipment, telecommunications equipment, AV machine, home appliance and measuring instrument.
- 5) In order to export the products or technologies described in this data sheet which are under the "Foreign Exchange and Foreign Trade Control Law," it is necessary to first obtain an export permit from the Japanese government.
- 6) No part of this data sheet may be reprinted or reproduced without prior written permission from Stanley Electric Co., Ltd.
- 7) The most updated edition of this data sheet can be obtained from the address below:
<http://www.stanley-components.com>