

$V_{DSM}$	=	2800 V
$I_{TAVM}$	=	5490 A
$I_{TRMS}$	=	8625 A
$I_{TSM}$	=	75000 A
$V_{T0}$	=	0.86 V
$r_T$	=	0.070 mW

## Phase Control Thyristor

# 5STP 45Q2800

Doc. No. 5SYA1050-01 Sep.00

- Patented free-floating silicon technology
- Low on-state and switching losses
- Designed for traction, energy and industrial applications
- Optimum power handling capability
- Interdigitated amplifying gate.

### Blocking

Part Number	5STP 45Q2800	5STP 45Q2600	5STP 45Q2200	Conditions
$V_{DRM}$ $V_{RRM}$	2800 V	2600 V	2200 V	$f = 50$ Hz, $t_p = 10$ ms
$V_{RSM1}$	3000 V	2800 V	2400 V	$t_p = 5$ ms, single pulse
$I_{DRM}$	$\leq 400$ mA			$T_j = 125^\circ\text{C}$
$I_{RRM}$	$\leq 400$ mA			
$dV/dt_{crit}$	1000 V/ $\mu$ s @ Exp. to $0.67 \times V_{DRM}$			

### Mechanical data

$F_M$	Mounting force	nom.	90 kN
		min.	81 kN
		max.	108 kN
a	Acceleration		
	Device unclamped		50 m/s <sup>2</sup>
	Device clamped		100 m/s <sup>2</sup>
m	Weight		2.1 kg
$D_S$	Surface creepage distance		36 mm
$D_a$	Air strike distance		15 mm



ABB Semiconductors AG reserves the right to change specifications without notice.

**ABB**

**On-state**

$I_{TAVM}$	Max. average on-state current	5490 A	Half sine wave, $T_C = 70^\circ\text{C}$	
$I_{TRMS}$	Max. RMS on-state current	8625 A		
$I_{TSM}$	Max. peak non-repetitive surge current	75000 A	$t_p = 10 \text{ ms}$	$T_j = 125^\circ\text{C}$ After surge: $V_D = V_R = 0\text{V}$
		79000 A	$t_p = 8.3 \text{ ms}$	
$I^2t$	Limiting load integral	28125 $\text{kA}^2\text{s}$	$t_p = 10 \text{ ms}$	
		25900 $\text{kA}^2\text{s}$	$t_p = 8.3 \text{ ms}$	
$V_T$	On-state voltage	1.29 V	$I_T = 6000 \text{ A}$	$T_j = 125^\circ\text{C}$
$V_{T0}$	Threshold voltage	0.86 V	$I_T = 3000 - 9000 \text{ A}$	
$r_T$	Slope resistance	0.070 $\text{m}\Omega$		
$I_H$	Holding current	40-100 mA	$T_j = 25^\circ\text{C}$	
		20-75 mA	$T_j = 125^\circ\text{C}$	
$I_L$	Latching current	100-500 mA	$T_j = 25^\circ\text{C}$	
		150-350 mA	$T_j = 125^\circ\text{C}$	

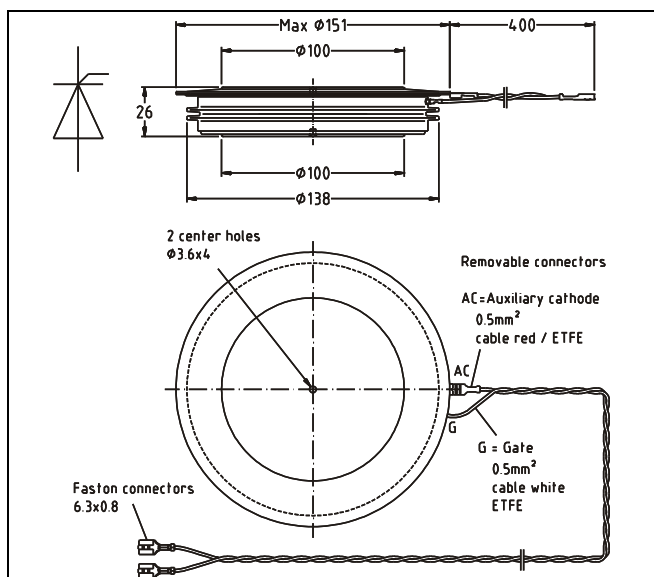
**Switching**

$di/dt_{crit}$	Critical rate of rise of on-state current	250 $\text{A}/\mu\text{s}$	Cont.	$V_D \leq 0.67 \cdot V_{DRM}$ $T_j = 125^\circ\text{C}$ $I_{TRM} = 3000 \text{ A}$ $f = 50 \text{ Hz}$ $I_{FG} = 2.0 \text{ A}$ $t_r = 0.5 \mu\text{s}$
		500 $\text{A}/\mu\text{s}$	60 sec.	
$t_d$	Delay time	$\leq 3.0 \mu\text{s}$	$V_D = 0.4 \cdot V_{DRM}$	$I_{FG} = 2.0 \text{ A}$ $t_r = 0.5 \mu\text{s}$
$t_q$	Turn-off time	$\leq 400 \mu\text{s}$	$V_D \leq 0.67 \cdot V_{DRM}$ $dv_D/dt = 20\text{V}/\mu\text{s}$	$I_{TRM} = 3000 \text{ A}$ $T_j = 125^\circ\text{C}$ $V_R > 200 \text{ V}$
$Q_{rr}$	Recovery charge	min	4200 $\mu\text{As}$	$di_T/dt = -5 \text{ A}/\mu\text{s}$
		max	6500 $\mu\text{As}$	

**Triggering**

$V_{GT}$	Gate trigger voltage	2.6 V	$T_j = 25^\circ\text{C}$
$I_{GT}$	Gate trigger current	400 mA	$T_j = 25^\circ\text{C}$
$V_{GD}$	Gate non-trigger voltage	0.3 V	$V_D = 0.4 \cdot V_{DRM}$
$I_{GD}$	Gate non-trigger current	10 mA	$V_D = 0.4 \cdot V_{DRM}$
$V_{FGM}$	Peak forward gate voltage	12 V	
$I_{FGM}$	Peak forward gate current	10 A	
$V_{RGM}$	Peak reverse gate voltage	10 V	
$P_G$	Maximum gate power loss	3 W	

### Thermal

$T_{j\ max}$	Max. junction temperature	125°C	
$T_{j\ stg}$	Storage temperature range	-40...150°C	
$R_{thJC}$	Thermal resistance junction to case	10 K/kW	Anode side cooled
		10 K/kW	Cathode side cooled
		5 K/kW	Double side cooled
$R_{thCH}$	Thermal resistance case to heat sink	2 K/kW	Single side cooled
		1 K/kW	Double side cooled

Analytical function for transient thermal impedance:

$$Z_{thJC}(t) = \sum_{i=1}^n R_i(1 - e^{-t/t_i})$$

i	1	2	3	4
$R_i$ (K/kW)	3.27	0.736	0.661	0.312
$\tau_i$ (s)	0.5237	0.1082	0.02	0.0075

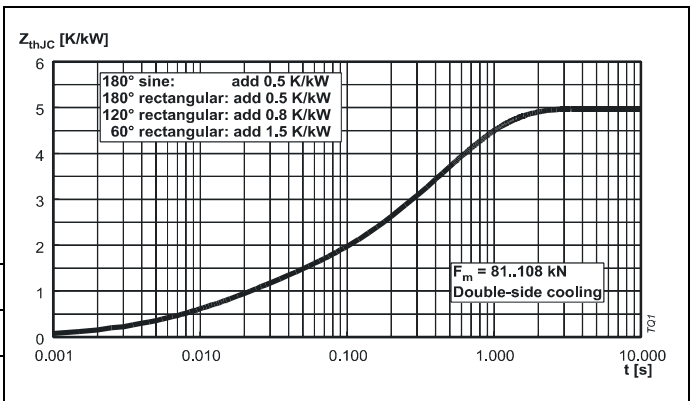

Fig. 1 Transient thermal impedance junction to case.

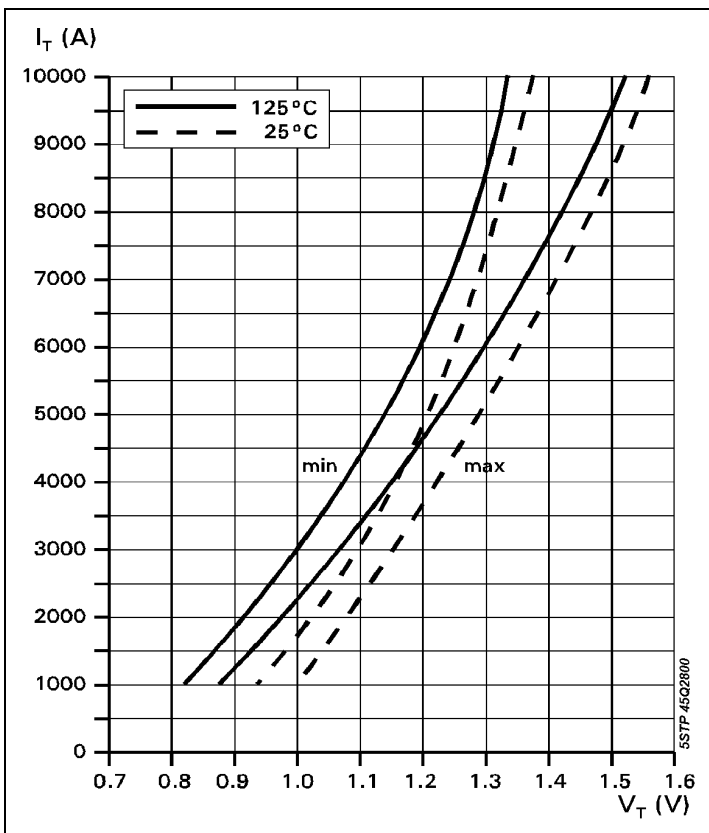

Fig. 2. On-state characteristics.

On-state characteristic model:

$$V_T = A + B \cdot i_T + C \cdot \ln(i_T + 1) + D \cdot \sqrt{i_T}$$

Valid for  $i_T = 500 - 15000$  A

A	B	C	D
-0.096289	0.000051	0.135731	-0.001358

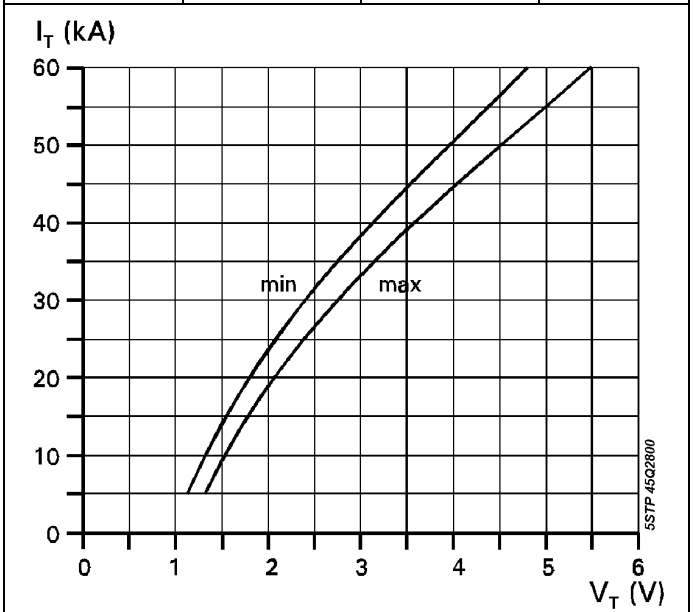
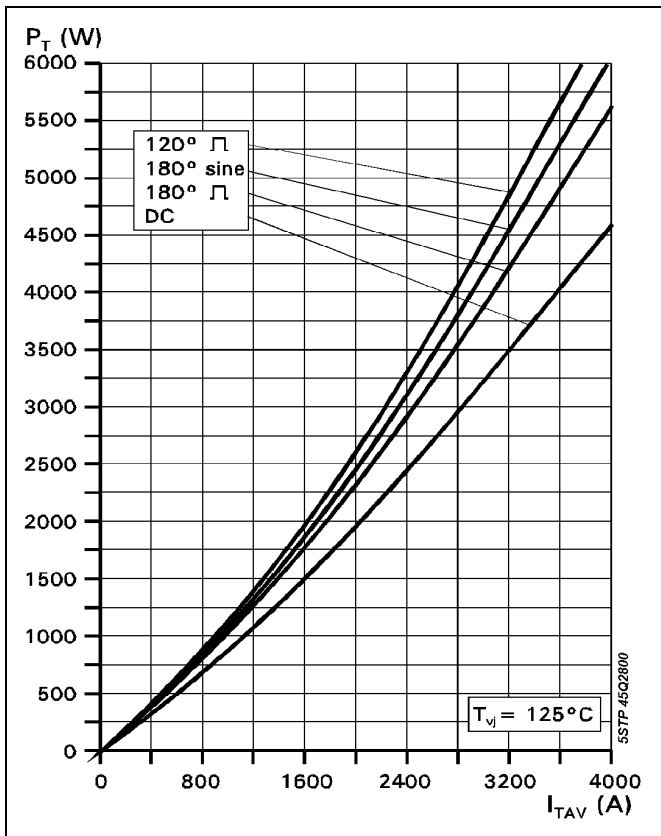
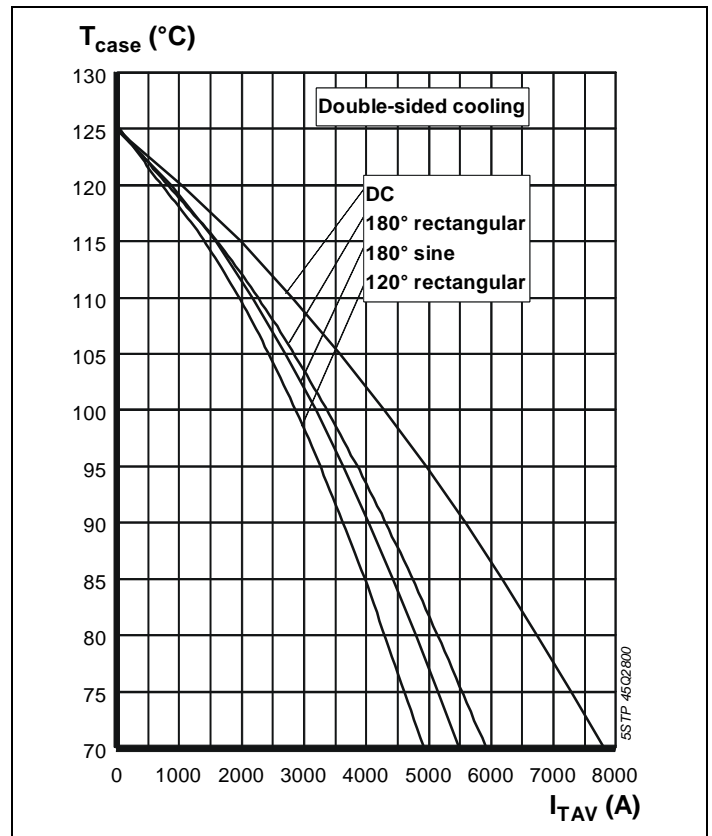

Fig. 3 On state characteristics.



**Fig. 4** On-state power dissipation vs. mean on-state current. Turn-on losses excluded.



**Fig. 5** Max. permissible case temperature vs. mean on-state current.

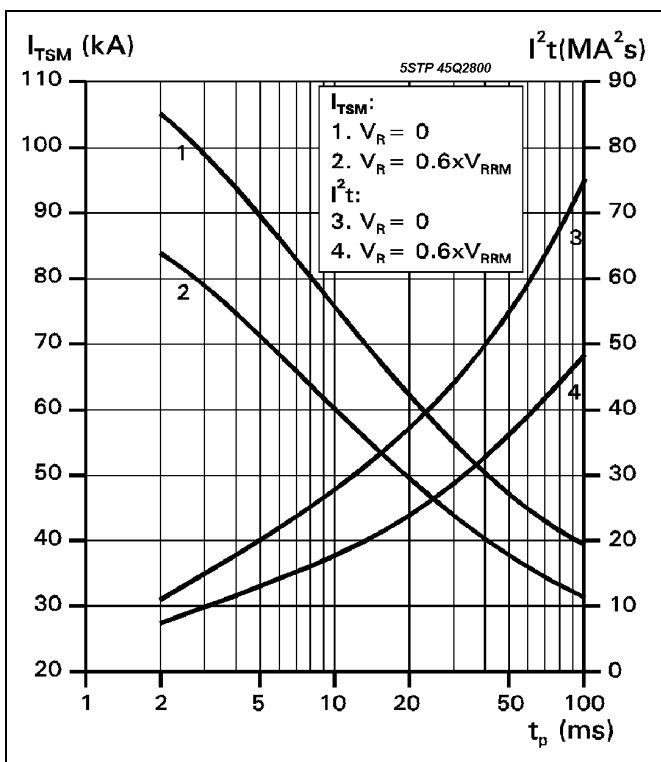

**Fig. 6** Surge on-state current vs. pulse length. Half-sine wave.

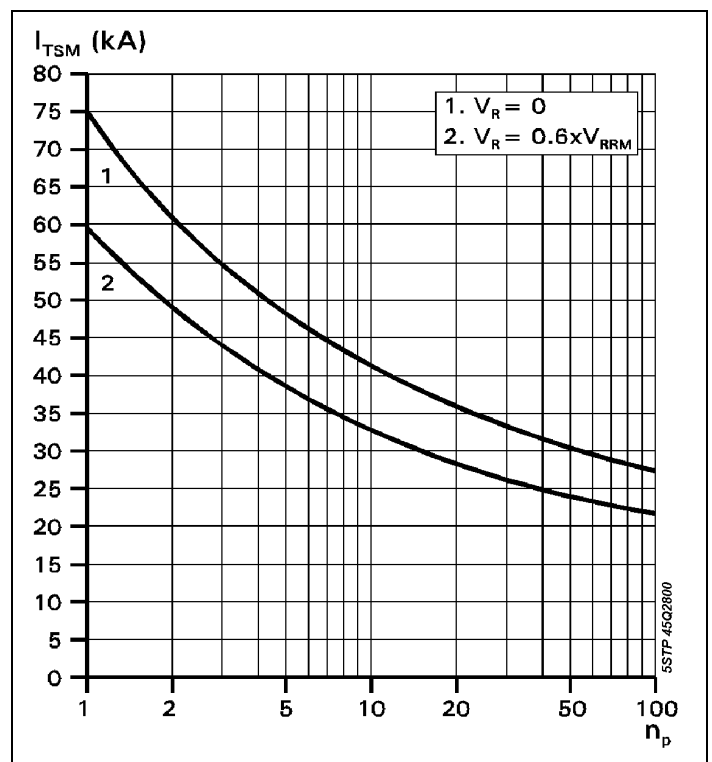

**Fig. 7** Surge on-state current vs. number of pulses. Half-sine wave, 10 ms, 50Hz.

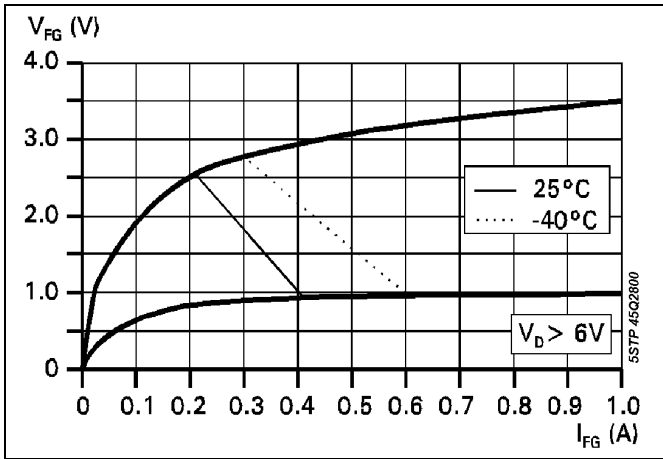

Fig. 8 Gate trigger characteristics.

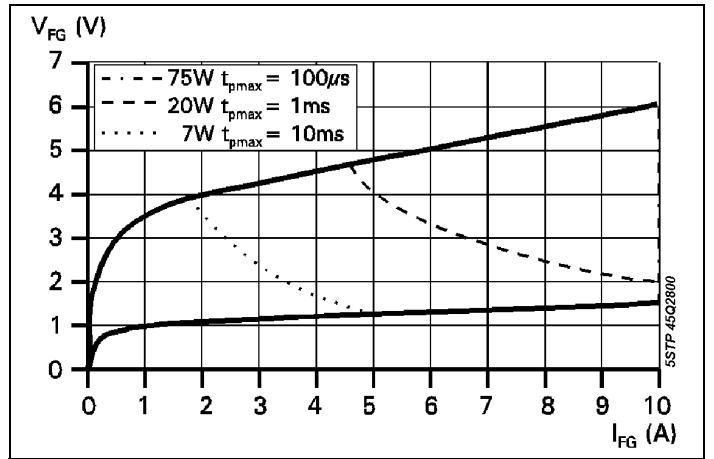

Fig. 9 Max. peak gate power loss.

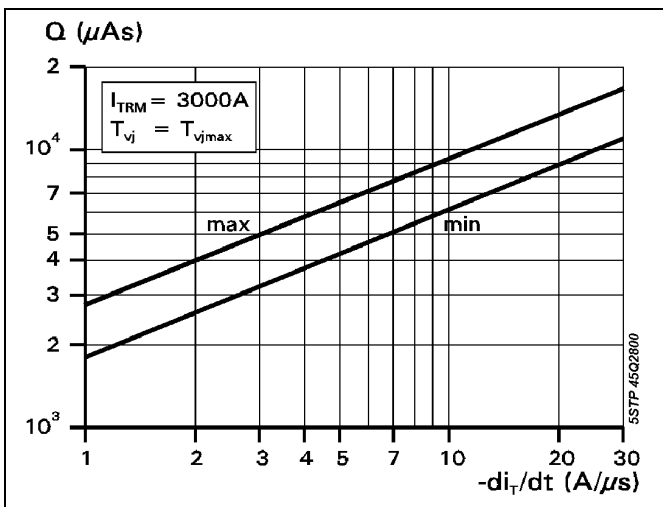

Fig. 10 Recovery charge vs. decay rate of on-state current.

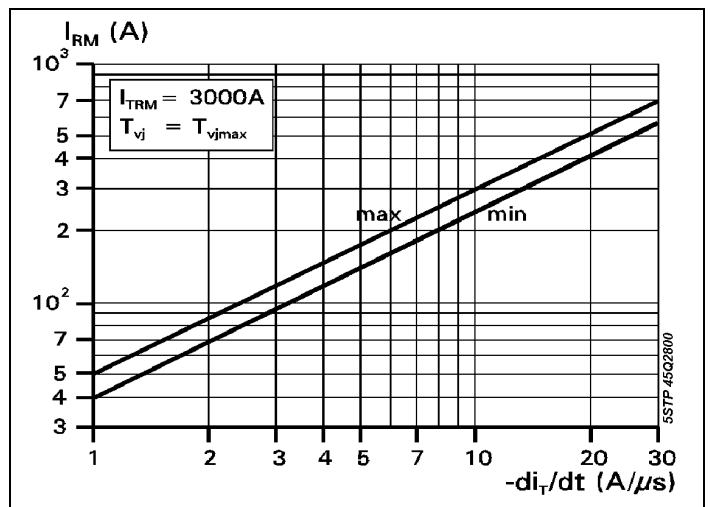

Fig. 11 Peak reverse recovery current vs. decay rate of on-state current.

**Turn –off time, typical parameter relationship.**

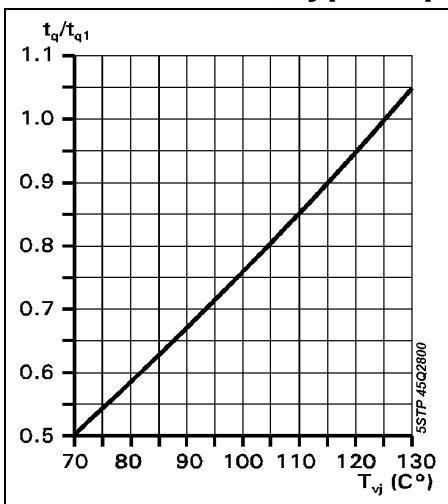

Fig. 12  $t_q/t_{q1} = f_1(T_j)$

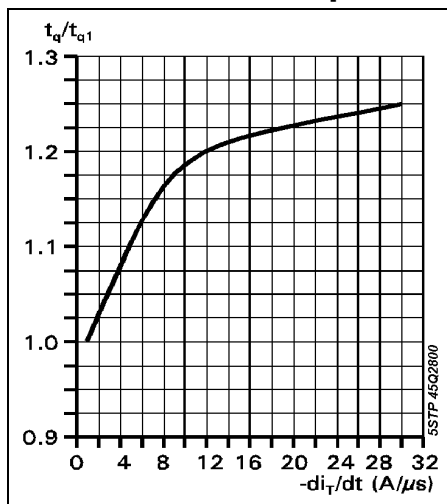

Fig. 13  $t_q/t_{q1} = f_2(-di/dt)$

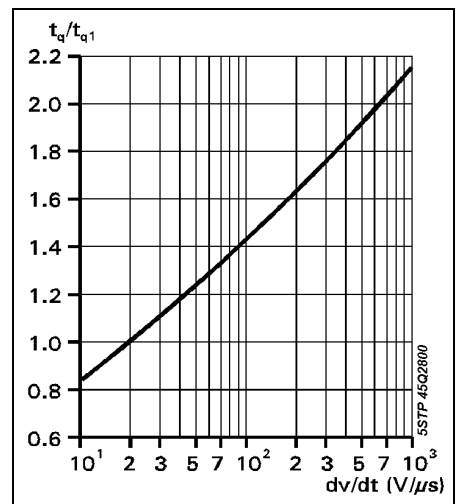
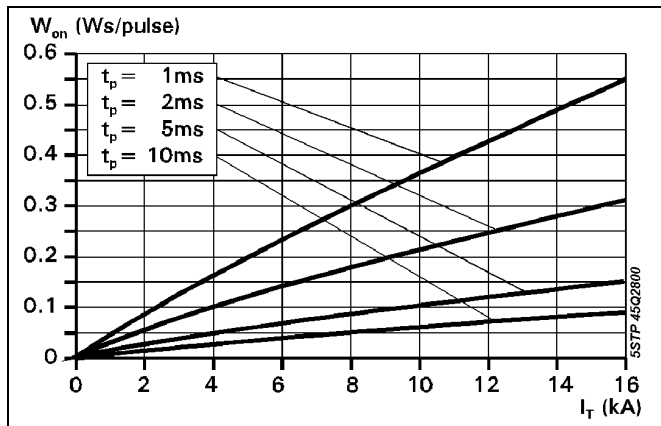

Fig. 14  $t_q/t_{q1} = f_3(dv/dt)$

$t_q = t_{q1} \cdot t_q/t_{q1} f_1(T_j) \cdot t_q/t_{q1} f_2(-di/dt) \cdot t_q/t_{q1} f_3(dv/dt)$   $t_{q1}$  : at normalized values (see page 2)  
 $t_q$  : at varying conditions

### Turn-on and Turn-off losses



**Fig. 15**  $W_{on} = f(I_T, t_p)$ ,  $T_j = 125^\circ C$ .  
Half sinusoidal waves.

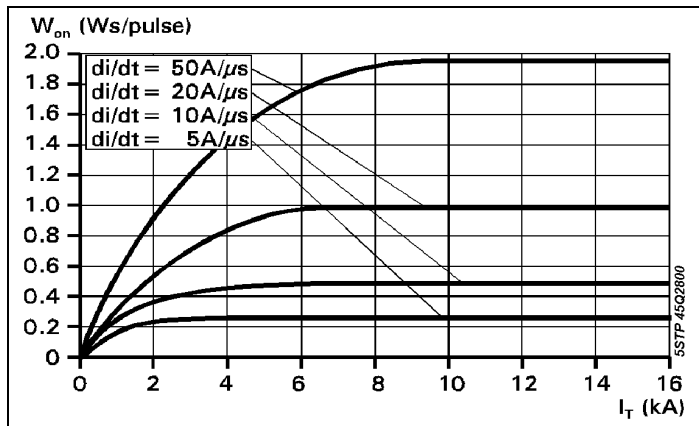

**Fig. 16**  $W_{on} = f(I_T, di/dt)$ ,  $T_j = 125^\circ C$ .  
Rectangular waves.

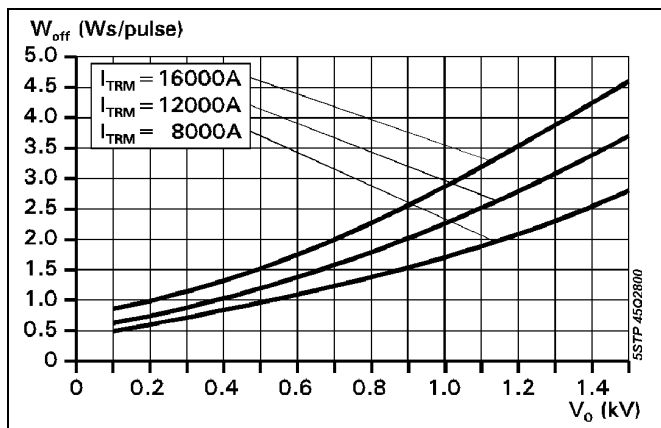

**Fig. 17**  $W_{off} = f(V_o, I_T)$ ,  $T_j = 125^\circ C$ .  
Half sinusoidal waves.  $t_p = 10$  ms.

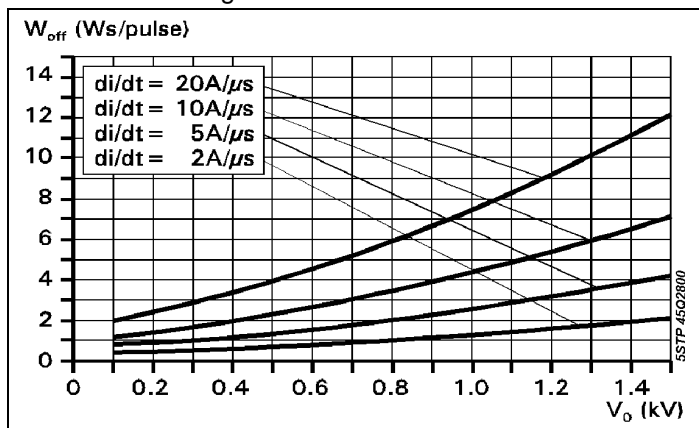

**Fig. 18**  $W_{off} = f(V_o, di/dt)$ ,  $T_j = 125^\circ C$ .  
Rectangular waves.

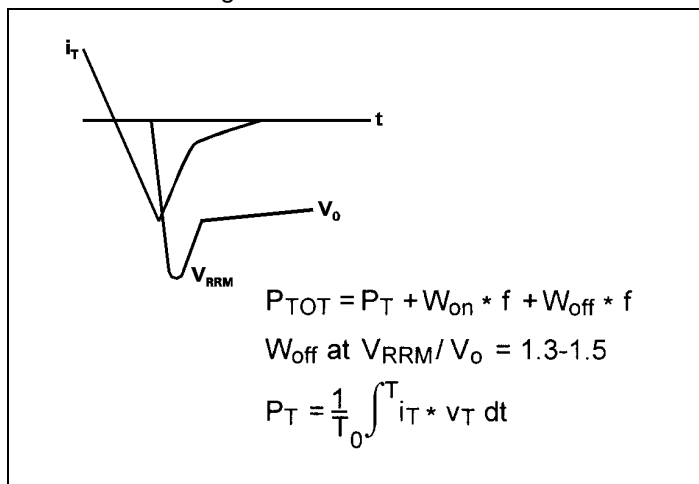

ABB Semiconductors reserves the right to change specifications without notice.



**ABB Semiconductors AG**  
Fabrikstrasse 3  
CH-5600 Lenzburg, Switzerland

Telephone +41 (0)62 888 6419  
Fax +41 (0)62 888 6306  
Email [Info@ch.abb.com](mailto:Info@ch.abb.com)  
Internet [www.abbsem.com](http://www.abbsem.com)