

Surface mount switching diode **BAV19W/ BAV20W/ BAV21W**

FEATURES

- Fast Switching Speed.
- Surface Mount Package Ideally Suited For Automatic Insertion
- For General Purpose Switching Applications.



Lead-free

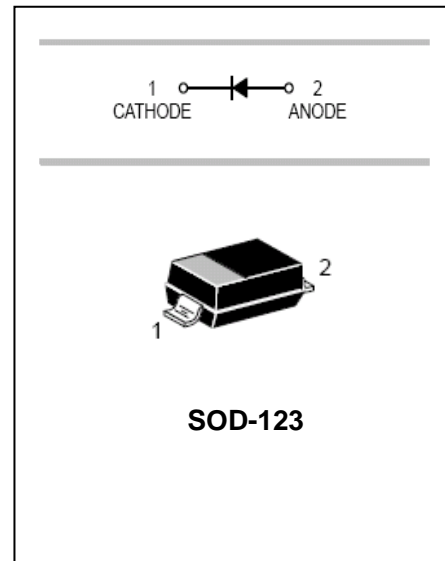

APPLICATIONS

- Surface mount fast switching diode

ORDERING INFORMATION

Type No.	Marking	Package Code
BAV19W	A8	SOD-123
BAV20W	T2	SOD-123
BAV21W	T3	SOD-123

MAXIMUM RATING @ Ta=25°C unless otherwise specified

Characteristic	Symbol	BAV19W	BAV20W	BAV21W	Unit
Non-Repetitive Peak Reverse Voltage	V_{RM}	120	200	250	V
Peak Repetitive Reverse Voltage	V_{RRM}				
Working Peak Reverse Voltage	V_{RWM}	100	150	200	V
DC Reverse Voltage	V_R				
RMS Reverse Voltage	$V_{R(RMS)}$	71	106	141	V
Forward Continuous Current	I_{FM}	400			mA
Average Rectified Output Current	I_o	200			mA
Non-Repetitive Peak Forward Surge Current	I_{FSM}				A
@t=1.0 μ s					
@t=1.0 s	0.5				
Repetitive Peak Forward Surge Current	I_{FRM}	625			mA
Power Dissipation	P_d	250			mW
Thermal Resistance Junction to Ambient Air	$R_{\theta JA}$	500			$^{\circ}C/W$
Operating and Storage Temperature Range	T_j, T_{STG}	-65 to +150			$^{\circ}C$

Surface mount switching diode **BAV19W/ BAV20W/ BAV21W**

ELECTRICAL CHARACTERISTICS @ Ta=25°C unless otherwise specified

Characteristic	Symbol	Min	Max	Unit	Test Condition
Maximum Forward Voltage	V_{F1} V_{F2}	-	1.0 1.25	V	$I_F=100mA$ $I_F=200mA$
Reverse Current	BAV19W BAV20W BAV21W I_R	-	0.1	μA	$V_R=100V$ $V_R=150V$ $V_R=200V$
Junction Capacitance	C_j	-	5.0	pF	$V_R=0, f=1.0MHz$
Reverse Recovery Time	t_{rr}	-	50	ns	$I_F=I_R=30mA,$ $I_{rr}=0.1 \times I_R, R_L=100\Omega$

TYPICAL CHARACTERISTICS @ Ta=25°C unless otherwise specified

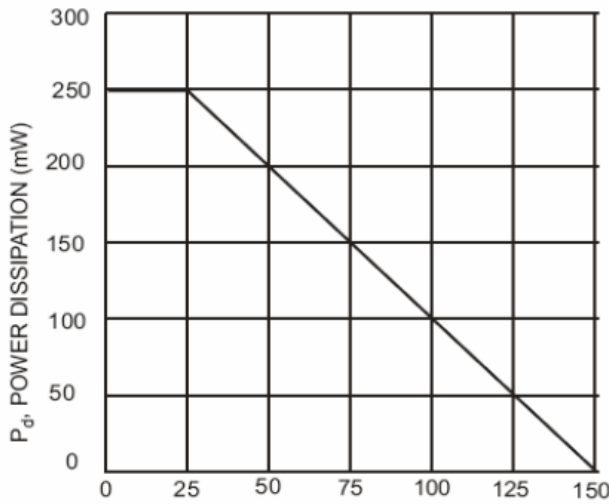

Fig. 1 Power Derating Curve

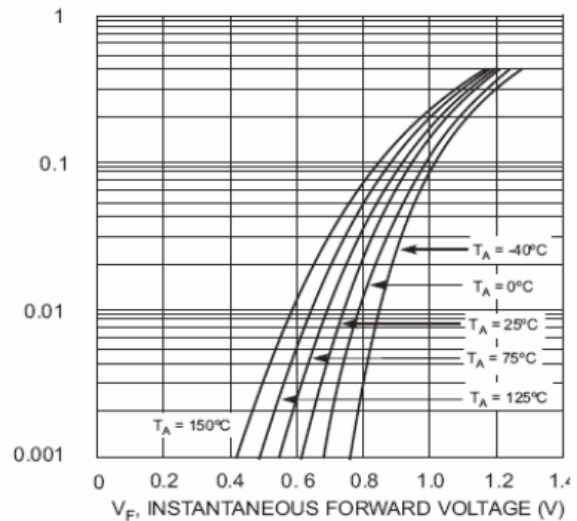

Fig. 2 Typical Forward Characteristics

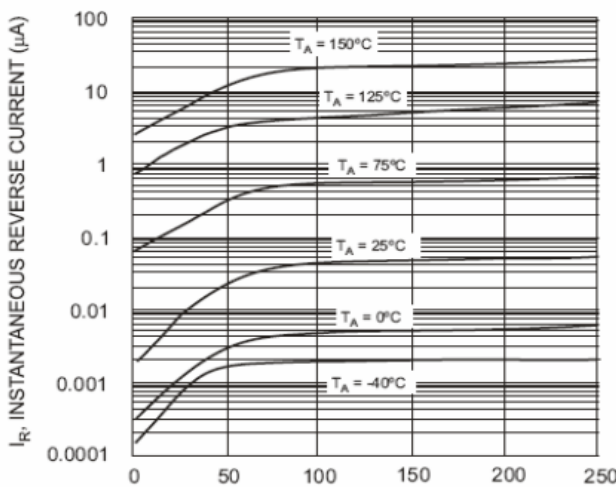

Fig. 3 Typical Reverse Characteristics

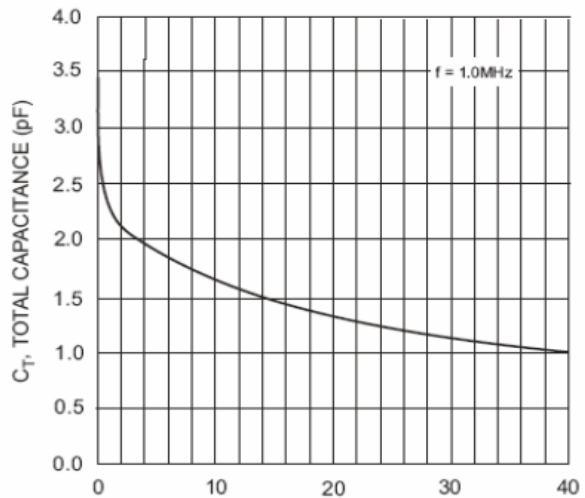

Fig. 4 Typical Capacitance vs. Reverse Voltage

Surface mount switching diode **BAV19W/ BAV20W/ BAV21W**

PACKAGE OUTLINE

Plastic surface mounted package

SOD-123

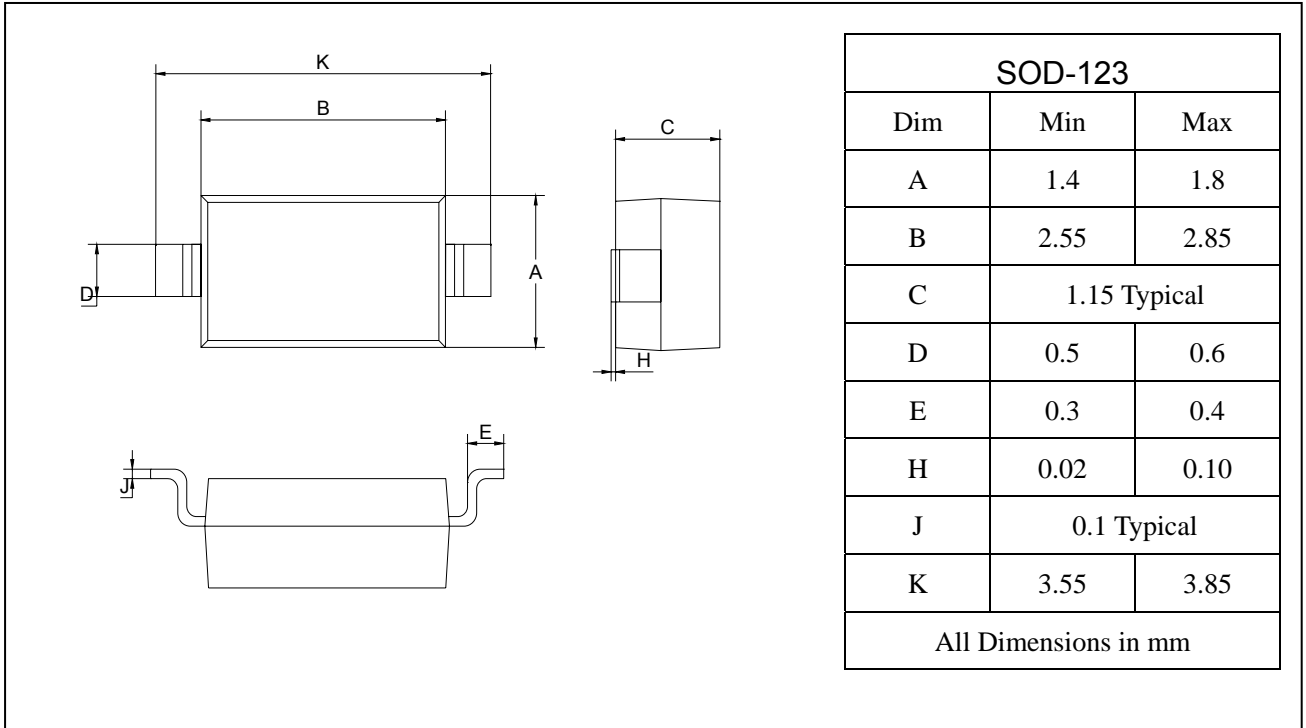

SOLDERING FOOTPRINT

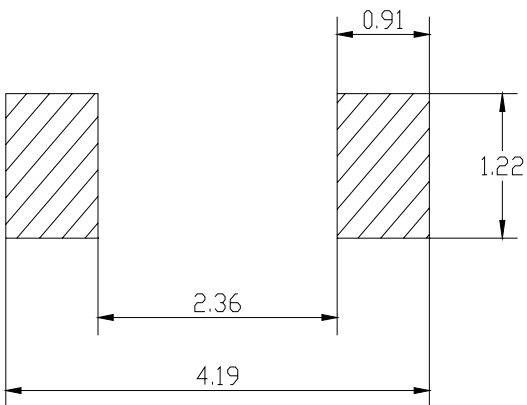

Unit : mm

PACKAGE INFORMATION

Device	Package	Shipping
BAV19W/20W/21W	SOD-123	3000/Tape&Reel