

AlGaInP Visible Laser Diode

ADL-66201TL

DATE:2007/12/17 Ver 2.0

★660nm 20mW 60°C

Reliable High Power Operation

•Features

1. Low operating current
2. High efficiency
3. High precision package
4. High power operation

•Applications

1. Laser pointers
2. Industrial laser markers / measuring instruments
3. High visibility applications

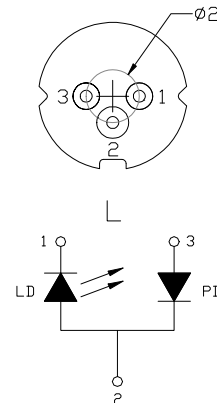
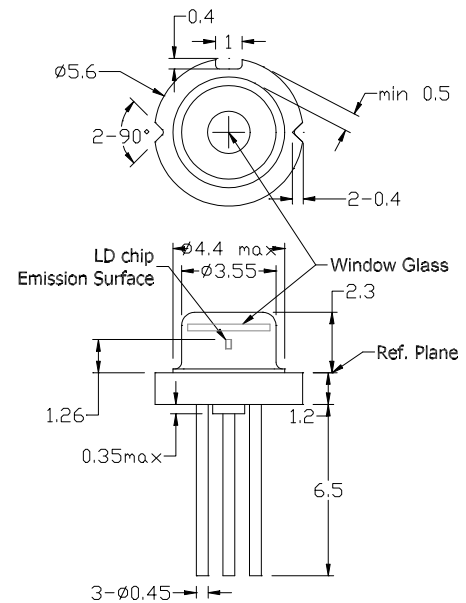

•Absolute maximum ratings

Parameter	Symbol	Condition	Rating	Unit
Light output power	P_O	CW	22	mW
Reverse voltage (LD)	V_{RL}	-	2	V
Reverse voltage (PD)	V_{RD}	-	30	V
Forward current (PD)	I_{FD}	-	10	mA
Case temperature	T_C	-	-10~+60	°C
Storage temperature	T_S	-	-40~+85	°C

•Electrical and optical characteristics ($T_c=25^\circ\text{C}$)

Parameter	Symbol	Min.	Typ.	Max.	Unit	Conditions
Peak wavelength	λ	650	658	665	nm	$P_o=20\text{mW}$
Threshold current	I_{th}		42	50	mA	
Operating current	I_{op}		70	80	mA	$P_o=20\text{mW}$
Operating voltage	V_{op}	2.0	2.3	2.6	V	$P_o=20\text{mW}$
Differential efficiency	η	0.5	0.8	1.0	mW/mA	$P_o=15\sim 20\text{mW}$
Monitor current	I_m	0.05	0.15	0.5	mA	$P_o=20\text{mW}, V_{RD}=0\text{V}$
Parallel divergence angle	$\theta_{ }$	6	8	10	deg	
Perpendicular divergence angle	θ_{\perp}	14	18	22	deg	
Parallel FFP deviation angle	$\Delta\theta_{ }$	-2	0	+2	deg	$P_o=20\text{mW}$
Perpendicular FFP deviation angle	$\Delta\theta_{\perp}$	-2	0	+2	deg	
Emission point accuracy	$\Delta x\Delta y\Delta z$	-80	0	+80	um	

•Precautions

- * Do not operate the device above maximum ratings. Doing so may cause unexpected and permanent damage to the device.
- * Take precautions to avoid electrostatic discharge and/or momentary power spikes. A change in the characteristics of the laser or premature failure may result.
- * Proper heat sinking of the device assures stability and lifetime. Always ensure that maximum operating temperatures are not exceeded.
- * Observing visible or invisible laser beams with the human eye directly, or indirectly, can cause permanent damage. Use a camera to observe the laser.
- * No laser device should be used in any application or situation where life or property is at risk in event of device failure.
- * Specifications are subject to change without notice. Ensure that you have the latest specification by contacting us prior to purchase or use of the product.



* For reference only. Contents above are subject to change without notice.

AlGaInP Visible Laser Diode

ADL-66201TL

DATE:2007/12/17 Ver 2.0

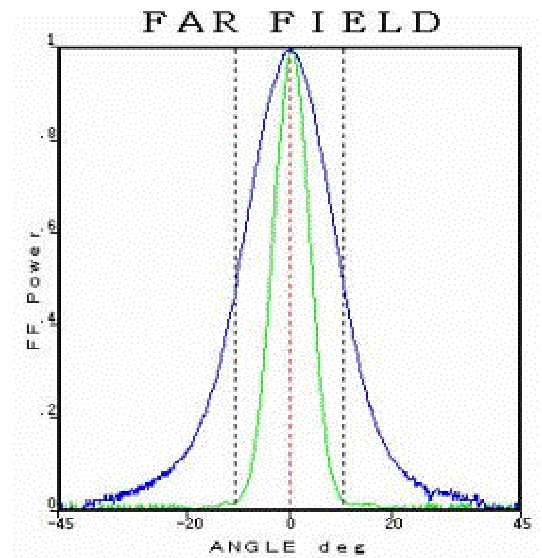
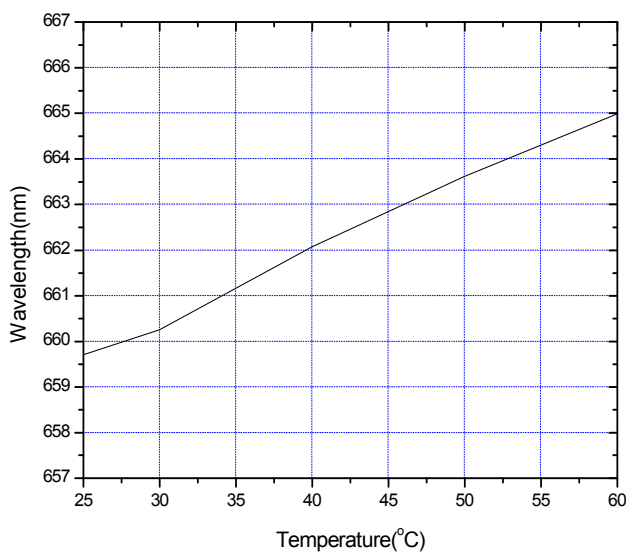
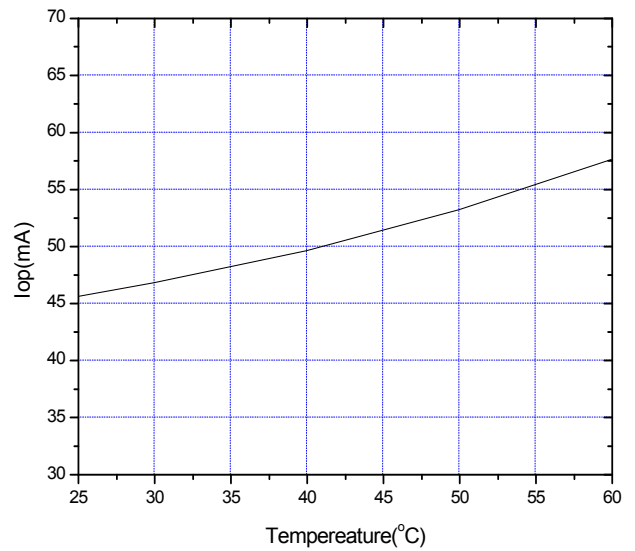
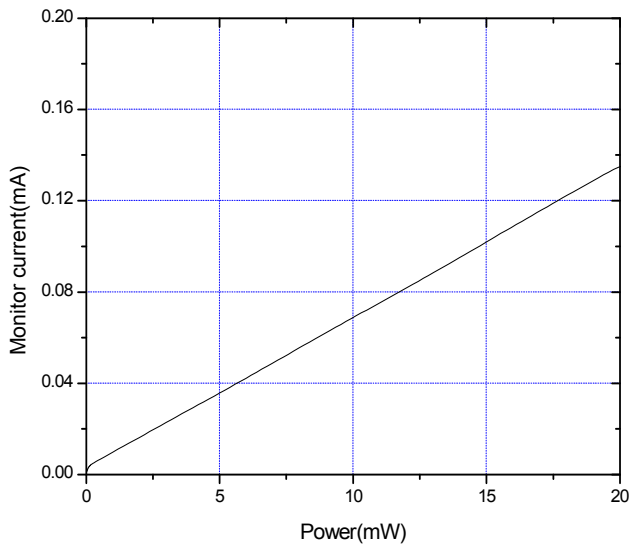
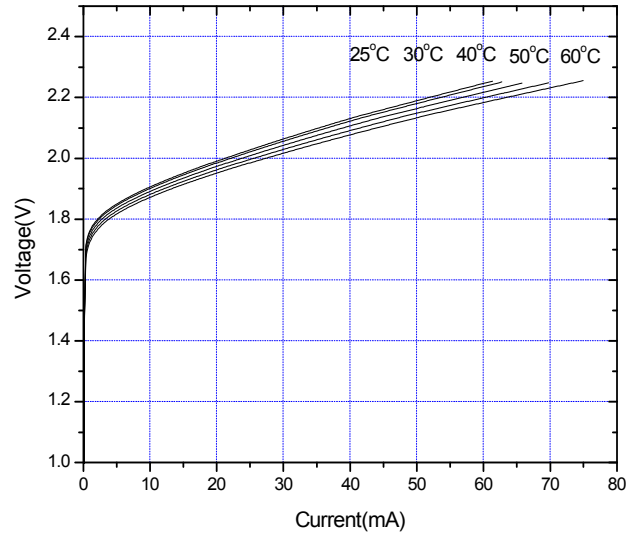
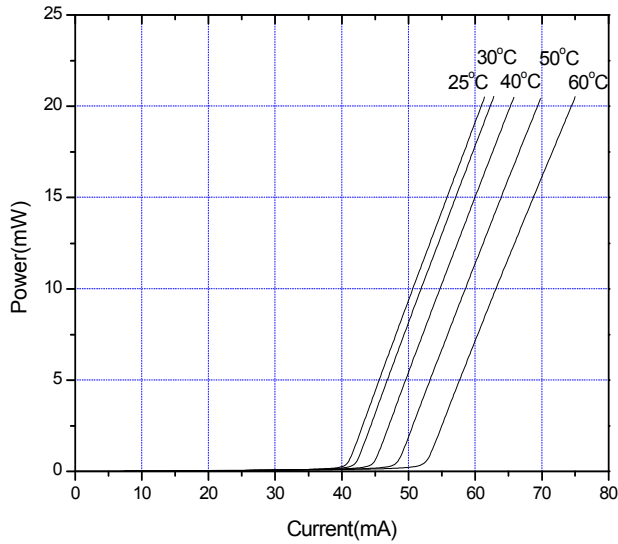

* For reference only. Contents above are subject to change without notice.

Arima
LASERS

www.lasercomponents.com

01/08 / V2 / HW / divers-vis/ari/655nm/ adl66201tl.pdf

Germany and other countries: LASER COMPONENTS GmbH, Phone: +49 8142 2864 0, Fax: +49 8142 2864 11, info@lasercomponents.com

USA: LASER COMPONENTS IG, Inc., Phone: +1 603 821 7040, Fax: +1 603 821 7041, info@laser-components.com

Great Britain: LASER COMPONENTS (UK) Ltd., Phone: +44 1245 491 499, Fax: +44 1245 491 801, info@lasercomponents.co.uk

France: LASER COMPONENTS S.A.S., Phone: +33 1 3959 5225, Fax: +33 1 3959 5350, info@lasercomponents.fr