

SEMiX 302GB066HD

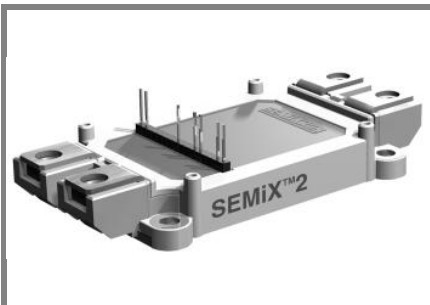

SEMiX[®] 2

Trench IGBT Modules

SEMiX 302GB066HD

Target Data

Features

- Homogeneous Si
- Trench = Trenchgate technology
- $V_{CE(sat)}$ with positive temperature coefficient

Typical Applications

- Matrix Converter
- Resonant Inverter
- Current Source Inverter

Remarks

- Case temperature limited to $T_C=125^\circ\text{C}$ max
- Product reliability results are valid for $T_j=150^\circ\text{C}$
- SC data: $t_p \leq 6 \mu\text{s}$; $V_{GE} \leq 15 \text{ V}$; $T_j = 150^\circ\text{C}$; $V_{CC} = 360 \text{ V}$

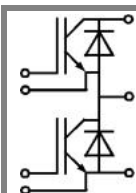

GB

Absolute Maximum Ratings		$T_{case} = 25^\circ\text{C}$, unless otherwise specified	
Symbol	Conditions	Values	Units
IGBT			
V_{CES}		600	V
I_C	$T_c = 25 (80)^\circ\text{C}$, $T_j = 150^\circ\text{C}$	360 (250)	A
I_C	$T_c = 25 (80)^\circ\text{C}$, $T_j = 175^\circ\text{C}$	390 (300)	A
I_{CRM}	$t_p = 1 \text{ ms}$	600	A
V_{GES}		± 20	V
$T_j, (T_{stg})$		-40 ... +175 (125)	$^\circ\text{C}$
V_{isol}	AC, 1 min.	4000	V
Inverse diode			
I_F	$T_c = 25 (80)^\circ\text{C}$, $T_j = 150^\circ\text{C}$	300 (200)	A
I_F	$T_c = 25 (80)^\circ\text{C}$, $T_j = 175^\circ\text{C}$	330 (240)	A
I_{FRM}	$t_p = 1 \text{ ms}$	600	A
I_{FSM}	$t_p = 10 \text{ ms}$; sin.; $T_j = 25^\circ\text{C}$	1400	A

Characteristics		$T_{case} = 25^\circ\text{C}$, unless otherwise specified			
Symbol	Conditions	min.	typ.	max.	Units
IGBT					
$V_{GE(th)}$	$V_{GE} = V_{CE}$, $I_C = 3 \text{ mA}$		5,8		V
I_{CES}	$V_{CE} = 0$, $V_{GE} = V_{CES}$, $T_j = 25 (150)^\circ\text{C}$			0,1	mA
$V_{CE(TO)}$	$T_j = 25 (150)^\circ\text{C}$		0,9 (0,85)	1 (0,9)	V
r_{CE}	$V_{GE} = 15 \text{ V}$, $T_j = 25 (150)^\circ\text{C}$		1,8 (2,8)	3 (4)	m Ω
$V_{CE(sat)}$	$I_{Cnom} = 300 \text{ A}$, $V_{GE} = 15 \text{ V}$, $T_j = 25 (150)^\circ\text{C}$, chip level		1,45 (1,7)	1,9 (2,1)	V
C_{ies}	under following conditions		18,5		nF
C_{oes}	$V_{GE} = 0$, $V_{CE} = 25 \text{ V}$, $f = 1 \text{ MHz}$		1,2		nF
C_{res}			0,55		nF
L_{CE}			18		nH
R_{CC+EE}	terminal-chip, $T_c = 25 (150)^\circ\text{C}$		0,7 (1)		m Ω
$t_{d(on)}/t_r$	$V_{CC} = 300 \text{ V}$, $I_{Cnom} = 300 \text{ A}$		110 / 80		ns
$t_{d(off)}/t_f$	$V_{GE} = -8/+15 \text{ V}$		632 / 70		ns
$E_{on} (E_{off})$	$R_{Gon} = R_{Goff} = 8 \Omega$, $T_j = 150^\circ\text{C}$		9 (12)		mJ
Inverse Diode					
$V_F = V_{EC}$	$I_{Fnom} = 300 \text{ A}$; $V_{GE} = 0 \text{ V}$; $T_j = 25 (150)^\circ\text{C}$, chip level		1,4 (1,4)	1,6	V
$V_{(TO)}$	$T_j = 25 (150)^\circ\text{C}$		1 (0,85)	1,1	V
r_T	$T_j = 25 (150)^\circ\text{C}$		1,3 (1,8)	1,7	m Ω
I_{RRM}	$I_{Fnom} = 300 \text{ A}$; $T_j = 25 (150)^\circ\text{C}$		(270)		A
Q_{rr}	$di/dt = \text{A}/\mu\text{s}$		(38)		μC
E_{rr}	$V_{GE} = -8 \text{ V}$		(8,5)		mJ
Thermal characteristics					
$R_{th(j-c)}$	per IGBT			0,15	K/W
$R_{th(j-c)D}$	per Inverse Diode			0,25	K/W
$R_{th(j-c)FD}$	per FWD				K/W
$R_{th(c-s)}$	per module		0,045		K/W
Temperature sensor					
R_{25}	$T_c = 25^\circ\text{C}$		5 \pm 5%		k Ω
$B_{25/85}$	$R_2 = R_1 \exp[B(1/T_2 - 1/T_1)]$; $T[K]$; B		3420		K
Mechanical data					
M_s/M_t	to heatsink (M5) / for terminals (M6)	3/2,5		5 / 5	Nm
w			250		g

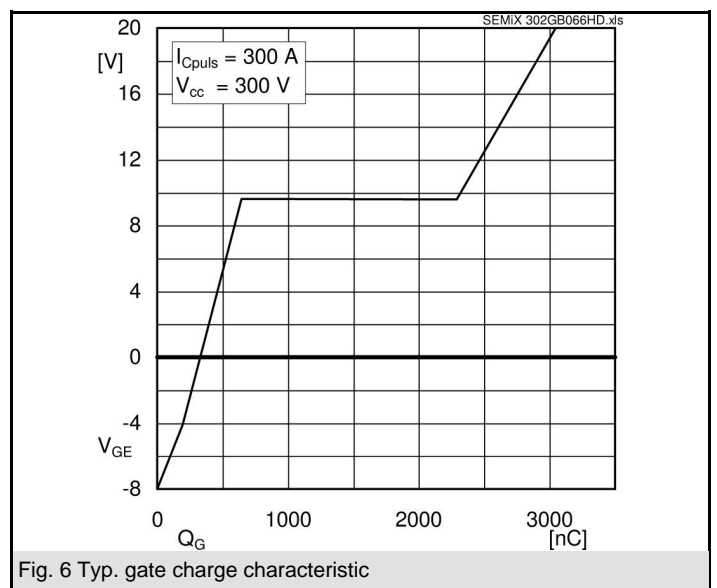
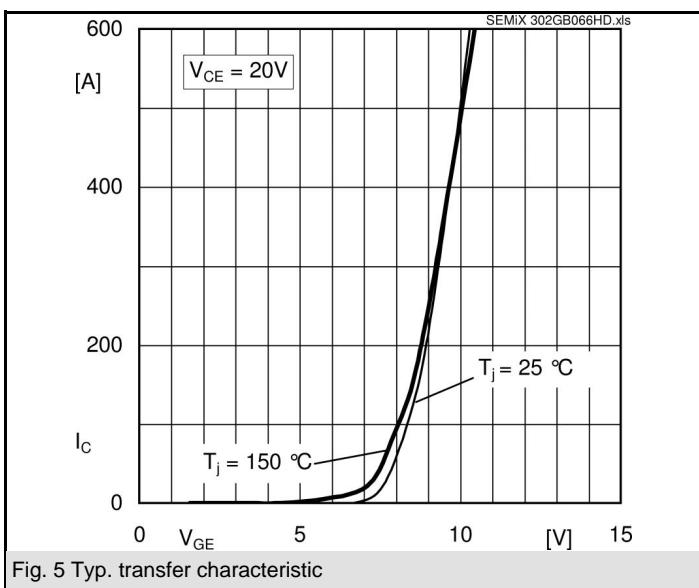
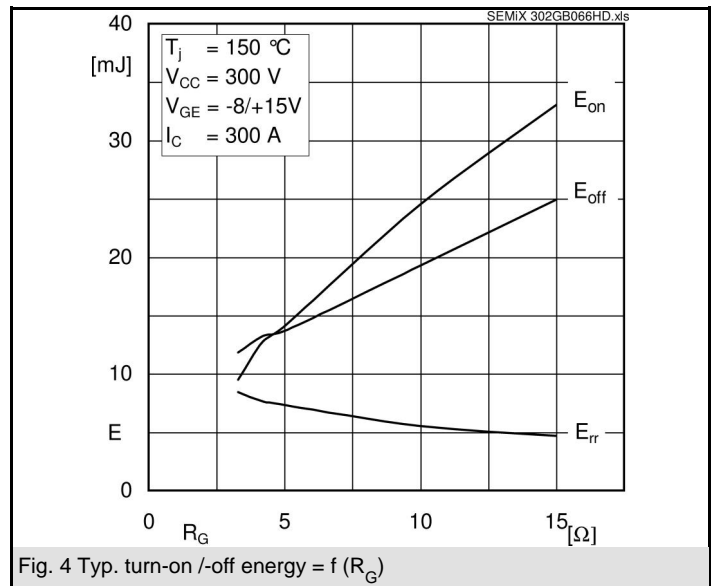
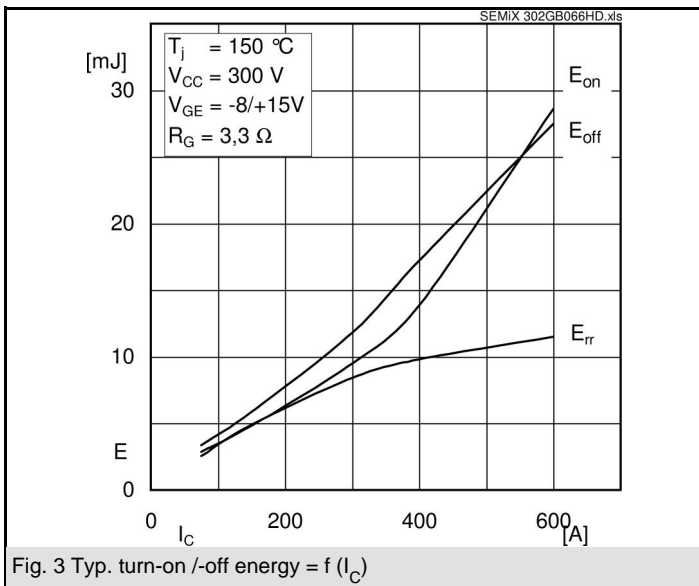
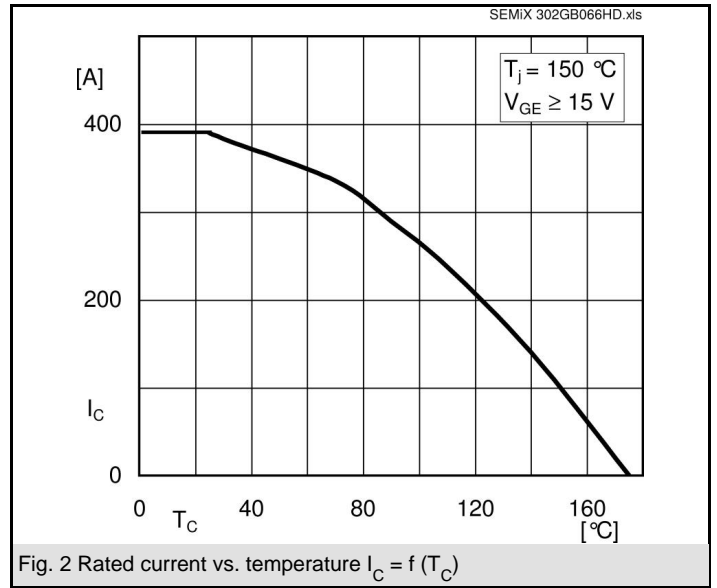
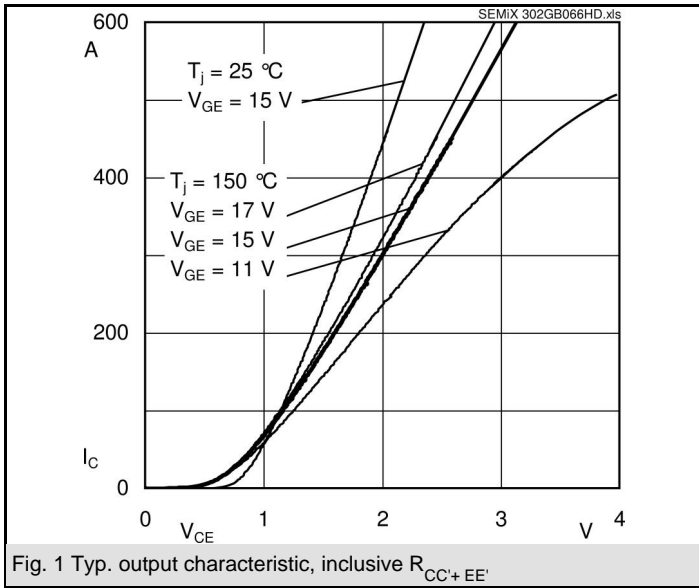

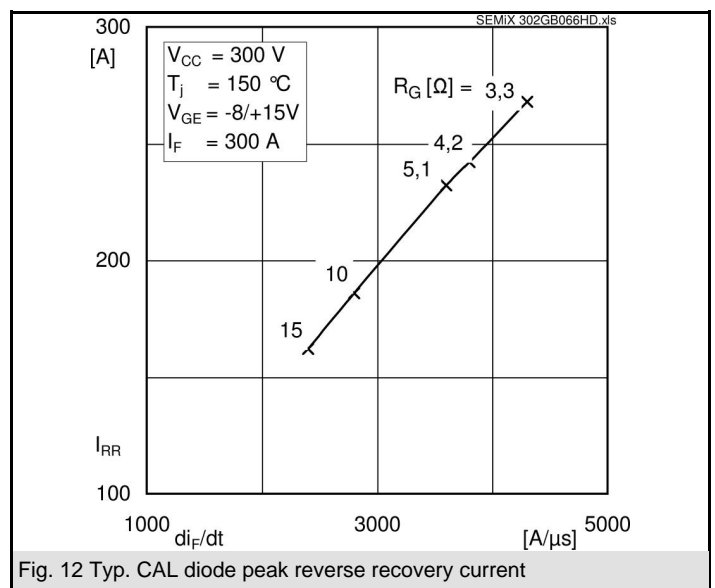
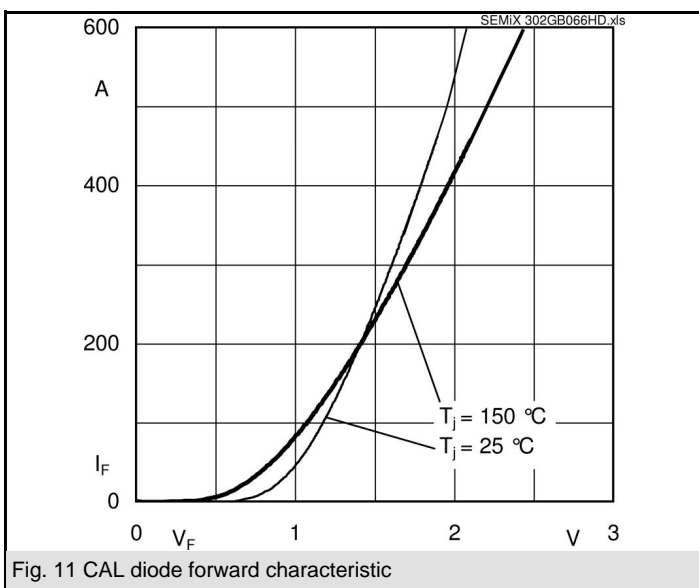
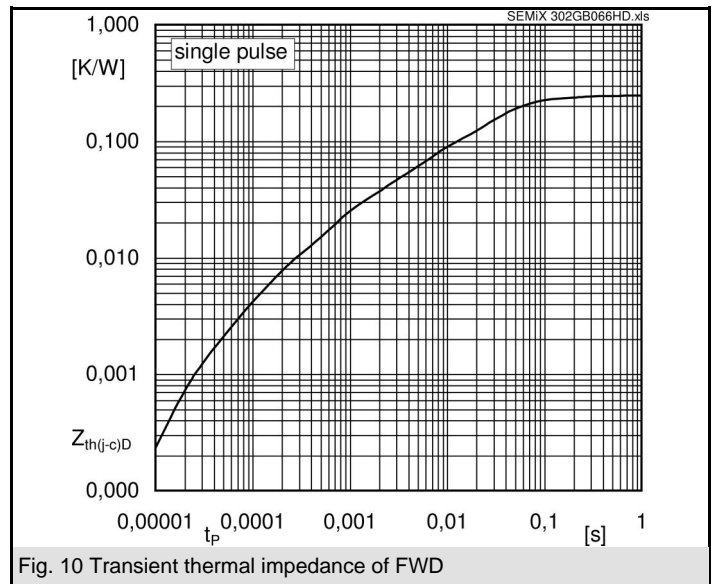
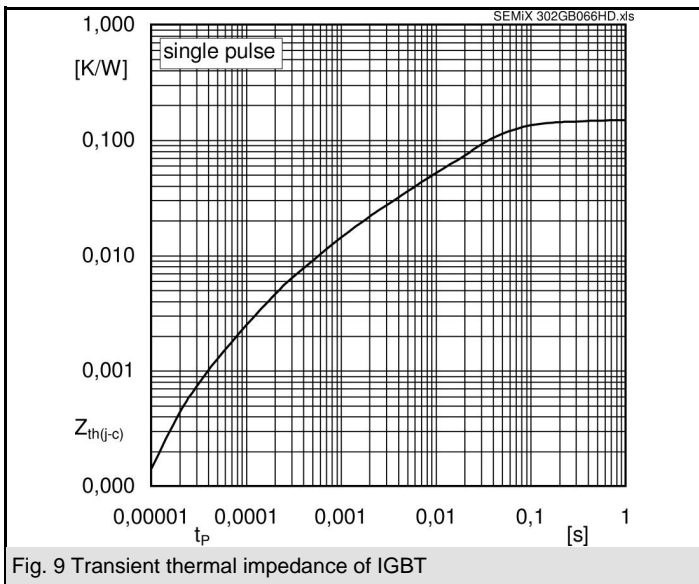
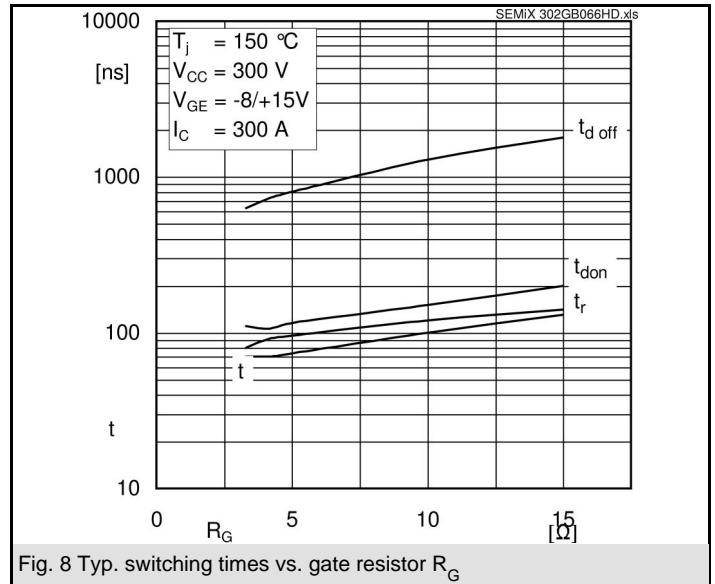
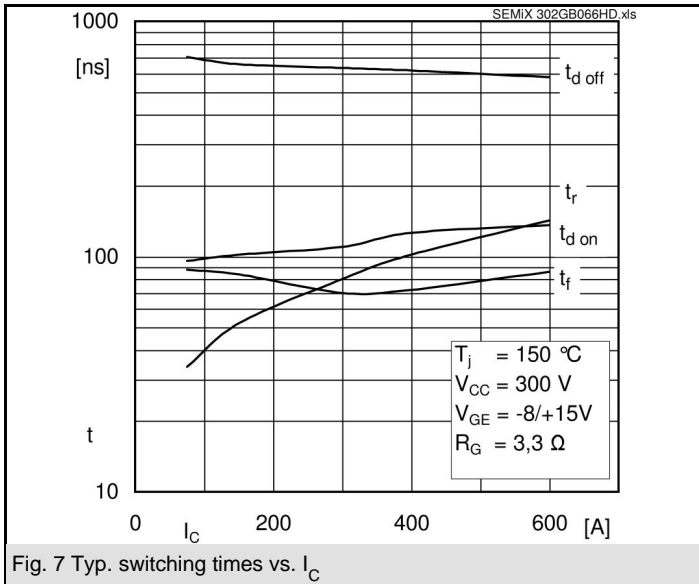

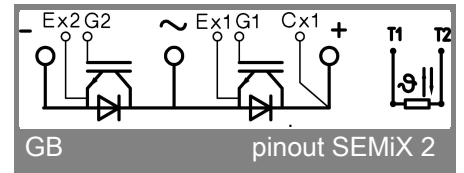
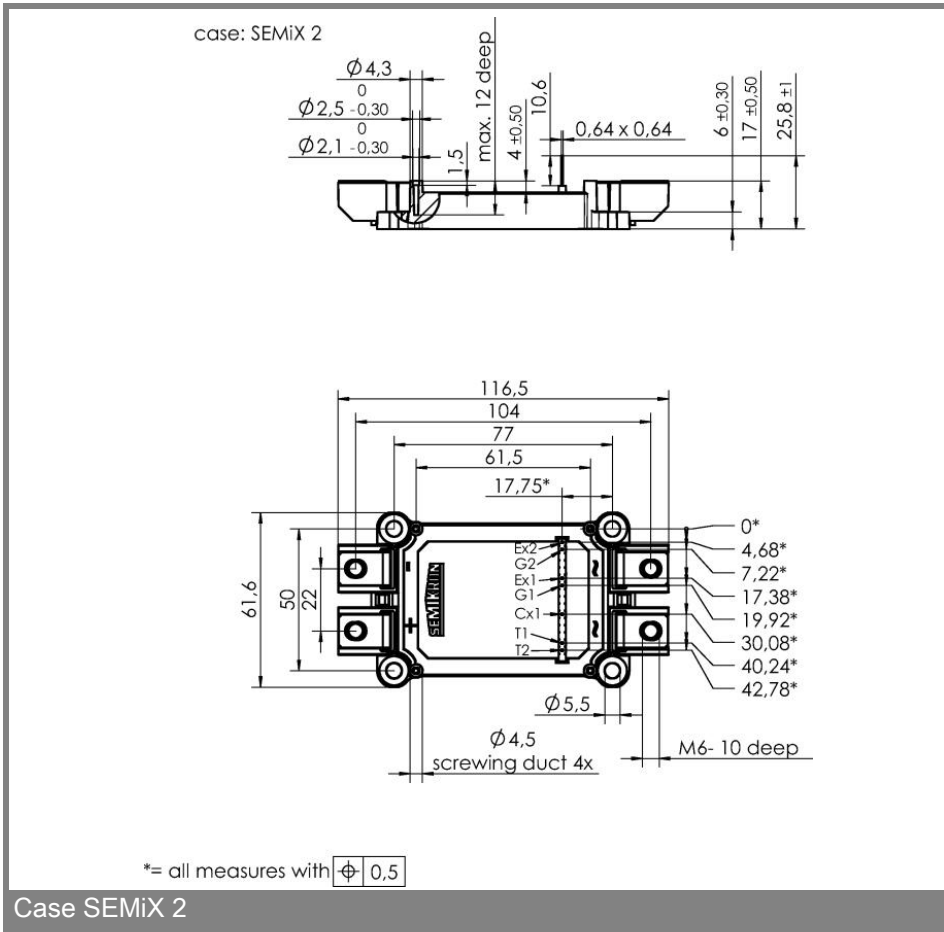
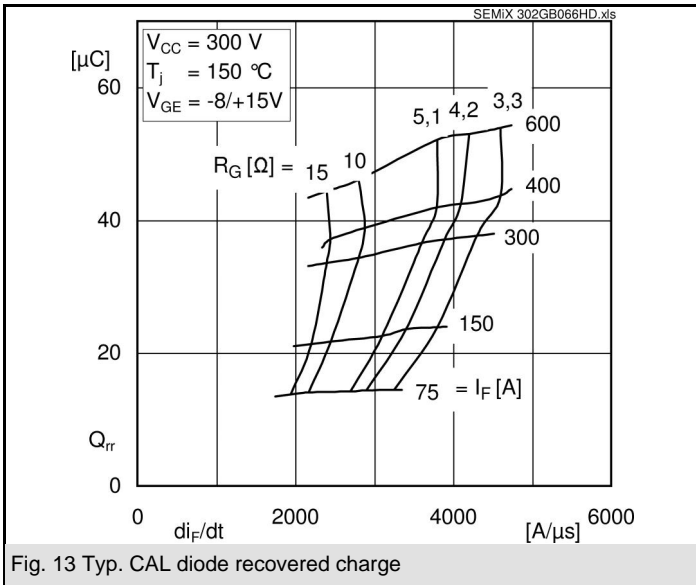

This is an electrostatic discharge sensitive device (ESDS), international standard IEC 60747-1, Chapter IX.

This technical information specifies semiconductor devices but promises no characteristics. No warranty or guarantee expressed or implied is made regarding delivery, performance or suitability.