

DATA SHEET

AV131-315, AV131-315LF: HIP3™ Variable Attenuator for AMPS and GSM Base Stations

Features

- 23 dB attenuation range
- 1.5 dB insertion loss, 1.5 SWR
- 0–12 V control voltage
- 43 dBm IP3
- Small footprint LGA package
- Designed for AMPS and GSM base stations
- Available lead (Pb)-free MSL-1 @ 240 °C per JEDEC J-STD-020

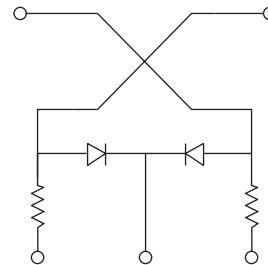

Description

The AV131-315 is a voltage controlled variable attenuator from Skyworks' series of HIP3™ components. It is specifically designed and specified for use as a wide dynamic range low distortion attenuator for AMPS and GSM base station applications centered at 881.5 MHz and 942.5 MHz. The AV131-315 employs a monolithic quadrature hybrid and a pair of silicon PIN diodes to achieve the specified low distortion performance. It operates from 0–12 V at 1.6 mA typical control current at maximum attenuation. The AV131-315 is packaged in a small outline LGA (Land Grid Array) surface mount package with the internal elements affixed to an organic BT substrate.

NEW Skyworks offers lead (Pb)-free, RoHS (Restriction of Hazardous Substances)-compliant packaging.



Electrical Specifications at 25 °C

Parameter	Condition	Min.	Typ.	Max.	Unit
AMPS frequency range (BW)		869		894	MHz
GSM frequency range (BW)		925		960	MHz
Control voltage (C_V) range		0		12	V
Insertion loss in BW	$C_V = 0$ V			1.5	dB
Attenuation range	At F_0 , $C_V = 10$ V	18		22	dB
	At F_0 , $C_V = 12$ V	23		–	dB
VSWR in BW				1.5	
IP3	900/905 MHz, $C_V = 0$ V	43			dBm
IM3	8 dBm			-70	dBc

Typical Performance Data

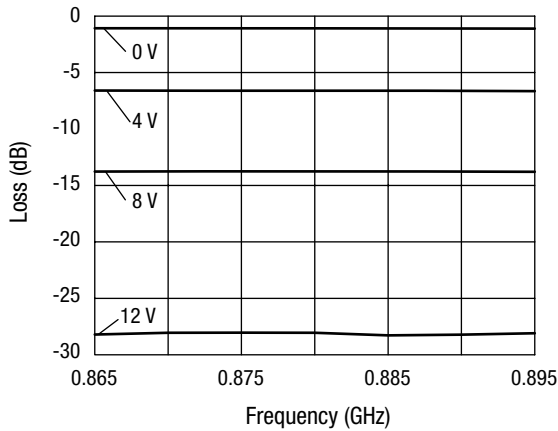

Insertion Loss vs. Frequency and Control Voltage — AMPS Band

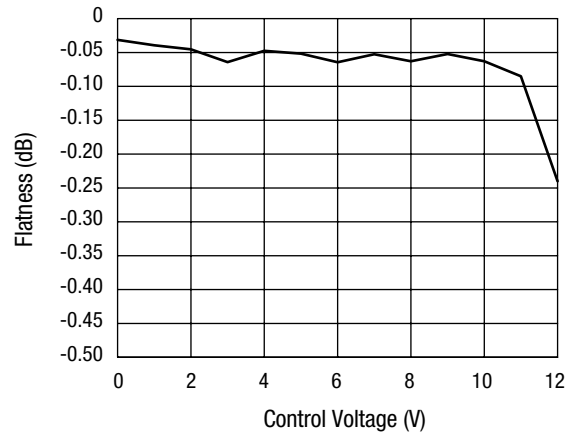

Insertion Loss Flatness vs. Control Voltage — AMPS Band

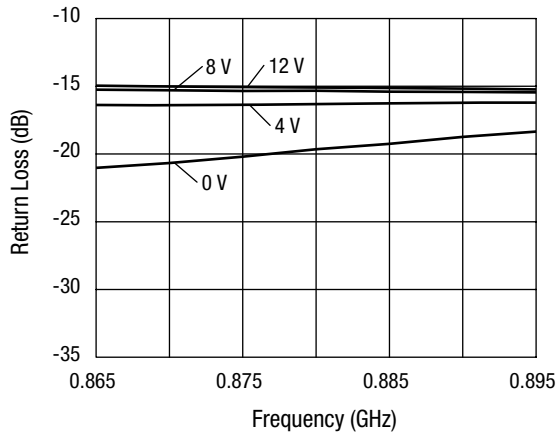

Input/Output Return Loss vs. Frequency and Control Voltage — AMPS Band

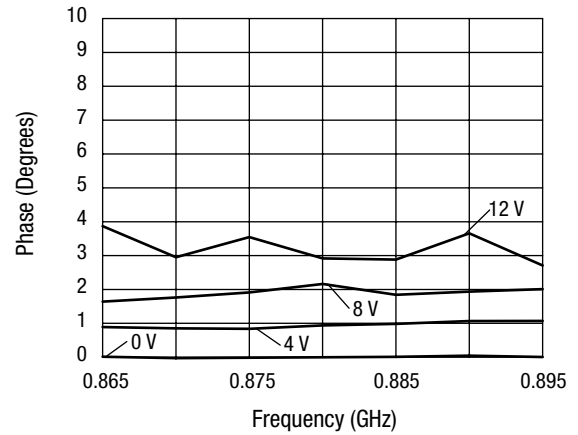

Phase vs. Frequency and Control Voltage — AMPS Band

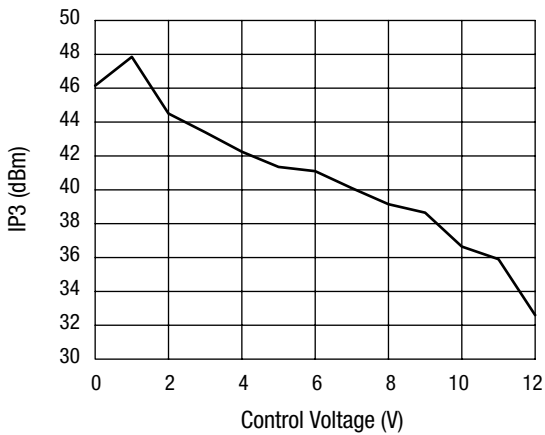

3rd Order Intermod vs. Control Voltage
RF₁ = 0.900 GHz, RF₂ = 0.905 GHz @ 8 dBm

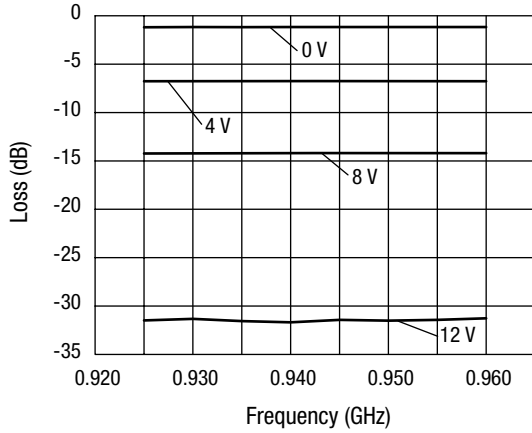

Insertion Loss vs. Frequency and Control Voltage — GSM Band

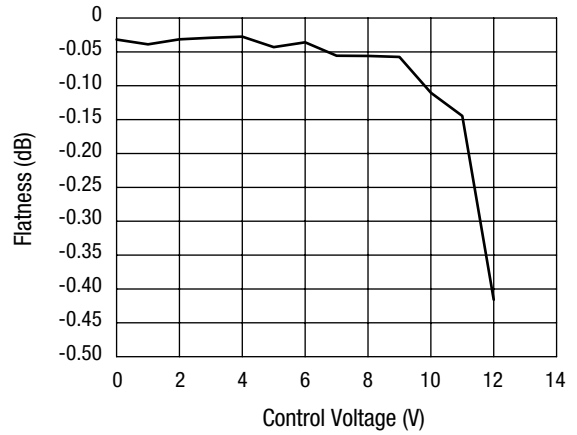

Insertion Loss Flatness vs. Control Voltage — GSM Band

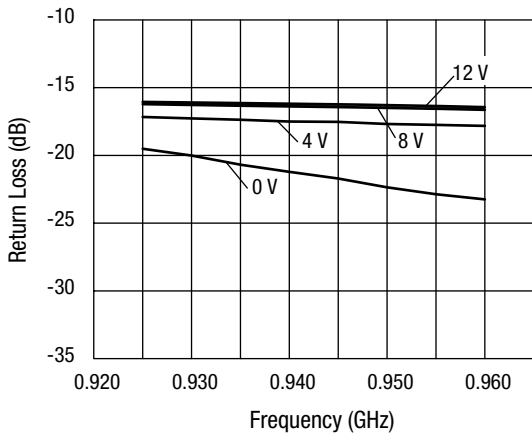

Input/Output Return Loss vs. Frequency and Control Voltage — GSM Band

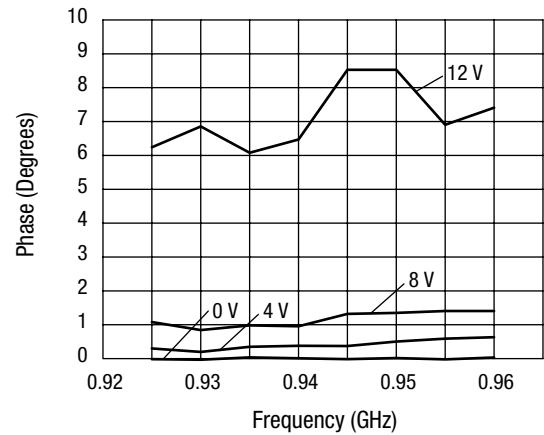

Phase vs. Frequency and Control Voltage — GSM Band

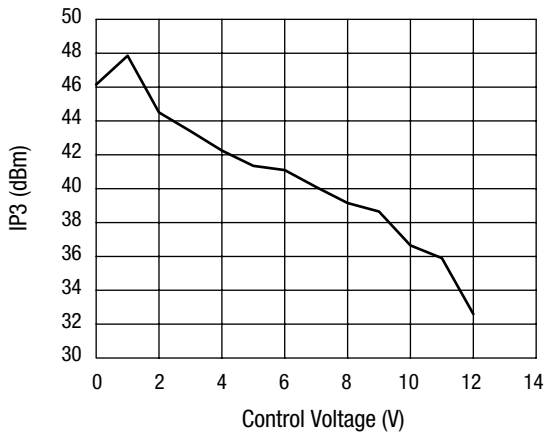

3rd Order Intermod vs. Control Voltage
 $RF_1 = 0.900 \text{ GHz}$, $RF_2 = 0.905 \text{ GHz}$ @ 8 dBm

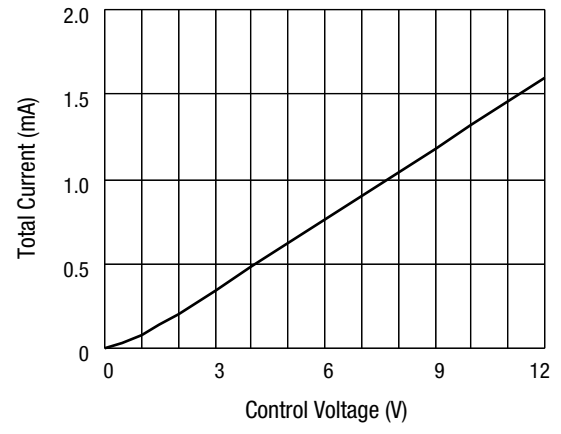

Total Current vs. Control Voltage

Pin Out (Bottom View)

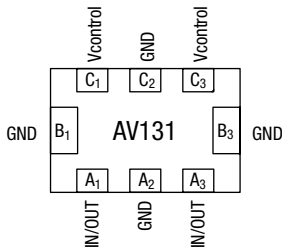

Terminal No.	Terminal Name
A ₁ (Pin 1)	IN/OUT
A ₂	GND
A ₃	IN/OUT
B ₁	GND
B ₂	GND
B ₃	GND
C ₁	Vcontrol
C ₂	GND
C ₃	Vcontrol

Absolute Maximum Ratings

Characteristic	Value
RF input power	0.5 W CW, 4 W @ 12.5% Duty cycle
Control voltage	15 V
Control current	50 mA each diode
Operating temperature	-40 to +85 °C
Storage temperature	-40 to +85 °C
Maximum reverse diode voltage	-10 V
Electrostatic discharge	+250 V

Note: Operating this device above any of these parameters may cause irreversible damage.

Connection Diagram

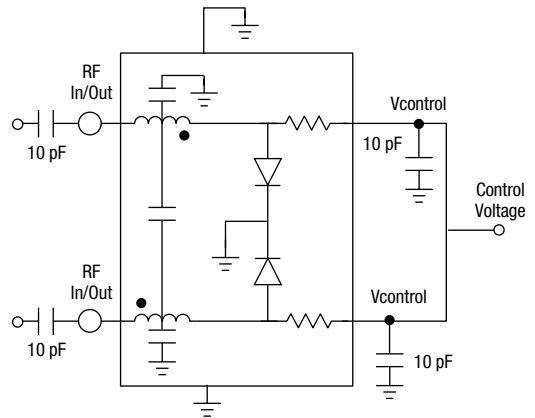

-315

