

**Data Sheets of AVA Technology
Chip Type White LED**

Model : S281208

AVA Technology CO., LTD.

**2640 S. Myrtle Ave. Suite 6
Monrovia, CA 91016, USA**

P: 626-574-7726

F: 626-574-7732

<http://www.led4life.com>

Power Side Lighting LED with Reflector

1. FEATURES

- High intensity with small package, ideal for backlighting
- Wide viewing angle (115°)
- Package Outline (L×W×H)= 2.8×1.2×0.80 mm
- Technology : InGaN
- Color coordinates CIE(x,y) : (0.30,0.30) according to CIE 1931.
- Suitable for all SMT assembly methods
- Suitable for all soldering methods
- Delivery on 8 mm tape reels



2. APPLICATIONS

Automotive: indoor lighting.
 Signal and symbol lightings
 Backlighting (mobile phones, displays, PDA, Digital Camera.....)
 All applications in notice high intensities are required

3. DEVICES PACKAGE

ITEM	MATERIALS
Package	Heat-Resistant Polymer
Encapsulating	Heat Resistance Resin
Electrodes	Ag Plating Copper Alloy

Type	Color of Emission	Color of the Light Emitting Area	Luminous intensity I _v (mcd) I _F = 15mA
S281208	White	Colored	610 ~ 1170

4. OUTLINE DIMENSION:

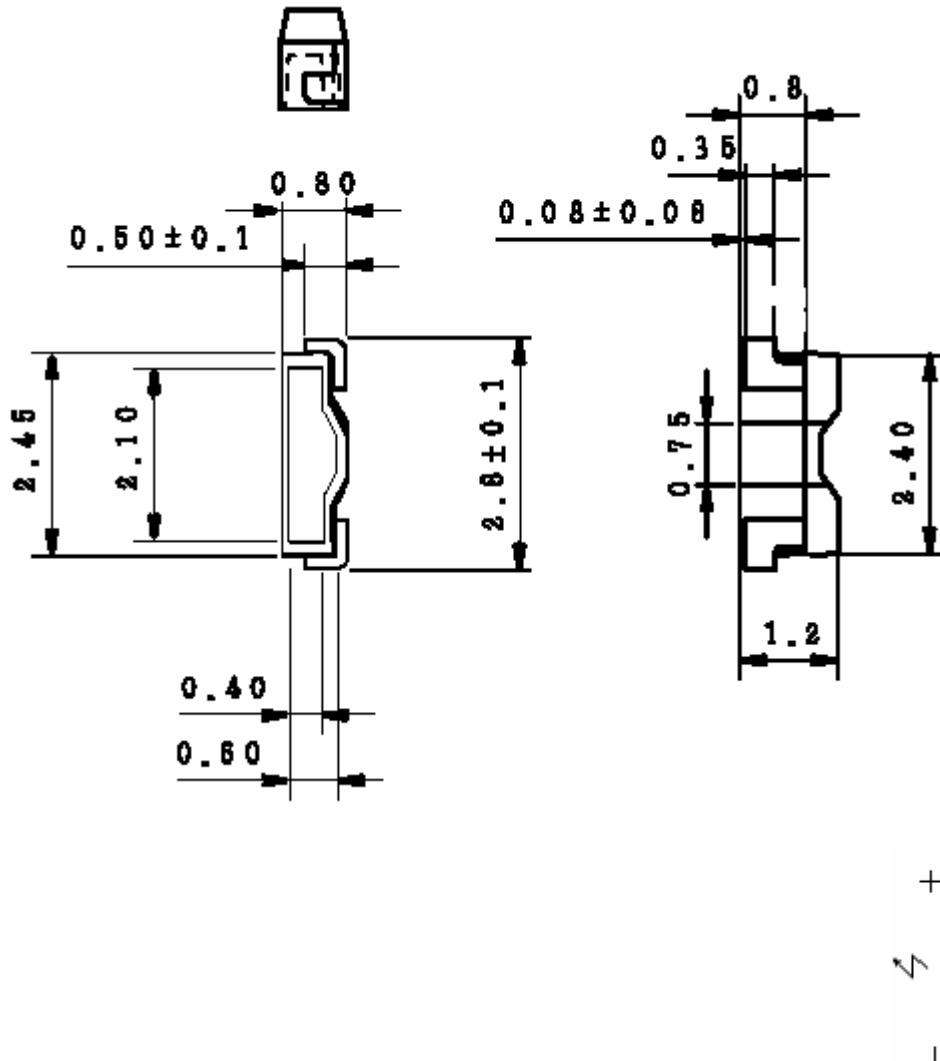

Note:
 1. Unit: mm
 2. Tolerance: Dimension ± 0.1 / Angle $\pm 0.5^\circ$

5. ABSOLUTE MAXIMUM RATINGS (Ta=25°C)

Parameter	Symbol	Absolute Max. Rating	Unit
Forward Current	I _F	30	mA
Operating Temperature	T _{opr}	-30 ~ +85	°C
Storage Temperature	T _{stg}	-40 ~ +100	°C
Soldering Temperature	T _{sol}	260 (for 5 sec)	°C
Power Dissipation	P _D	114	mW
Peak Forward Current (Duty 1/10 @ 1KHz)	I _{F(peak)}	60	mA
Junction temperature	T _j	105	°C
Thermal Resistance (Junction to ambient)	R _{th, JA}	750	°C/W

6. ELECTRONIC OPTICAL CHARACTERISTICS

Parameter	Symbol	Condition	Min.	Typ.	Max.	Unit
Chromaticity coordinate x acc. To CIE 1931	X	I _F =15mA	---	0.30	---	---
Chromaticity coordinate y acc. To CIE 1931	Y	I _F =15mA	---	0.30	---	---
Viewing Angle	2θ _{1/2}	I _F =15mA	---	115	---	Degree
Forward Voltage	V _F	I _F =15mA	---	3.10	3.40	V
Leakage Current	I _R	V _R = -5V	---	---	10	μA
Forward Resistance _(Note 1)	R _F	---	4.0	---	---	MΩ
Forward Resistance _(Note 2)	R _F	---	21	---	---	MΩ
Forward Resistance _(Note 3)	R _F	---	20	---	---	MΩ

Note 1 : Special specification for P/N : S281208-M-F only.

Note 2 : Special specification for P/N : S281208-M3-F only.

Note 3 : Special specification for P/N : S281208-M2-F only.

7. LUMINOUS INTENSITY GROUPS:

Iv Bin	Measurement condition	Luminous intensity Iv(mcd)
T211F	I _F = 15 mA	610-650
T212F		650-690
T221F		690-730
T222F		730-770
U11F		770-810
U12F		810-850
U13F		850-890
U14F		890-930
U15F		930-970
U16F		970-1010
U21F		1010-1050
U22F		1050-1090
U23F		1090-1130
U24F		1130-1170

* Luminous intensity group includes 14 groups T211F to U24F.

* Luminous intensity is tested at a current pulse duration of 25ms and a tolerance of $\pm 10\%$.

8. CHROMATICITY COORDINATES :

* CIE(x,y) Ranks

I _F @ 15mA								
Rank	x	y	Rank	x	y	Rank	x	y
k00	0.2300	0.2000	k22	0.2425	0.2000	k44	0.2525	0.2000
	0.2375	0.2000		0.2475	0.2000		0.2575	0.2000
k01	0.2475	0.2200	k23	0.2575	0.2200	k45	0.2675	0.2200
	0.2400	0.2200		0.2525	0.2200		0.2625	0.2200
k02	0.2400	0.2200	k24	0.2525	0.2200	k46	0.2625	0.2200
	0.2475	0.2200		0.2575	0.2200		0.2675	0.2200
k04	0.2625	0.2500	k26	0.2725	0.2500	k48	0.2825	0.2500
	0.2550	0.2500		0.2675	0.2500		0.2775	0.2500
k05	0.2550	0.2500	k27	0.2675	0.2500	k49	0.2775	0.2500
	0.2625	0.2500		0.2725	0.2500		0.2825	0.2500
k07	0.2775	0.2800	k29	0.2875	0.2800	k51	0.2975	0.2800
	0.2700	0.2800		0.2825	0.2800		0.2925	0.2800
k08	0.2700	0.2800	k30	0.2825	0.2800	k52	0.2925	0.2800
	0.2775	0.2800		0.2875	0.2800		0.2975	0.2800
k10	0.2925	0.3100	k32	0.3025	0.3100	k54	0.3125	0.3100
	0.2850	0.3100		0.2975	0.3100		0.3075	0.3100
k11	0.2375	0.2000	k33	0.2475	0.2000	k55	0.2575	0.2000
	0.2425	0.2000		0.2525	0.2000		0.2650	0.2000
k12	0.2525	0.2200	k34	0.2625	0.2200	k56	0.2750	0.2200
	0.2475	0.2200		0.2575	0.2200		0.2675	0.2200
k13	0.2475	0.2200	k35	0.2575	0.2200	k57	0.2675	0.2200
	0.2525	0.2200		0.2625	0.2200		0.2750	0.2200
k15	0.2675	0.2500	k37	0.2775	0.2500	k59	0.2900	0.2500
	0.2625	0.2500		0.2725	0.2500		0.2825	0.2500
k16	0.2625	0.2500	k38	0.2725	0.2500	k60	0.2825	0.2500
	0.2675	0.2500		0.2775	0.2500		0.2900	0.2500
k18	0.2825	0.2800	k40	0.2925	0.2800	k62	0.3050	0.2800
	0.2775	0.2800		0.2875	0.2800		0.2975	0.2800
k19	0.2775	0.2800	k41	0.2875	0.2800	k63	0.2975	0.2800
	0.2825	0.2800		0.2925	0.2800		0.3050	0.2800
k21	0.2975	0.3100	k43	0.3075	0.3100	k65	0.3200	0.3100
	0.2925	0.3100		0.3025	0.3100		0.3125	0.3100

* CIE rank can be sorted by 0.01~0.015

* CIE(x,y) tolerance±0.007

* Chromaticity Coordinates (CIE 1931 system)

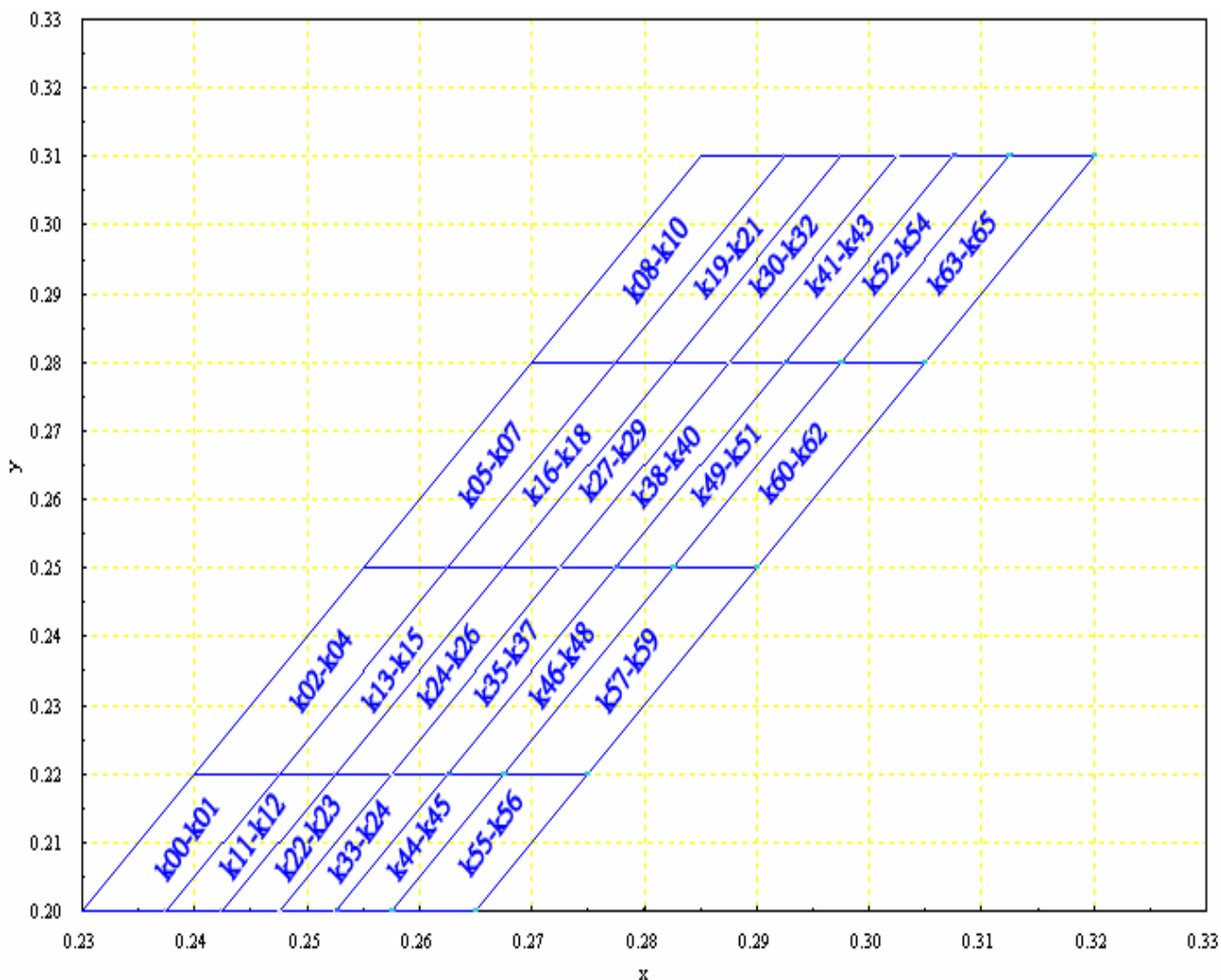

9. FORWARD VOLTAGE

I _F @ 15mA	
Bin	V _F (Volt)
Vb	2.80-2.90
Va	2.90-3.00
V0	3.00-3.10
V1	3.10-3.20
V2	3.20-3.30
V3	3.30-3.40

*V_F tolerance ±0.05V

10. TYPICAL ELECTRO-OPTICAL CHARACTERISTIC CURVES:

*** Forward Voltage vs. Forward Current**

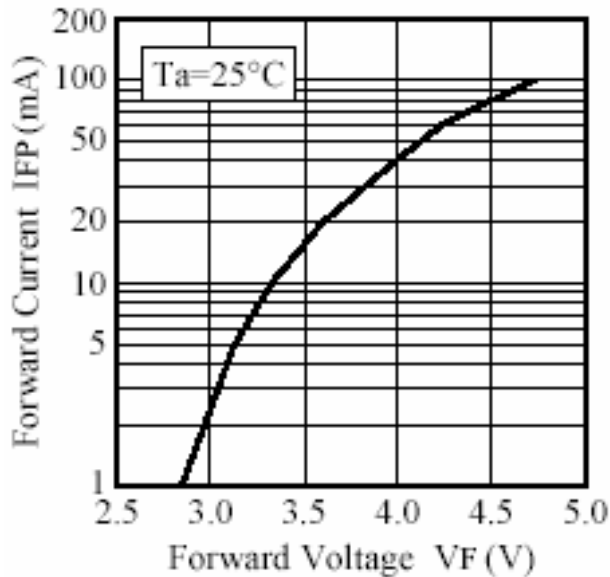

*** Forward Current vs. Relative Luminosity**

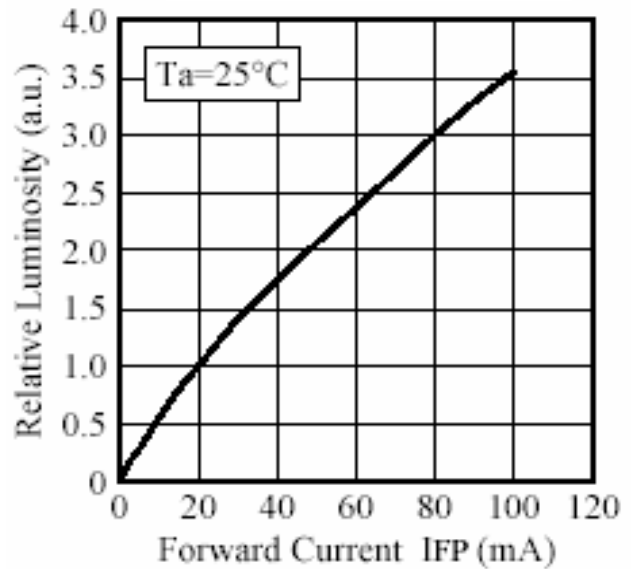

*** Ambient Temperature vs. Allowable Forward Current**

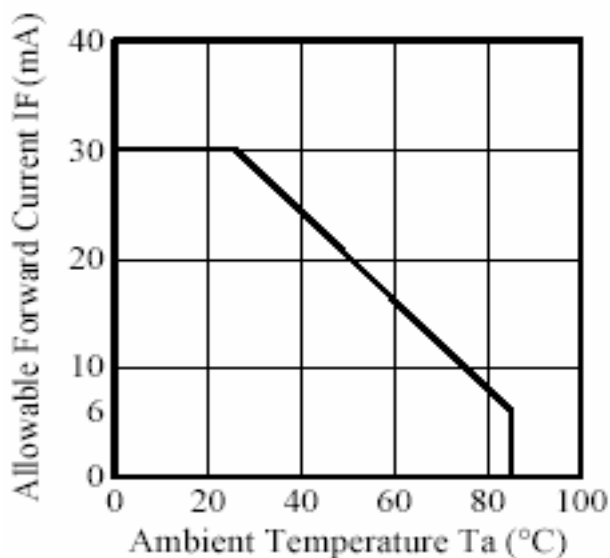

*** Ambient Temperature vs. Forward Voltage**

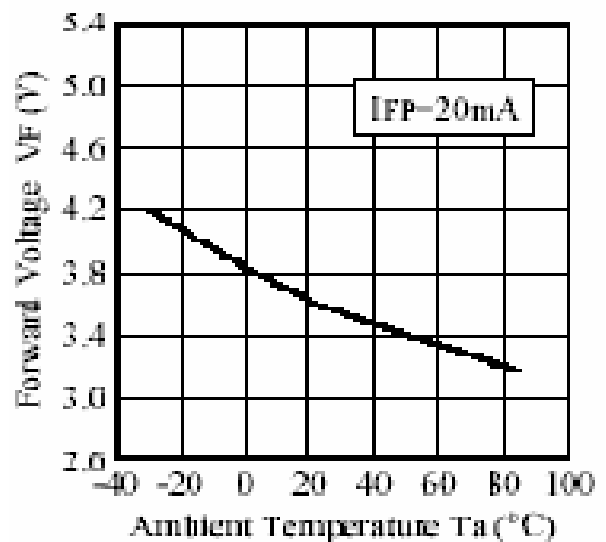

*** Forward Current vs. Chromaticity Diagram**

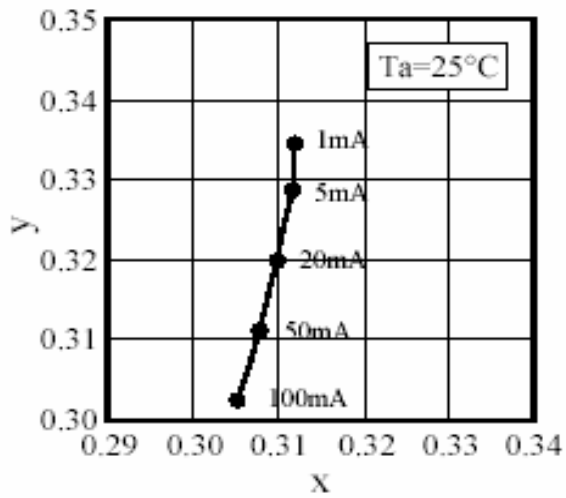

*** Spectrum**

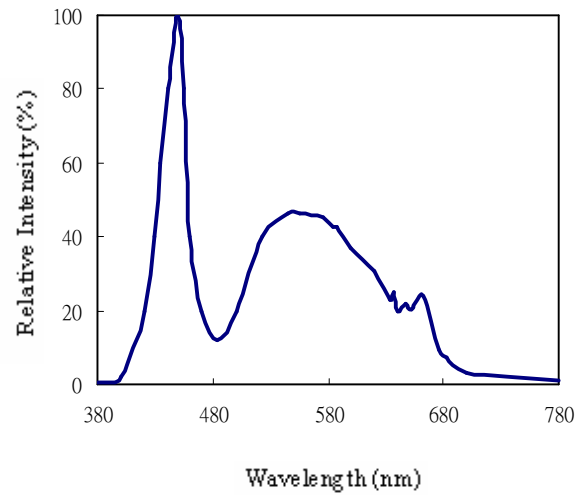

*** Ambient Temperature vs. Chromaticity Diagram**

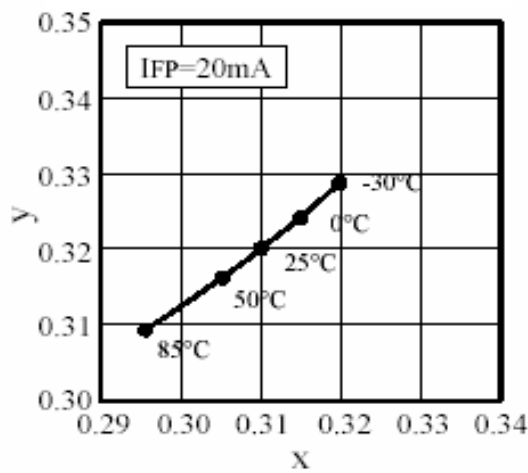

*** Radiation Characteristic (@ 25°C, 20mA)**

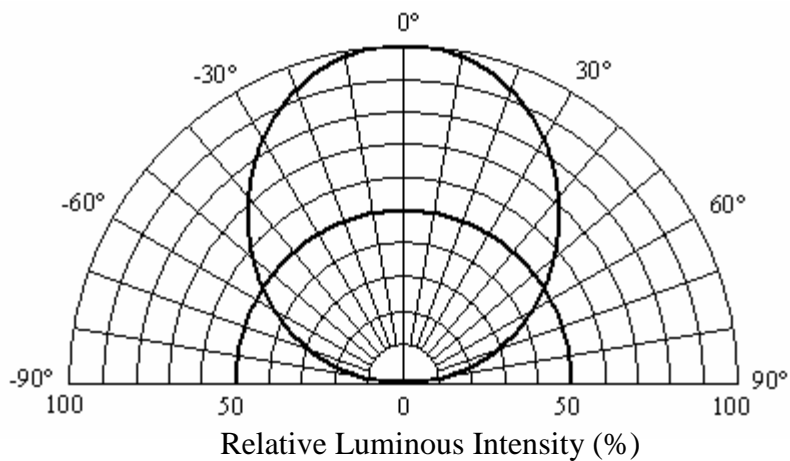

11. REEL PACKAGE:

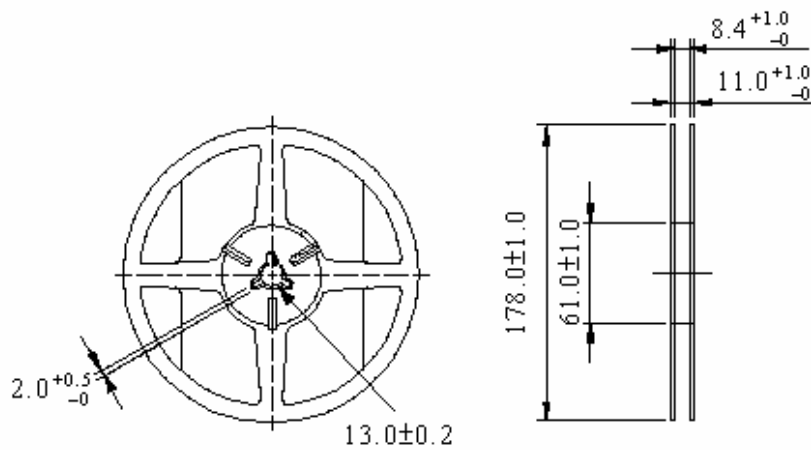
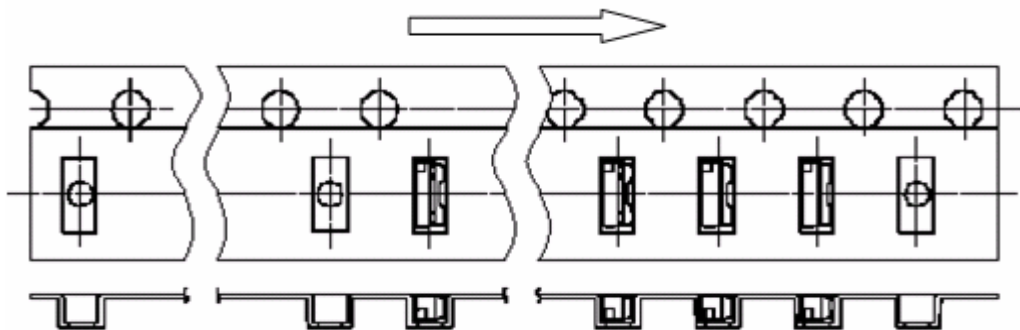
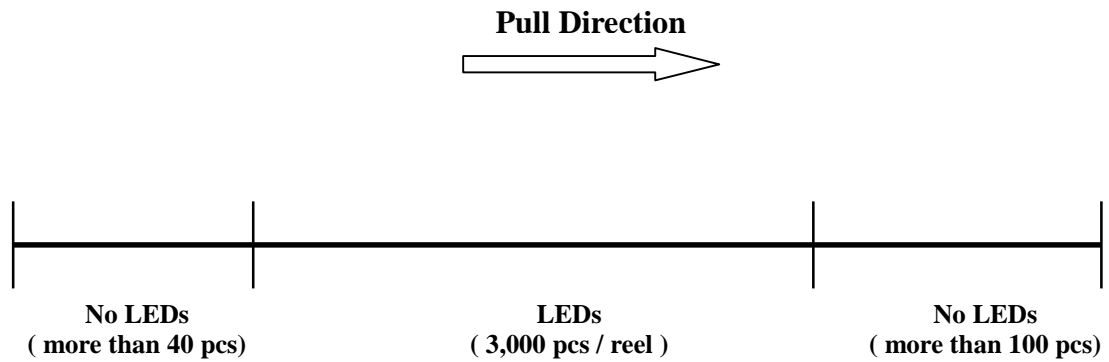

Note:
 1. Unit: mm
 2. 3,000 pcs / reel

12. RELIABILITY PLAN:

* The reliability of products shall be satisfied with items listed below.

Confidence Level : 90 % , LTPD : 10 %

No	Test Item	Description & Condition		Sample size	Ac/Re	Failure Criteria
1	Solderability	Tsld =245±5°C, 10sec,	1 time	22	0/1	IV < L* 0.6 (I _F : 20mA) V _F > U * 1.1 (I _F : 20mA) I _R > U * 2.0 (V _R :5V) L: Lower Spec. Level U: Upper Spec. Level
2	Room Temperature operating	Ta = 25 °C I _F = 20mA	1000 hrs	22	0/1	
3	Room Temperature operating	Ta = 25 °C I _F = 30mA	500 hrs	22	0/1	
4	Low Temperature Storage	Ta = -40 °C	1000 hrs	22	0/1	
5	High Temperature Storage	Ta = 100 °C	1000 hrs	22	0/1	
6	Temperature Cycle	-40°C ~ 25°C ~ 100°C ~ 25 °C 30min 5min 30min 5 min	100 cycles	22	0/1	
7	High Humidity Heat	Ta = 60 °C RH=90% I _F = 15mA	500 hrs	22	0/1	

13. SOLDERING CONDITIONS:

(1) Recommended Re-flow profile

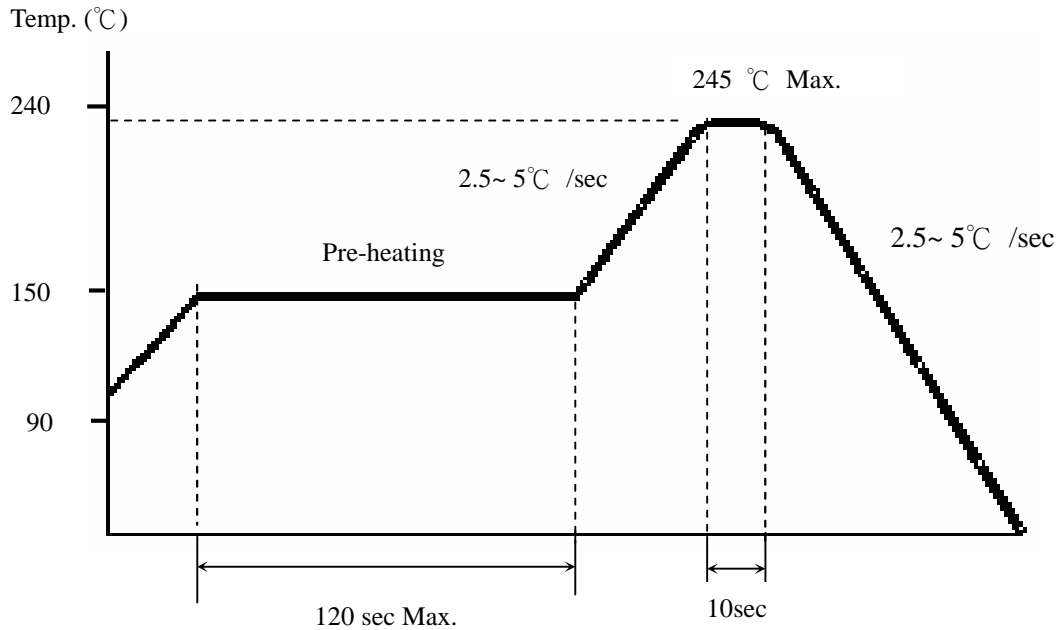

Recommended Soldering Pad

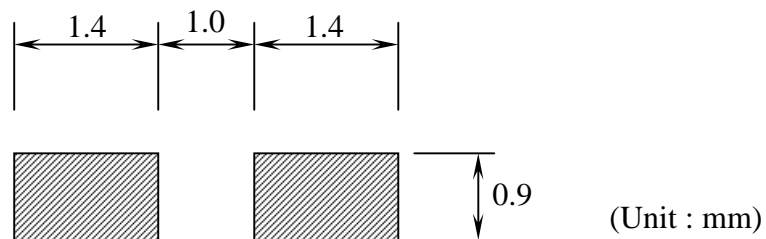

- (2) Re-flow soldering should not be done more than two times.
- (3) It is recommended that the user use the nitrogen reflow method.
- (4) When soldering, don't put stress on the LEDs during heating.
- (5) After soldering, don't warp the circuit board.
- (6) It is recommended that isopropyl alcohol (IPA) be used as a solvent for cleaning the LEDs.

14.CAUTIONS:

(1)Storage

- Before opening the package :

The LEDs should be kept at 30°C or less and 30%RH~85%RH. The LEDs should be used within a year. When storing the LEDs, moisture proof packaging with desiccant (Silica gel)is recommended.

- After opening the package :

The LEDs should be kept at 30°C or less and 30%RH~70%RH.The LEDs should be soldered within 168hours (7days) after opening the package. If unused LEDs remain, they should be stored in moisture proof packages, such as sealed containers with packages of moisture desiccant (Silica gel), or reseal the moisture proof bag again.

If the moisture desiccant (Silica gel) has faded away or the LEDs have exceeded the storage time, baking treatment should be performed using the following conditions.

Baking treatment: more than 24 hours at 65°C.

Please avoid conditions which may cause the LED to corrode, tarnish or discolor. This corrosion or discoloration might lower solderability or might effect on optical characteristics. Please avoid rapid transitions in ambient temperature, especially in high humidity environments where condensation can occur.

- Moisture Proof package

When moisture is absorbed into the SMT package it may vaporize and expand during soldering. There is a possibility that this can cause exfoliation of the contacts and damage to the optical characteristics of the LEDs. For this reason, the moisture proof package is used to keep moisture to a minimum in the package. A package of a moisture desiccant (silica gel)is inserted into the moisture proof bag. The silica gel changes its color from blue to pink as it absorbs moisture.

(2)Static Electricity

- Static electricity or surge voltage damages the LEDs. It is recommended that a wrist band or an anti-electrostatic glove and shoe be used when handling the LEDs.
- All devices, equipment and machinery must be properly grounded. It is recommended that measures be taken against surge voltage to the equipment that mounts the LEDs.
- When inspecting the final products in which LEDs were assembled, it is recommended to check whether the assembled LEDs are damaged by static electricity or not. It is easy to End static-damaged LEDs by a light-on test or a V_F test at a lower current (below 1 mA).
- Damaged LEDs will show some unusual characteristics such as the leak current remarkably increases, the forward voltage becomes lower, or the LEDs do not light at the low current. (Criteria : $V_F > 2.0V$ at $I_F = 0.5mA$.)

(3)Heat Generation

- Please consider the heat generation of the LED when making the system design that it's very importance. The coefficient of temperature increase per input electric power is affected by the thermal resistance of the circuit board and density of LED placement on the board, and other components. It is necessary to avoid intense heat generation and operate within the maximum ratings given in this specification.
- The operating current should be decided after considering the ambient maximum temperature of LEDs.

(4)Others

- Care must be taken to ensure that the reverse voltage will not exceed the absolute maximum rating when using the LEDs with matrix drive.
- The LED light output is strong enough to injure human eyes. Precautions must be taken to prevent looking directly for more than a few seconds. Flashing lights have been known to cause discomfort in people; you can prevent this by taking precautions during use. Also, people should be cautious when using equipment that has had LEDs incorporated into it.

Copyright, Trademarks and Patents

AVA TECHNOLOGY CO. MAKES NO WARRANTY, REPRESENTATION OF GUARANTEE, EXPRESS OR IMPLIED, REGARDING THE SUITABILITY OF ITS PRODUCTS FOR ANY PARTICULAR PURPOSE, NOR THAT THE USE OR APPLICATION AND SPECIFICALLY DISCLAIMS ANY AND ALL LIABILITY ARISING OUT OF ANY SUCH USE OR APPLICATION, INCLUDING BUT NOT LIMITED TO, CONSEQUENTIAL OR INCIDENTAL DAMAGES.

AVA Technology Co. are not designed, intended or authorized for use as components in systems intended for surgical implant into the body, or other applications intended to support or sustain life, or for any other application in which the failure of the AVA Technology Co. Product could create a situation where personal injury or death may occur.

AVA Technology Co. reserves the right to make changes to or discontinue any product or service described herein without notice.

AVA Technology Co.

World Wide Web

<http://www.led4life.com>