

SEMiX 202GB066HDs



SEMiX[®] 2s

Trench IGBT Modules

SEMiX 202GB066HDs

Preliminary Data

Features

- Homogeneous Si
- Trench = Trenchgate technology
- $V_{CE(sat)}$ with positive temperature coefficient

Typical Applications

- Matrix Converter
- Resonant Inverter
- Current Source Inverter

Remarks

- Case temperature limited to $T_C=125^\circ\text{C}$ max.
- Product reliability results are valid for $T_j=150^\circ\text{C}$
- use of soft RG necessary
- take care of over-voltage caused by stray inductance



GB

Absolute Maximum Ratings		$T_{case} = 25^\circ\text{C}$, unless otherwise specified		
Symbol	Conditions	Values	Units	
IGBT				
V_{CES}	$T_j = 25^\circ\text{C}$	600	V	
I_C	$T_j = 175^\circ\text{C}$	$T_c = 25^\circ\text{C}$	275	A
		$T_c = 80^\circ\text{C}$	205	A
I_{CRM}	$I_{CRM} = 2 \times I_{Cnom}$	400	A	
V_{GES}		± 20	V	
t_{psc}	$V_{CC} = 360\text{ V}; V_{GE} \leq 15\text{ V}; T_j = 150^\circ\text{C}$ $V_{CES} < 600\text{ V}$	6	μs	
Inverse Diode				
I_F	$T_j = 175^\circ\text{C}$	$T_c = 25^\circ\text{C}$	290	A
		$T_c = 80^\circ\text{C}$	210	A
I_{FRM}	$I_{FRM} = 2 \times I_{Fnom}$	400	A	
I_{FSM}	$t_p = 10\text{ ms}; \text{sin.}$	$T_j = 25^\circ\text{C}$	1000	A
Module				
$I_{t(RMS)}$		600	A	
T_{vj}		- 40 ... + 175	$^\circ\text{C}$	
T_{stg}		- 40 ... + 125	$^\circ\text{C}$	
V_{isol}	AC, 1 min.	4000	V	

Characteristics		$T_{case} = 25^\circ\text{C}$, unless otherwise specified			
Symbol	Conditions	min.	typ.	max.	Units
IGBT					
$V_{GE(th)}$	$V_{GE} = V_{CE}, I_C = 3,2\text{ mA}$		5,8		V
I_{CES}	$V_{GE} = 0\text{ V}, V_{CE} = V_{CES}$			0,45	mA
V_{CE0}		$T_j = 25^\circ\text{C}$	0,9	1	V
		$T_j = 150^\circ\text{C}$	0,85	0,9	V
r_{CE}	$V_{GE} = 15\text{ V}$	$T_j = 25^\circ\text{C}$	2,75	4,5	m Ω
		$T_j = 150^\circ\text{C}$	4,25	6	m Ω
$V_{CE(sat)}$	$I_{Cnom} = 200\text{ A}, V_{GE} = 15\text{ V}$	$T_j = 25^\circ\text{C}_{chiplev.}$	1,45	1,9	V
		$T_j = 150^\circ\text{C}_{chiplev.}$	1,7	2,1	V
C_{res}	$V_{CE} = 25, V_{GE} = 0\text{ V}$	$f = 1\text{ MHz}$	12,1		nF
C_{oes}			0,75		nF
C_{res}			0,35		nF
Q_G	$V_{GE} = -8 \dots +15\text{V}$		1600		nC
$t_{d(on)}$	$R_{Gon} = 4,2\ \Omega$	$V_{CC} = 300\text{V}$ $I_{Cnom} = 200\text{A}$	65		ns
t_r			80		ns
E_{on}	$R_{Goff} = 4,2\ \Omega$	$T_j = 150^\circ\text{C}$	6		mJ
$t_{d(off)}$			545		ns
t_f			95		ns
E_{off}			8		mJ
$R_{th(j-c)}$	per IGBT			0,21	K/W

SEMiX 202GB066HDs



SEMiX® 2s

Trench IGBT Modules

SEMiX 202GB066HDs

Preliminary Data

Features

- Homogeneous Si
- Trench = Trenchgate technology
- $V_{CE(sat)}$ with positive temperature coefficient

Typical Applications

- Matrix Converter
- Resonant Inverter
- Current Source Inverter

Remarks

- Case temperature limited to $T_C=125^\circ\text{C}$ max.
- Product reliability results are valid for $T_j=150^\circ\text{C}$
- use of soft RG necessary
- take care of over-voltage caused by stray inductance



GB

Characteristics		min.	typ.	max.	Units
Symbol	Conditions				
Inverse Diode					
$V_F = V_{EC}$	$I_{Fnom} = 200 \text{ A}; V_{GE} = 0 \text{ V}$		1,4	1,6	V
			1,4		V
V_{F0}			1	1,1	V
			0,85	0,95	V
r_F			2	2,5	mΩ
			2,75	3,25	mΩ
I_{RRM}	$I_{Fnom} = 200 \text{ A}$		205		A
Q_{rr}	$di/dt = 3900 \text{ A}/\mu\text{s}$		28		μC
E_{rr}	$V_{GE} = -8 \text{ V}; V_{CC} = 300 \text{ V}$		6,5		mJ
$R_{th(j-c)D}$	per diode			0,27	K/W
Module					
L_{CE}			18		nH
$R_{CC'+EE'}$	res., terminal-chip	$T_{case} = 25^\circ\text{C}$	0,7		mΩ
		$T_{case} = 125^\circ\text{C}$	1		mΩ
$R_{th(c-s)}$	per module		0,045		K/W
M_s	to heat sink (M5)		3	5	Nm
M_t	to terminals (M6)		2,5	5	Nm
w				250	g
Temperature sensor					
R_{100}	$T_c = 100^\circ\text{C}$ ($R_{25} = 5 \text{ k}\Omega$)		0,493±5%		kΩ
$B_{100/125}$	$R(T) = R_{100} \exp[B_{100/125} (1/T - 1/T_{100})]$; $T[\text{K}]; B$		3550±2%		K

This is an electrostatic discharge sensitive device (ESDS), international standard IEC 60747-1, Chapter IX.

This technical information specifies semiconductor devices but promises no characteristics. No warranty or guarantee expressed or implied is made regarding delivery, performance or suitability.

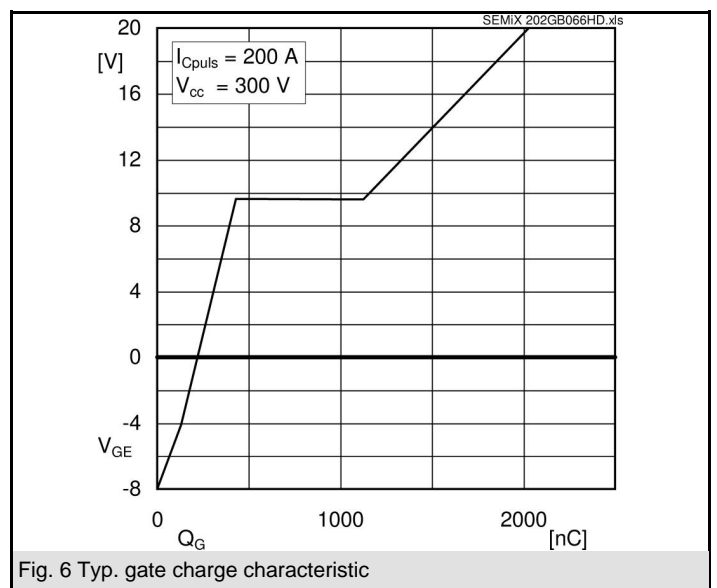
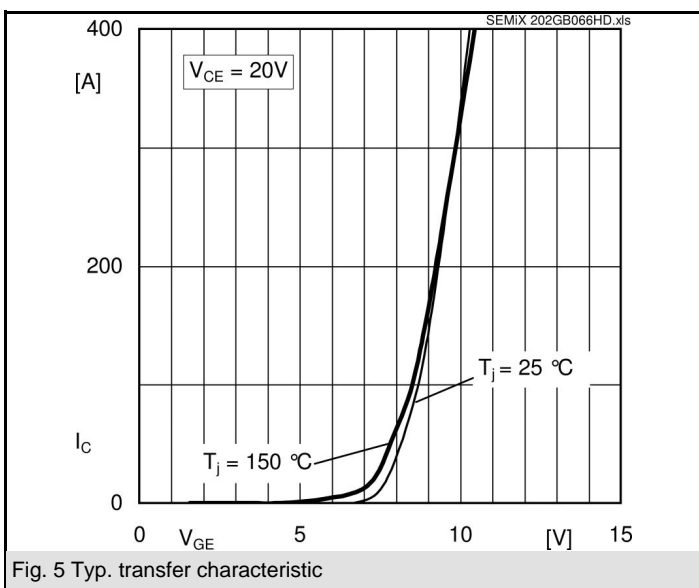
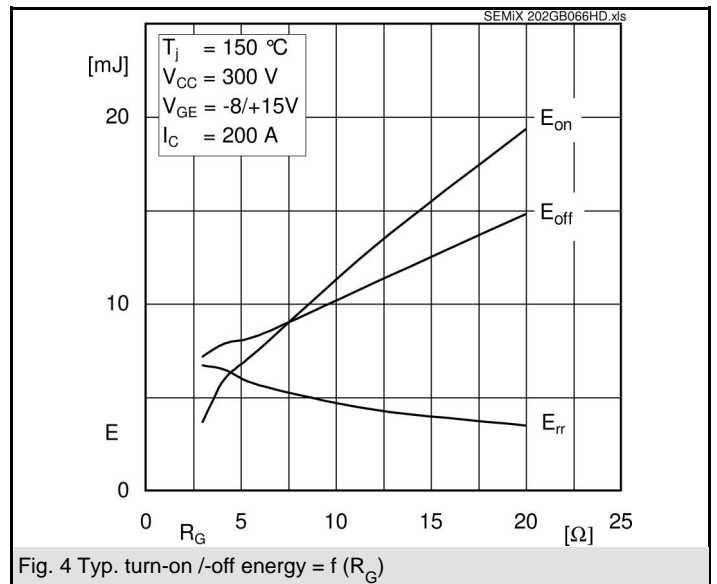
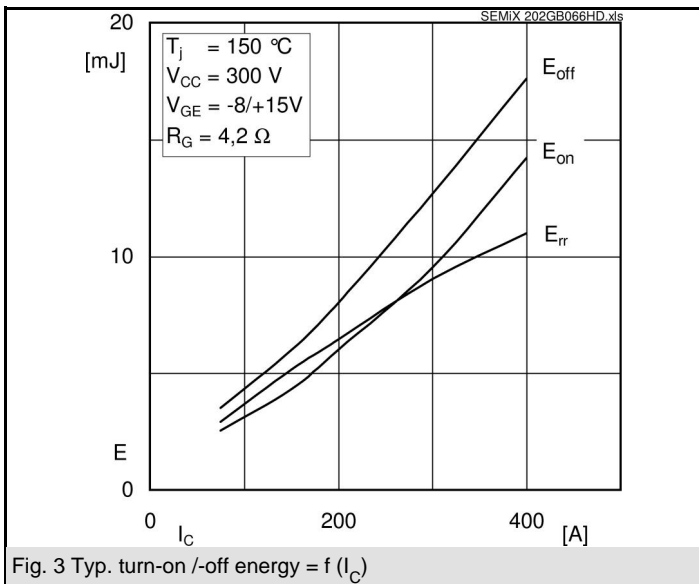
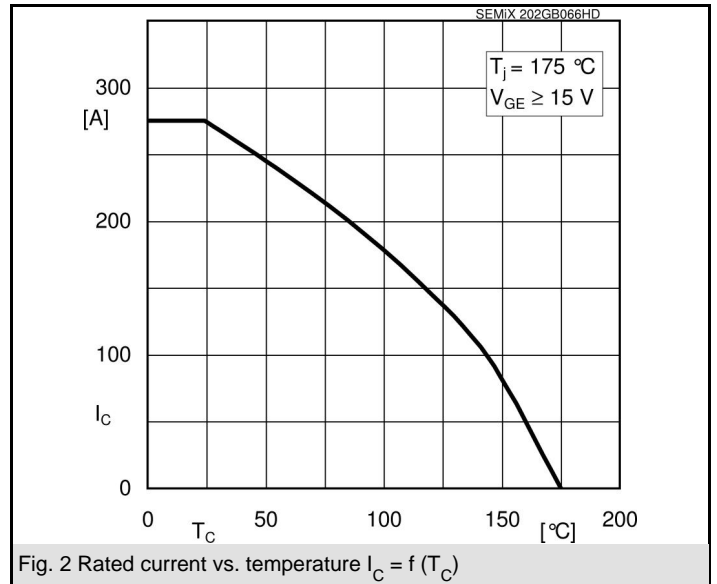
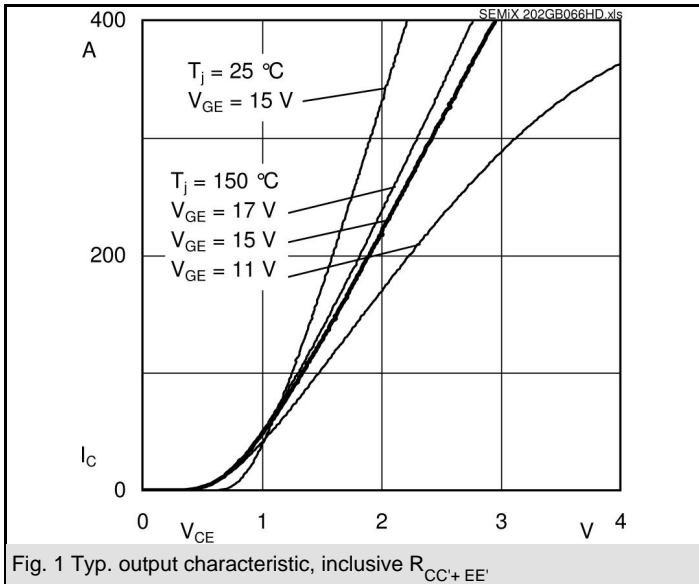

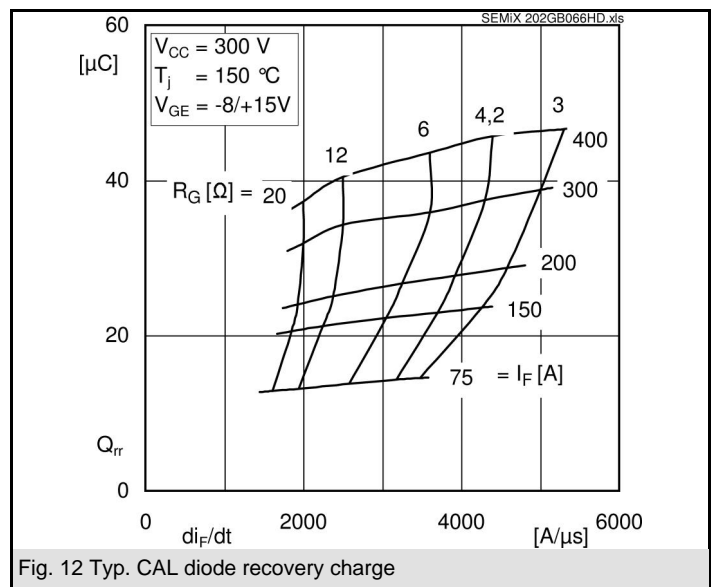
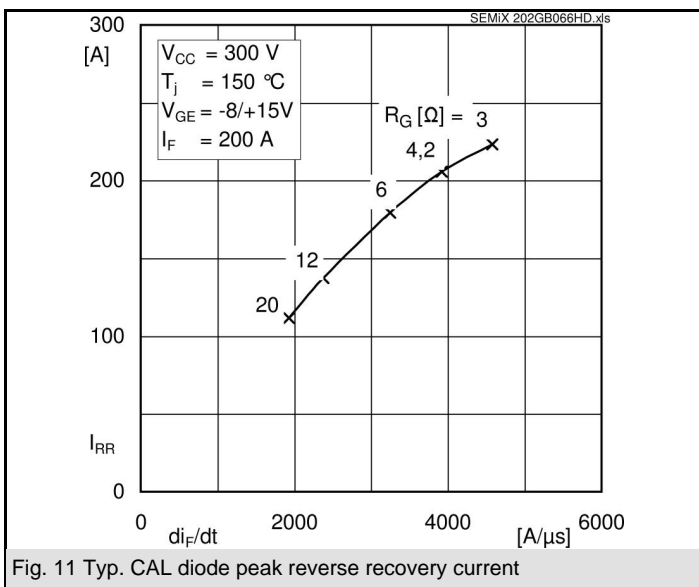
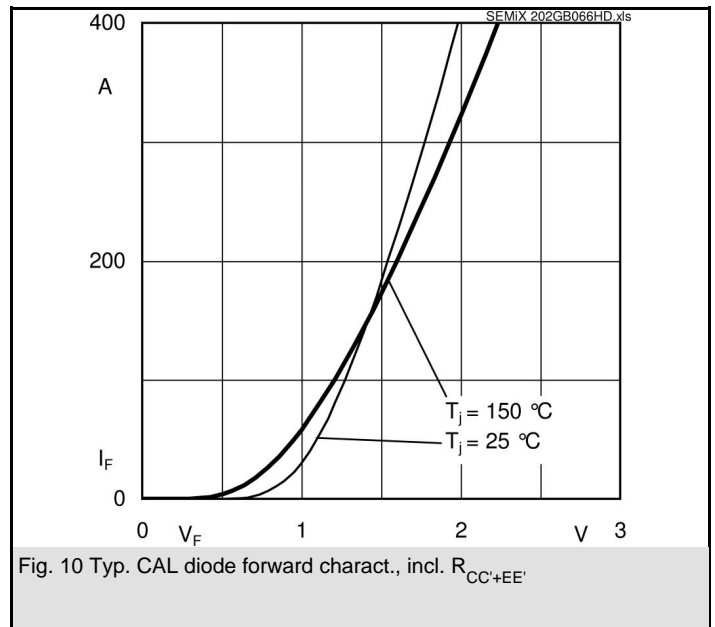
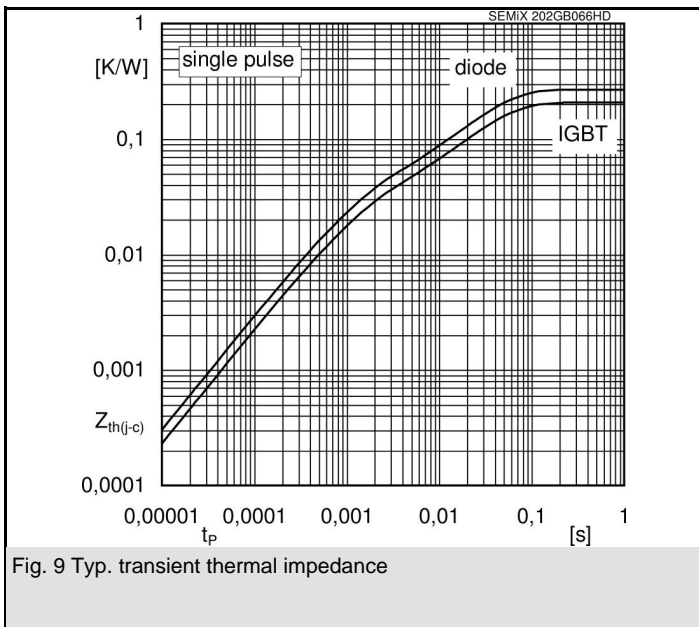
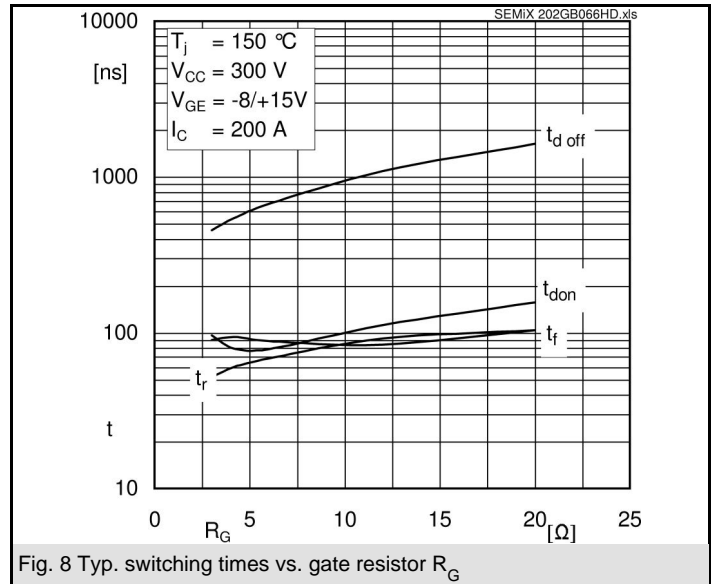
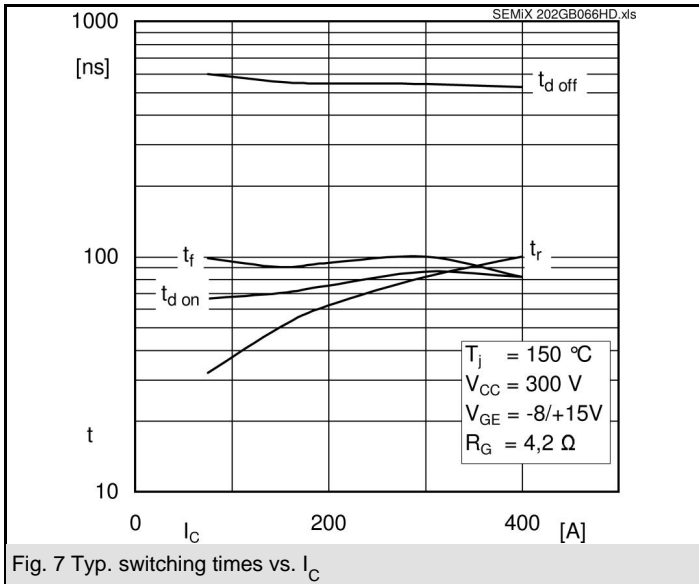

case: SEMiX 2s

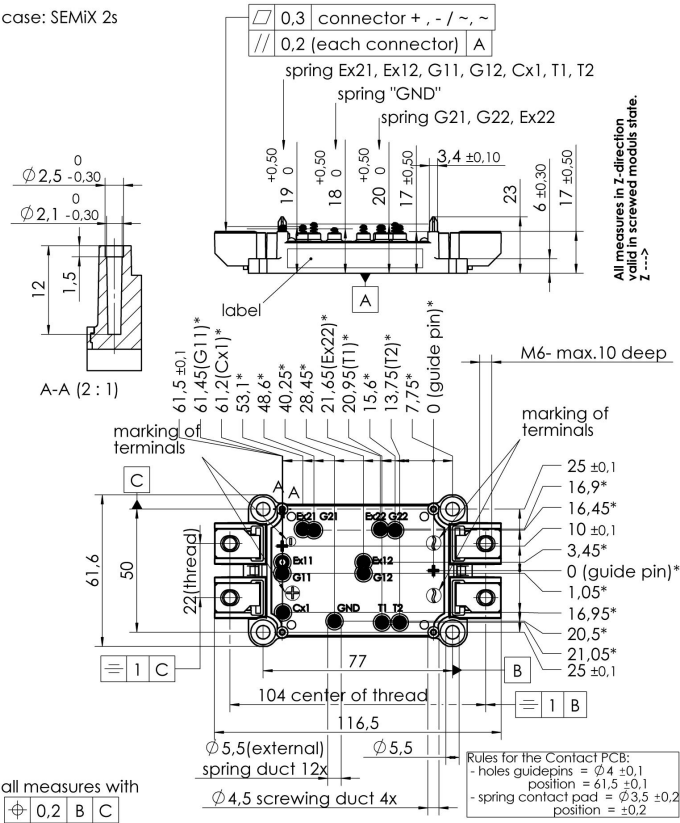

Case SEMiX 2s

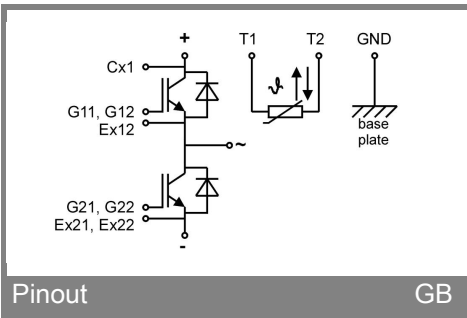

Pinout

GB