

R-11-055-X-XXX-X-XX

**Features**

- InGaAs/InP PIN Photodiode
- Sensitive receiver at 1310nm and 1550nm
- Low dark current
- Fast pulse response
- -40~85°C operating temperature
- Hermetically sealed 3-pin metal case

**Packaging**

- FC/ST/SC Receptacle packaged
- SM/MM fiber pigtailed with optional FC/ST/SC connector

**Application**

- RoHS compliant available

**Absolute Maximum Ratings (T<sub>c</sub>=25°C)**

Parameter	Symbol	Value	Unit
Supply Reverse Voltage	V <sub>R</sub>	20	V
Forward Current	I <sub>F</sub>	2	mA
Reverse Current	I <sub>R</sub>	1	mA
Operating Temperature	T <sub>opr</sub>	-40 ~ 85	°C
Storage Temperature	T <sub>stg</sub>	-40 ~ 85	°C

(All optical data refer to a coupled 9/125µm SM fiber, 50/125µm MM fiber and 62.5/125µm MM fiber)

**Optical and Electrical Characteristics (T<sub>c</sub>=25°C)**

Parameter	Symbol	Min	Typ	Max	Unit	Test Conditions
Active Area (Dia)		-	55	-	µm	-
Detection Range		1100	1310	1650	nm	-
Responsivity	R	0.8	0.85	-	A/W	V <sub>R</sub> =5V, λ=1310nm
Dark Current	I <sub>dark</sub>	-	-	0.7	nA	V <sub>R</sub> =5V
Capacitance	C	-	-	0.7	pF	V <sub>R</sub> =5V
Rise / Fall Time	T <sub>r</sub> / T <sub>f</sub>	-	-	0.3	ns	V <sub>R</sub> =5V, 10%~90%
Bandwidth	BW	3	-	-	GHz	V <sub>R</sub> =5V

**Note: 1.Pin assignment can be customized.**

**2.Specifications subject to change without notice.**

R-11-055-X-XXX-X-XX

Pin Assignment

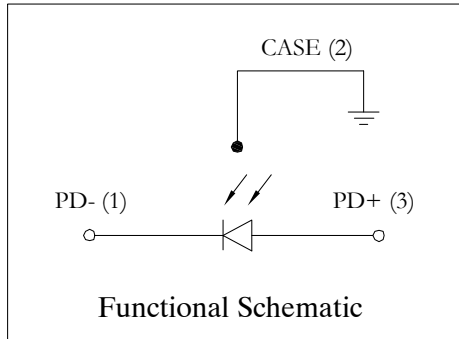

**Pin Assignment**

1~PD (-)  
 2~CASE  
 3~PD (+)

Packaging Dimension

Units in mm.

**PIN TIA Receiver Module-Receptacle**

Part Number : R-11-055-R-SXX-XX

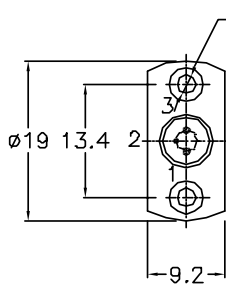

FC Receptacle  
 R-11-055-R-SFC-XX

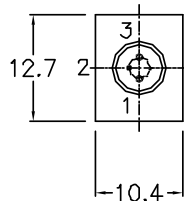
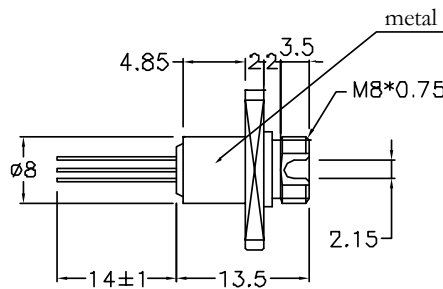

ST Receptacle  
 R-11-055-R-SST-XX

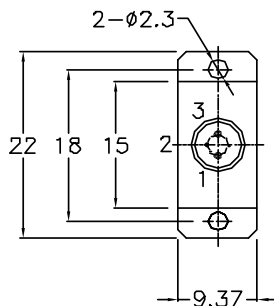
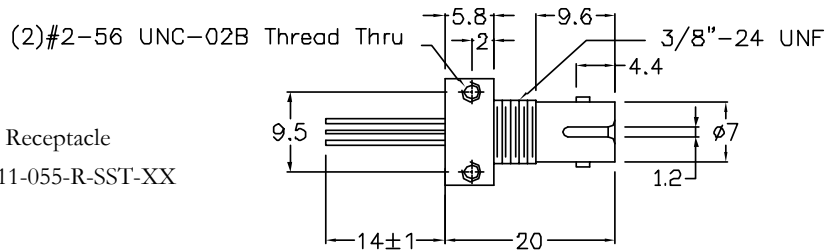

SC Receptacle  
 R-11-055-R-SSC-XX

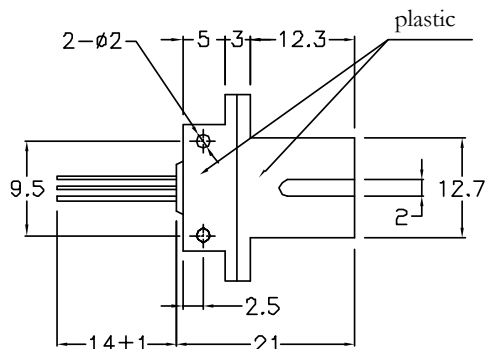

Packaging Dimension

Units in mm.

**PIN TIA Receiver Module-Pigtail**

Part Number : R-11-055-P-XXX-X-XX

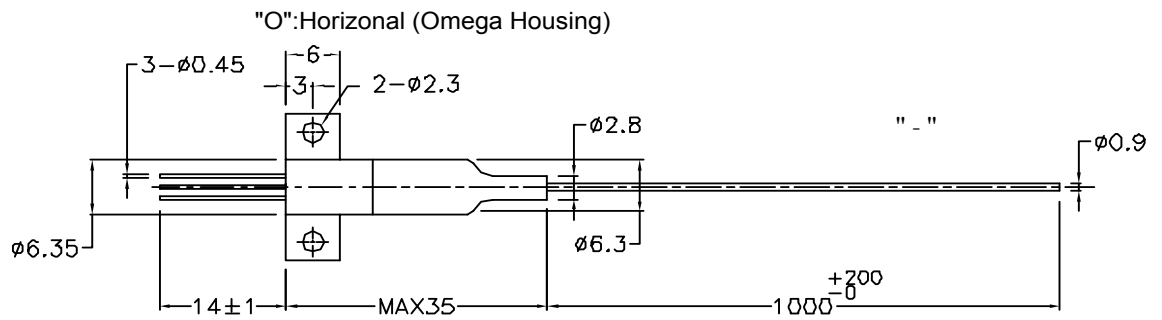
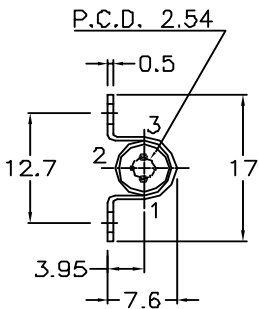
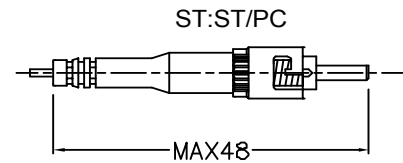
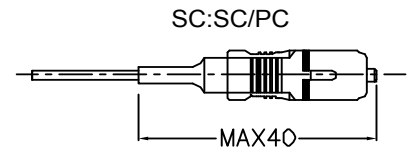
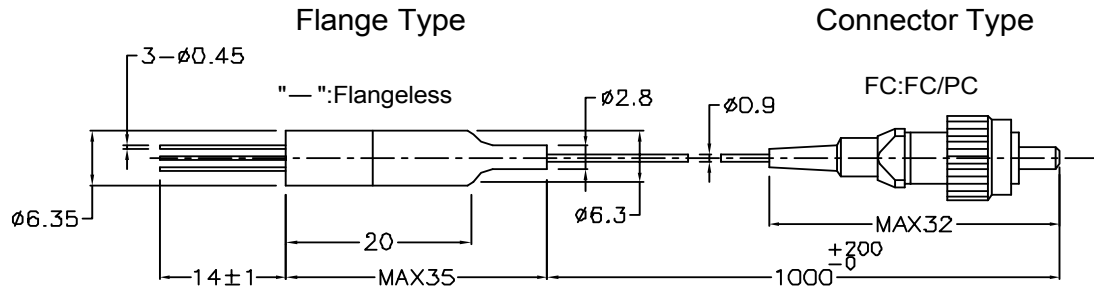
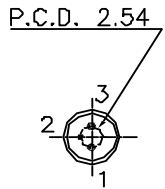

Ordering Information

R-11-075-X-XXX-X-XX

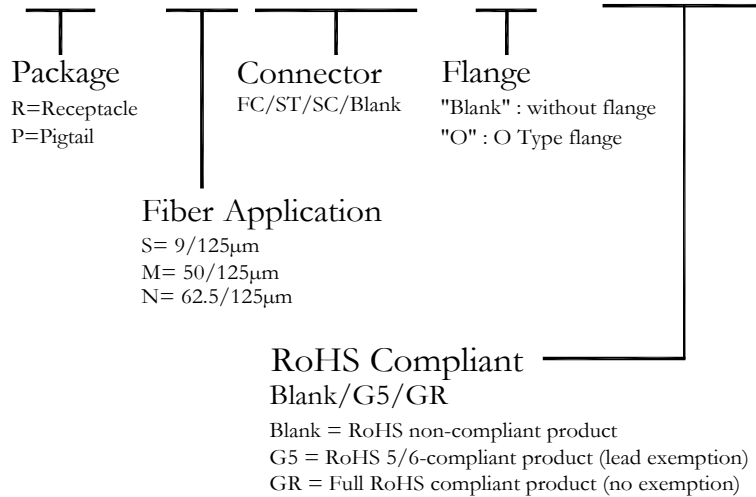

Warnings

Handling Precautions: This device is susceptible to damage as a result of electrostatic discharge (ESD). A static free environment is highly recommended. Follow guidelines according to proper ESD procedures.  
 Laser Safety: Radiation emitted by laser devices can be dangerous to human eyes. Avoid eye exposure to direct or indirect radiation.

Legal Notice

**IMPORTANT NOTICE!**  
 All information contained in this document is subject to change without notice, at Luminent's sole and absolute discretion. Luminent warrants performance of its products to current specifications only in accordance with the company's standard one-year warranty; however, specifications designated as "preliminary" are given to describe components only, and Luminent expressly disclaims any and all warranties for said products, including express, implied, and statutory warranties, warranties of merchantability, fitness for a particular purpose, and non-infringement of proprietary rights. Please refer to the company's Terms and Conditions of Sale for further warranty information.

Luminent assumes no liability for applications assistance, customer product design, software performance, or infringement of patents, services, or intellectual property described herein. No license, either express or implied, is granted under any patent right, copyright, or intellectual property right, and Luminent makes no representations or warranties that the product(s) described herein are free from patent, copyright, or intellectual property rights. Products described in this document are NOT intended for use in implantation or other life support applications where malfunction may result in injury or death to persons. Luminent customers using or selling products for use in such applications do so at their own risk and agree to fully defend and indemnify Luminent for any damages resulting from such use or sale.

THE INFORMATION CONTAINED IN THIS DOCUMENT IS PROVIDED ON AN "AS IS" BASIS. Customer agrees that Luminent is not liable for any actual, consequential, exemplary, or other damages arising directly or indirectly from any use of the information contained in this document. Customer must contact Luminent to obtain the latest version of this publication to verify, before placing any order, that the information contained herein is current.

© LuminentOIC, Inc. 2007  
 All rights reserved