

PRELIMINARY DATA SHEET



NEC's InGaAsP MQW-DFB LASER MODULE IN COAXIAL PACKAGE FOR 2.5 Gb/s, CWDM APPLICATIONS

NX8508 Series

FEATURES

- **INTERNAL OPTICAL ISOLATOR**
- **PEAK EMISSION WAVELENGTH**
 $\lambda_p = 1\,470$ to $1\,610$ nm (Based on CWDM)
- **OPTICAL OUTPUT POWER**
 $P_f = 2.0$ mW
- **OPERATING CASE TEMPERATURE RANGE**
 $T_c = -20$ to $+85^\circ\text{C}$
- **SIDE MODE SUPPRESSION RATIO**
SMSR = 40 dB
- **InGaAs MONITOR PIN-PD**
- **WITH SC-UPC CONNECTOR**
- **BASED ON TELCORDIA RELIABILITY**



DESCRIPTION

NEC'S NX8508 Series are 1 470 to 1 610 nm Multiple Quantum Well (MQW) structured Distributed Feed-Back (DFB) laser diode coaxial modules with an internal optical isolator.

These devices are ideal for 2.5 Gb/s CWDM application.

ELECTRO-OPTICAL CHARACTERISTICS ($T_c = -20$ to $+85^\circ\text{C}$, unless otherwise specified)

SYMBOLS	PART NUMBER		NX8508 SERIES		
	PARAMETER AND CONDITIONS	UNIT	MIN.	TYP.	MAX.
P_f	Optical Output Power from Fiber, CW, $T_c = 25^\circ\text{C}$, $I_f = I_{th} + 20$ mA	mW		2.0	
V_{op}	Operating Voltage, CW, $P_f = 2.0$ mW	V		1.1	1.6
I_{th}	Threshold Current, $T_c = 25^\circ\text{C}$	mA		10	20
					50
P_{th}	Threshold Output Power, $I_f = I_{th}$	μW			100
η_d	Differential Efficiency	$P_f = 2.0$ mW, $T_c = 25^\circ\text{C}$	W/A	0.07	0.1
		$P_f = 2.0$ mW		0.04	
$\Delta\eta_d$	Temperature Dependence of Differential Efficiency $\Delta\eta_d = 10 \log \frac{\eta_d (@ T_c^\circ\text{C})}{\eta_d (@ 25^\circ\text{C})}$	dB	-3.0	-1.6	
λ_p	Peak Emission Wavelength, CW, $P_f = 2.0$ mW, $T_c = 25^\circ\text{C}$	nm	$\lambda_p - 2$	$\lambda_p + 1$	$\lambda_p + 2$
$\Delta\lambda/\Delta T$	Temperature Dependence of Peak Emission Wavelength, CW	nm/ $^\circ\text{C}$	0.08	0.10	0.12
SMSR	Side Mode Suppression Ratio, $P_f = 2.0$ mW	dB	30	40	
t_r	Rise Time, 20-80%, $P_f = 2.0$ mW	ps			100

Continued on next page

ELECTRO-OPTICAL CHARACTERISTICS (T_C = -25 to +85°C, unless otherwise specified)

SYMBOLS	PART NUMBER		NX8508 SERIES			
	PARAMETER AND CONDITIONS		UNIT	MIN.	TYP.	MAX.
t _f	Fall Time, 80-20%, P _r = 2.0 mW		ps			150
I _m	Monitor Current, V _R = 1.5 V, P _r = 1.0 mW		μA	100	500	1 000
I _d	Monitor Dark Current	V _R = 1.5 V, T _C = 25°C	nA		0.1	10
		V _R = 1.5 V			10	100
γ	Tracking Error *2, I _m = const.		dB	-1.0		1.0

*1 Available Available for CWDM Wavelengths based on ITU-T recommendations

λ_p = 1 470, 1 490, 1 510, 1 530, 1 550, 1 570, 1 590, 1 610 nm

Please refer to **Table A**.

Table A: CWDM wavelength code (@ T_C = 25°C)

WAVELENGTH CODE	MIN. (nm)	TYP. (nm)	MAX. (nm)
47	1 468	1 470	1 472
49	1 488	1 490	1 492
51	1 508	1 510	1 512
53	1 528	1 530	1 532
55	1 548	1 550	1 552
57	1 568	1 570	1 572
59	1 588	1 590	1 592
61	1 608	1 610	1 612

*2 Tracking Error: γ

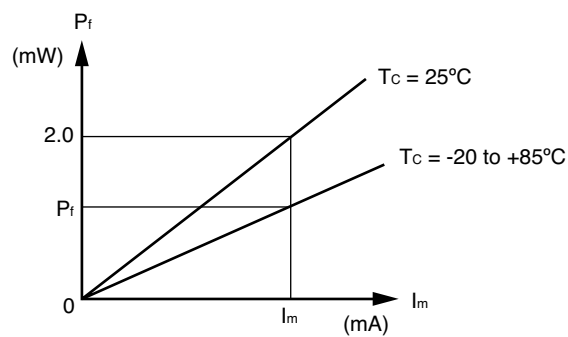

$$\gamma = \left| 10 \log \frac{P_f}{2.0} \right| \text{ [dB]}$$

ABSOLUTE MAXIMUM RATINGS¹

SYMBOL	PARAMETER	UNIT	RATINGS
P _f	Optical Output Power from Fiber	mW	5
I _F	Forward Current of LD	mA	150
V _R	Reverse Voltage of LD	V	2.0
I _F	Forward Current of PD	mA	2.0
V _R	Reverse Voltage of PD	V	15
T _c	Operating Case Temperature	°C	-20 to +85
T _{stg}	Storage Temperature	°C	-40 to +85

PACKAGE DIMENSIONS (Units in mm)

NX8508BMxx^{*1}-CC

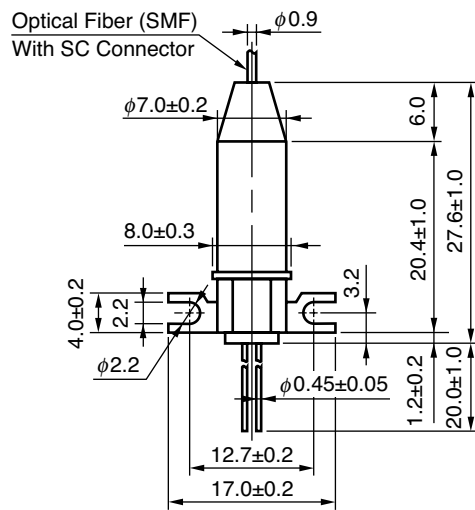

PIN CONNECTIONS

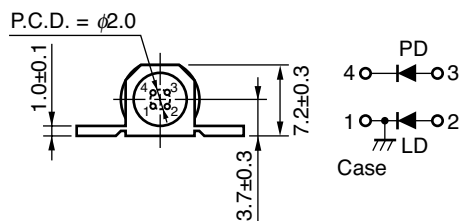

NX8508CGxx^{*1}-CC

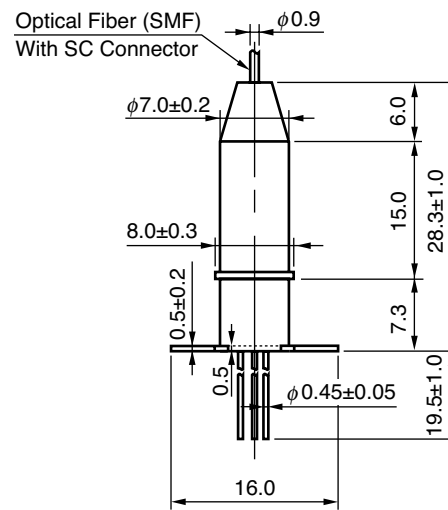

PIN CONNECTIONS

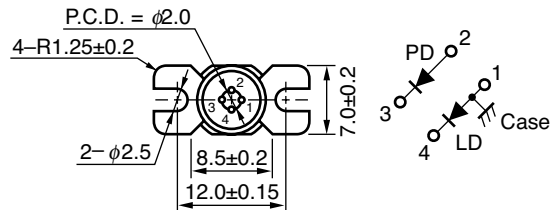

^{*1} Please refer to ORDERING INFORMATION.

OPTICAL FIBER CHARACTERISTICS

PARAMETER	SPECIFICATION	UNIT
Mode Field Diameter	9.5±1	μm
Cladding Diameter	125±2	μm
Maximum Cladding Noncircularity	2	%
Maximum Core/Cladding Concentricity	1.6	%
Outer Diameter	0.9±0.1	mm
Cut-off Wavelength	1 100 to 1 270	nm
Minimum Fiber Bending Radius	30	mm
Fiber Length	1 000±100	mm
Flammability	UL1581 VW-1	

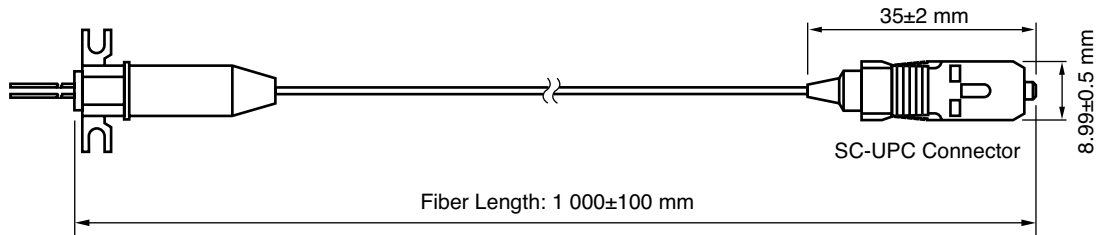

ORDERING INFORMATION

PART NUMBER	FLANGE TYPE	AVAILABLE CONNECTOR
NX8508BMxx-CC-AZ*	Flat Mount Flange	With SC-UPC
NX8508CGxx-CC-AZ*	Vertical Mount Flange	Connector

*NOTE:

Please refer to the last page of this data sheet, "Compliance with EU Directives" for Pb-Free RoHS Compliance Information.

NX8508□□xx-CC

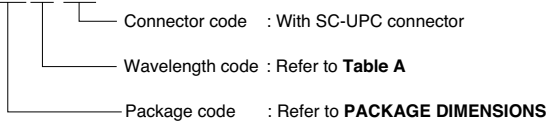

Life Support Applications

These NEC products are not intended for use in life support devices, appliances, or systems where the malfunction of these products can reasonably be expected to result in personal injury. The customers of CEL using or selling these products for use in such applications do so at their own risk and agree to fully indemnify CEL for all damages resulting from such improper use or sale.

CEL California Eastern Laboratories, Your source for NEC RF, Microwave, Optoelectronic, and Fiber Optic Semiconductor Devices.
4590 Patrick Henry Drive • Santa Clara, CA 95054-1817 • (408) 988-3500 • FAX (408) 988-0279 • www.cel.com

DATA SUBJECT TO CHANGE WITHOUT NOTICE

05/03/2004

Subject: Compliance with EU Directives

CEL certifies, to its knowledge, that semiconductor and laser products detailed below are compliant with the requirements of European Union (EU) Directive 2002/95/EC Restriction on Use of Hazardous Substances in electrical and electronic equipment (RoHS) and the requirements of EU Directive 2003/11/EC Restriction on Penta and Octa BDE.

CEL Pb-free products have the same base part number with a suffix added. The suffix –A indicates that the device is Pb-free. The –AZ suffix is used to designate devices containing Pb which are exempted from the requirement of RoHS directive (*). In all cases the devices have Pb-free terminals. All devices with these suffixes meet the requirements of the RoHS directive.

This status is based on CEL’s understanding of the EU Directives and knowledge of the materials that go into its products as of the date of disclosure of this information.

Restricted Substance per RoHS	Concentration Limit per RoHS (values are not yet fixed)	Concentration contained in CEL devices	
		-A	-AZ
Lead (Pb)	< 1000 PPM	Not Detected	(*)
Mercury	< 1000 PPM	Not Detected	
Cadmium	< 100 PPM	Not Detected	
Hexavalent Chromium	< 1000 PPM	Not Detected	
PBB	< 1000 PPM	Not Detected	
PBDE	< 1000 PPM	Not Detected	

If you should have any additional questions regarding our devices and compliance to environmental standards, please do not hesitate to contact your local representative.

Important Information and Disclaimer: Information provided by CEL on its website or in other communications concerning the substance content of its products represents knowledge and belief as of the date that it is provided. CEL bases its knowledge and belief on information provided by third parties and makes no representation or warranty as to the accuracy of such information. Efforts are underway to better integrate information from third parties. CEL has taken and continues to take reasonable steps to provide representative and accurate information but may not have conducted destructive testing or chemical analysis on incoming materials and chemicals. CEL and CEL suppliers consider certain information to be proprietary, and thus CAS numbers and other limited information may not be available for release.

In no event shall CEL’s liability arising out of such information exceed the total purchase price of the CEL part(s) at issue sold by CEL to customer on an annual basis.

See CEL Terms and Conditions for additional clarification of warranties and liability.