

Part Number	Description
DRL48R35	35A 510 Vac Output
DRL48D35-21	35A 480 Vac Output
DRL48D35	35A 510 Vac Output
DRL48A35-22	35A 510 Vac Output
DRL48A35	35A 510 Vac Output

Part Number Explanation

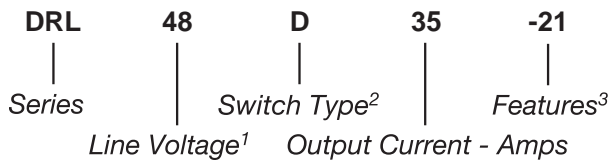

NOTES

- 1) Line Voltage (nominal): 48 = 480 Vac
- 2) Switch Type: D = Zero-cross turn-on; A = Zero-cross, AC control; R = Random turn-on
- 3) Features: -21 = Self turn-on suppression; -22 = 24 Vac control

MECHANICAL SPECIFICATION

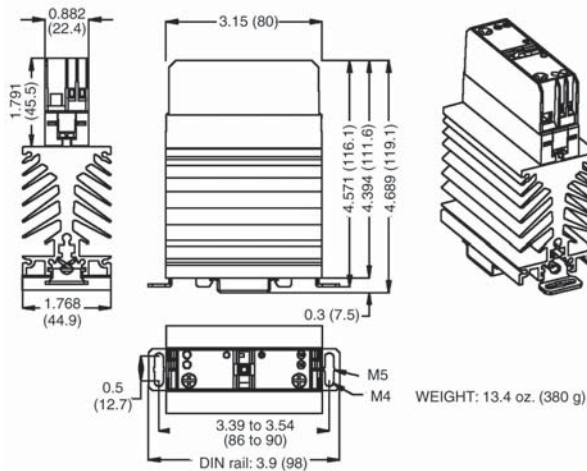

Figure 1 — DRL relay; dimensions in inches (mm)



FEATURES/BENEFITS

- Mounting and dismounting on DIN rail without any tool or directly mountable on panel
- Zero-cross and random models; thyristors output
- Large control range
- Green control LED
- Very high immunity
- Low leakage current
- Internal transient suppression

DESCRIPTION

The Series DRL single-phase DIN-rail relays are designed for all types of loads. The relays utilize optical isolation to protect the control from load transients. DRL relays have an integral heat sink, and can be mounted and dismounted onto a DIN rail without any tools. The relays may also be panel mounted. All relays offer a green control LED and transient suppression.

APPLICATIONS

- Heating control
- Motor control
- Industrial and process control

APPROVALS

Series DRL relays are pending UL recognition.

CONTROL CHARACTERISTIC

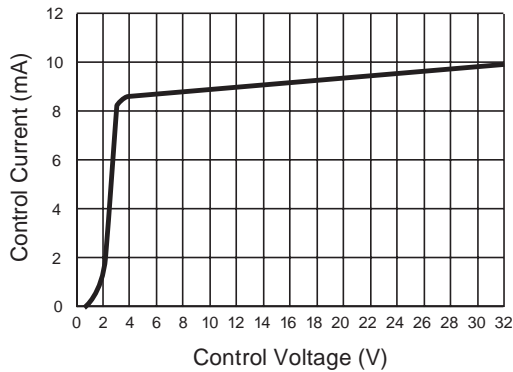

Figure 2a — DR38R and DR48D relays

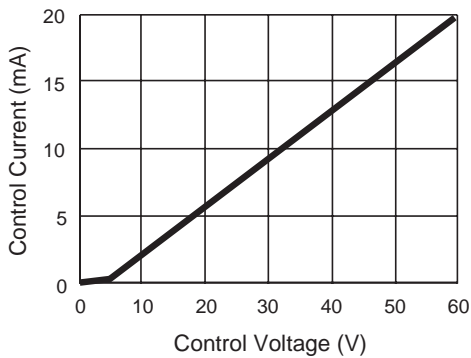

Figure 2b — DRL48A35-22 relay

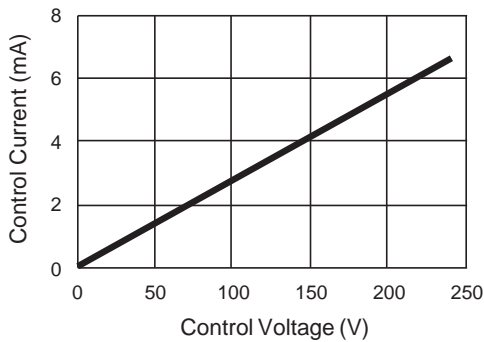

Figure 2c — DRL48A35 relay

INPUT (CONTROL) SPECIFICATION

	Min	Max	Units
Control Range			
DRL48R35	3.5	32	Vdc
DRL48D35-21	3	32	Vdc
DRL48D35	3.5	32	Vdc
DRL48A35-22	17	60	Vac/Vdc
DRL48A35	150	240	Vac/Vdc

Control Current Range			
DRL48R35		10	mAdc
DRL48D		10	mAdc
DRL48A35-22	3	20	mA
DRL48A35	3	7	mA

Must Turn-off Voltage			
DRL48R35	2		V
DRL48D35-21	1		V
DRL48D35	2		V
DRL48A35-22	4		V
DRL48A35	15		V

Reverse Voltage (DC Control)	32	V
Clamping Voltage (DC Control)	42	V
Input LED	Green	

TYPICAL APPLICATION

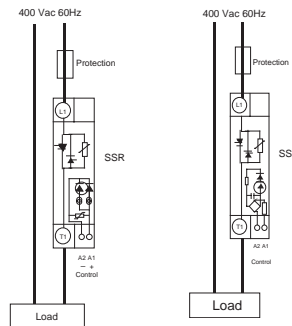

Figure 3 — DRL relay DC control (left) and DRL relay AC control (right)

OUTPUT (LOAD) SPECIFICATION

	Min	Max	Unit
Operating Range	24	510	Vrms
Peak Voltage		1200	Vpeak
Clamping Voltage			
-21 feature (On voltage, typical)		950	V
All others (@1mA)		820	V

Zero-Cross Window (Typical)

Model	Min	Max	Unit
DRL48R35		Random	
DRL48D35-21		±10	V
DRL48D35		±20	V
DRL48A		±20	V

Non-Repetitive Surge Current

(See Figure 5) 550 A

On-State Voltage Drop (Typical) 0.9 V

Output Power Dissipation (Typical) $0.81 \times I_e + 0.08 \times I_e^2$

Thermal Resistance (Junction to Air) 2.6 °C/W

Off-State Leakage Current (60Hz) 1 mA

Turn-On Time (60Hz)

DRL48R35	0.1	ms
DRL48D	8.3	ms
DRL48A	24.9	ms

Turn-Off Time (60Hz)

DRL48R35	8.3	ms
DRL48D	8.3	ms
DRL48A	24.9	ms

Operating Frequency Range	0.1	440	Hz
Off-State dv/dt		500	V/μs
I ² t for match fusing (<8.3ms)		1500	A ² S

ENVIRONMENTAL SPECIFICATION

	Min	Max	Unit
Storage Temperature	-30	100	°C
Operating Temperature	-30	80	°C
Input-Output Isolation	4000		Vrms
Output-Case Isolation	4000		Vrms
Insulation Resistance	100		MΩ
Rated Impulse Voltage	4000		V

THERMAL CHARACTERISTICS

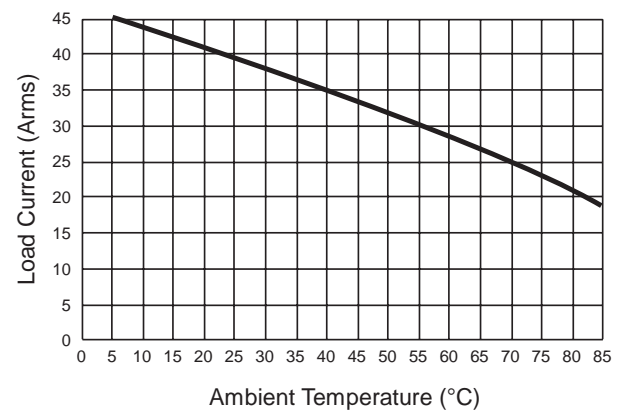

Figure 4 — DRL relays

SURGE CURRENTS

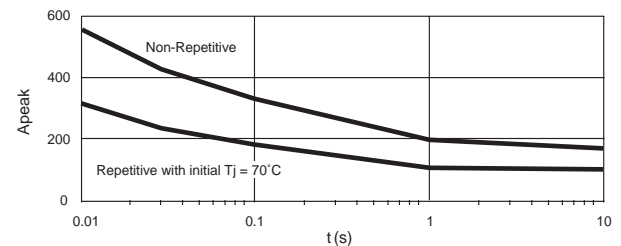

Figure 5 — DRL relays

DIN-RAIL MOUNTING

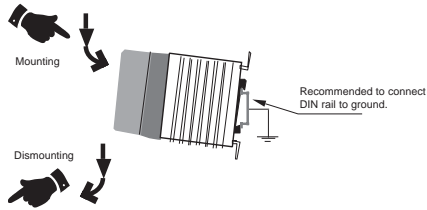

Figure 6 — DRL relays

PANEL MOUNTING

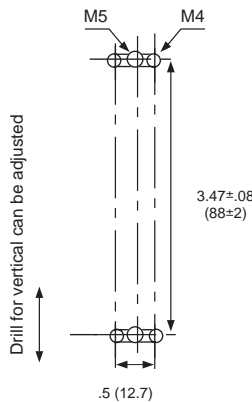

Figure 7 — DRL relays

CONNECTIONS



wires (mm ²)	torques	screwdriver
control 1 x (0.75-->2.5) L = 6mm	0.4N.m (0.6N.m max)	3.5 x 0.5mm
Power 1 x (1.5-->16) 1 x (1.5-->10) L = 10mm	1.2N.m (1.8N.m max)	Pozidriv2/ 0.8 x 5.5 (1 x 6)

Figure 8 — DRL relays

NOTES:

1. Connections: For output terminals, the wire cross-sections must be adapted to the load current and to the overcurrent protection device characteristics. The relay rated voltage must be adapted to the mains rated voltage. These relays use screw clamp connections.

2. Mounting: Only in vertical position. Protect heat-sensitive materials as well as people from contact with the heat sink. For non-vertical mounting, the load current must be derated by 50%. The SSR requires air convection. Lack of air convection produces an abnormal heating. Keep a distance between the upper SSR and the lower SSR (see figure on the right). In case of zero space between two SSRs, reduce the load current. It's suggested to maintain the heat sink temperature under 90°C. Forced cooling significantly improves the thermal performances.

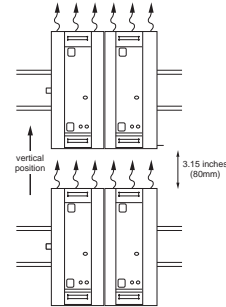

3. Typical application loads: The DRL relay may handle motor and resistive loads. For different loads, check the inrush current at turn-ON and possible overvoltages at turn-OFF or contact the factory.

- Incandescent lamps — Inrush current is generally 10 times the nominal current for 10ms.
- Electric discharge lamp — These loads often have overcurrent at turn-ON and overvoltage at turn-OFF. Use 480Vac SSR on 240Vac mains.
- Transformer loads — Very high inrush current, up to 100 times the nominal current.
- Capacitive loads — Very high current at turn-ON and overvoltage at turn-OFF. Use only zero-cross models.

4. Protection: To protect the SSR against a short-circuit of the load, use a fuse with a I²t value = 1/2 I²t value.

5. EMC:

Immunity: Immunity levels of the DRL comply with EN61000-4-4 &5.

Emission: The system integrator must ensure that systems containing SSRs comply with the requirements of any rules and regulations applicable at the system level. The very low zero-cross voltage (<20V) improves the conducted emission level in comparison with most SSRs with zero-cross voltage higher than 50V.

6. All electrical parameters specified at 25°C unless otherwise noted.

