

SMTC1-600F



Fast Turn-off Thyristor



Type	V_{RSM}	V_{RRM} , V_{DRM}
SMTC1-600F-6	700	600
SMTC1-600F-8	900	800
SMTC1-600F-10	1100	1000
SMTC1-600F-12	1300	1200
SMTC1-600F-14	1500	1400
SMTC1-600F-16	1700	1600

Type	I_{TAVM} $T_c=55^\circ\text{C}$	I_{TRMS}	I_{TSM}	$(di/dt)_{cr}$	$(dv/dt)_{cr}$	V_{TM}	I_{TM}	V_{TO}	r_T	V_{GT}	I_{GT}	T_{VJM}	R_{thJC}	F
	A	kA	kA	A/ μs	V/ μs	V	kA	V	$m\Omega$	V	mA	$^\circ\text{C}$	K/W	kN
SMTC1-600F	600	1.1	6.4	300	500-1000	2.7	1.8	1.20	0.42	2.5	250	115	0.032	20

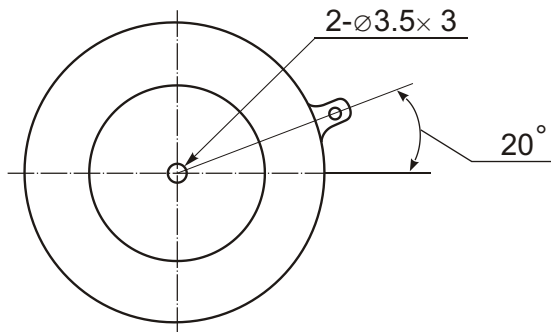

Type	t_q ($T_c=105^\circ\text{C}$)
	μs
SMTC1-600F-xx-OED7	16
SMTC1-600F-xx-NED7	20
SMTC1-600F-xx-MED7	25
SMTC1-600F-xx-LED7	30
SMTC1-600F-xx-KED7	40

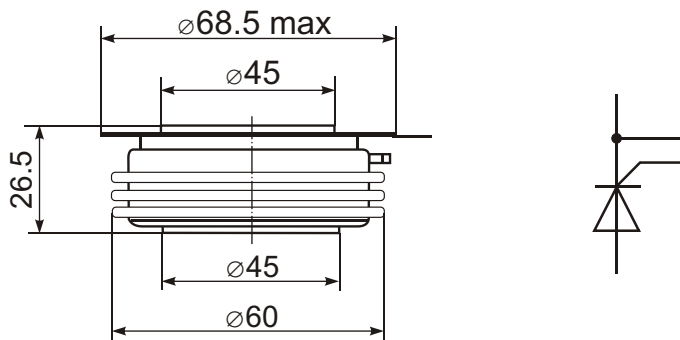

Features:

- Hermetic metal case with ceramic insulator
- Capsule packages for double sided cooling
- International standard case
- Amplifying gates

Typical Applications:

- DC motor control
- AC motor soft starter
- Controlled rectifiers
- AC controllers