

# SMTC1-400

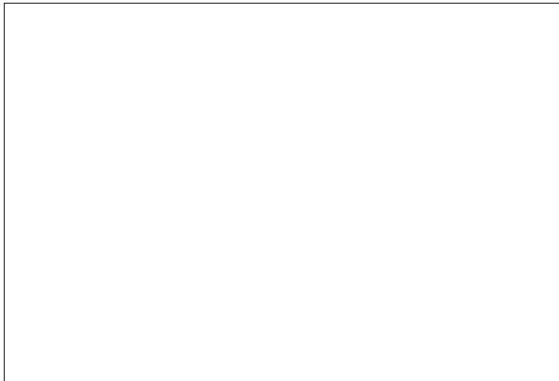

## Phase Control Thyristor



Type	$V_{RSM}$	$V_{RRM}$ , $V_{DRM}$
SMTC1-400-6	700	600
SMTC1-400-8	900	800
SMTC1-400-10	1100	1000
SMTC1-400-12	1300	1200
SMTC1-400-14	1500	1400
SMTC1-400-16	1700	1600

Type	$I_{TAVM}$ $T_c=55^\circ\text{C}$	$I_{TRMS}$	$I_{TSM}$	$(di/dt)_{cr}$	$(dv/dt)_{cr}$	$V_{TM}$	$I_{TM}$	$V_{TO}$	$r_T$	$t_q$	$V_{GT}$	$I_{GT}$	$T_{VJM}$	$R_{thJC}$	F
	A	A	kA	A/ $\mu\text{s}$	V/ $\mu\text{s}$	V	kA	V	$m\Omega$	$\mu\text{s}$	V	mA	$^\circ\text{C}$	K/W	kN
SMTC1-400	400	710	4.0	200	1000	1.85	1.2	1.05	0.72	350	2.5	250	125	0.04	20

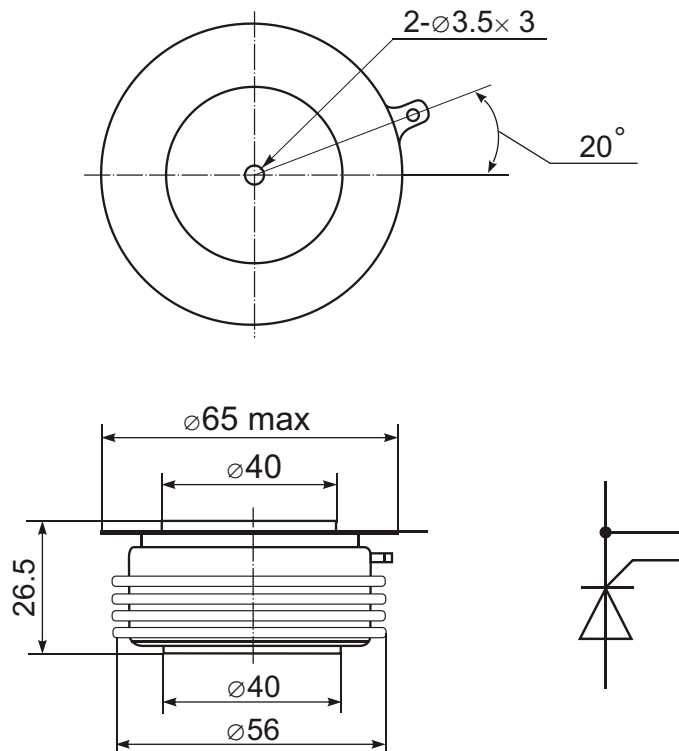

### Features:

- Hermetic metal case with ceramic insulator
- Capsule packages for double sided cooling
- International standard case
- Amplifying gates

### Typical Applications:

- DC motor control
- AC motor soft starter
- Controlled rectifiers
- AC controllers