

1.5-6.0 GHz GaAs MMIC Packaged Driver Amplifier

January 2008 - Rev 28-Jan-08

Features

- ✕ 13 dB Gain
- ✕ 14 dBm P1dB
- ✕ 3x3 QFN Package
- ✕ Single Positive Supply
- ✕ 5-8 V, 35 mA Self Bias
- ✕ RF Choke Inductors Integrated On-Chip
- ✕ RoHS Compliant

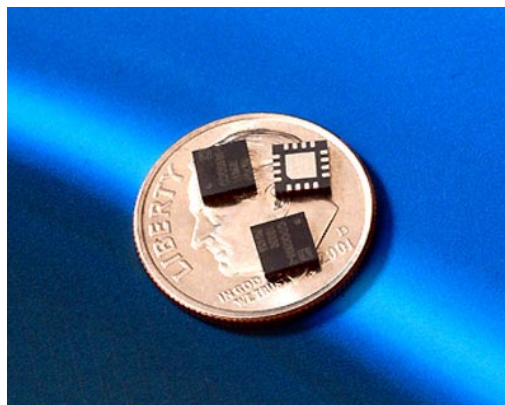

Circuit Description

Mimix Broadband's 2 stage 1.5 to 6.0 GHz driver amplifier is packaged in an RoHS compliant surface mount 3x3 QFN package. The device is a self-biased, single supply design with 13 dB gain and 14 dBm P1dB. This MMIC uses Mimix Broadband's 0.5um MESFET process. The device is fully matched, and RF choke inductors are integrated on-chip, so there is no need for external matching components, and it can be directly cascaded. Care must be taken to isolate the input and output from external DC voltages.

Absolute Maximum Ratings

Supply Voltage	+11 V
RF Input Power	+20 dBm
Storage Temperature (Tstg)	-55 °C to +125 °C
Junction Temperature	175 °C
Operating Temperature	-40 °C to +85°C
ΘJc	60 °C/W

Operating this device beyond any of these parameters may cause permanent damage.

Electrical Characteristics (T=25°C, 8V)

Parameter	Units	Min.	Typ.	Max.	Min.	Typ.	Max.
Frequency Range (f)	GHz	1.5	-	6	6.1	-	12
Gain (S21)	dB	-	13	-	-	8	-
Input Return Loss (S11)	dB	-	-12	-	-	-5	-
Output P1dB	dBm	8	14	-	-	14	-
Output IP3	dBm	20	24	-	-	24	-
Current (Id)	mA	-	35	62	-	35	62
Output Return Loss (S22)	dB	-	-10	-	-	-5	-
Noise Figure (NF)	dB	-	6	-	-	6	-

Typical Parameters (8V, 35 mA)

Parameter	Typical					
	2	4	6	8	10	12
Frequency (GHz)	2	4	6	8	10	12
Gain (dB)	13	13	11	8	7	6
IP Return Loss (dB)	-15	-12	-13	-8	-4	-6
Op Return Loss (dB)	-14	-13	-10	-6	-5	-10
P1dB (dBm)	14	14	14	15	15	14
OIP3 (dBm)	24	24	24	26	26	24
Noise Figure (dB)	6	6	6	6	6	6

1.5-6.0 GHz GaAs MMIC Packaged Driver Amplifier

Driver Amplifier Measurements

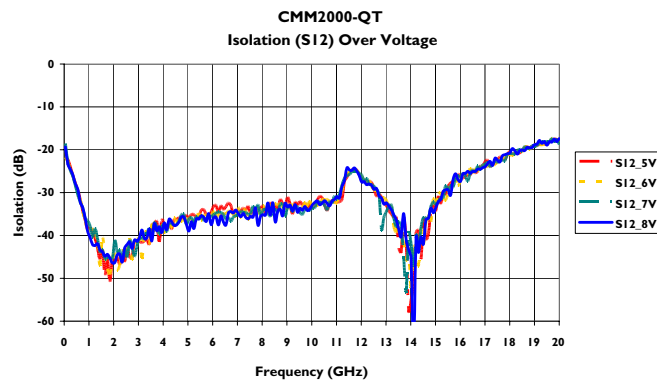
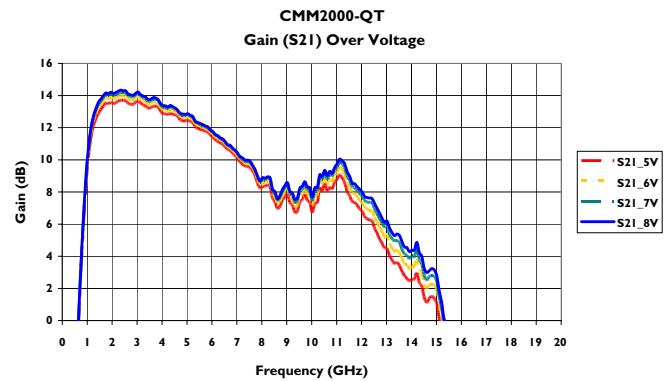
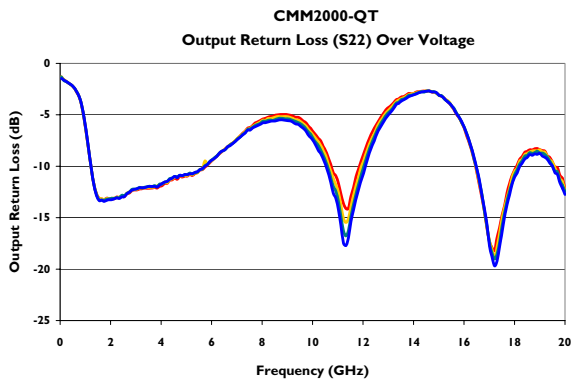
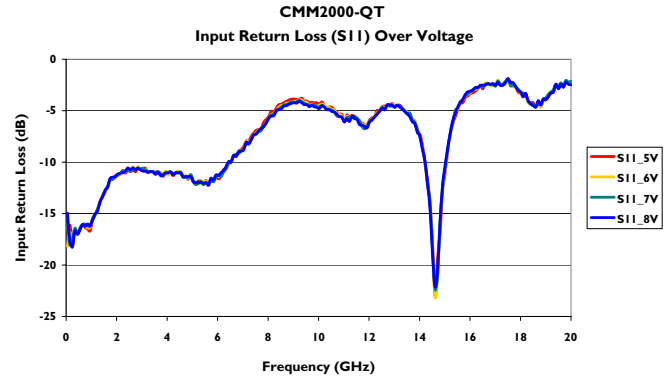
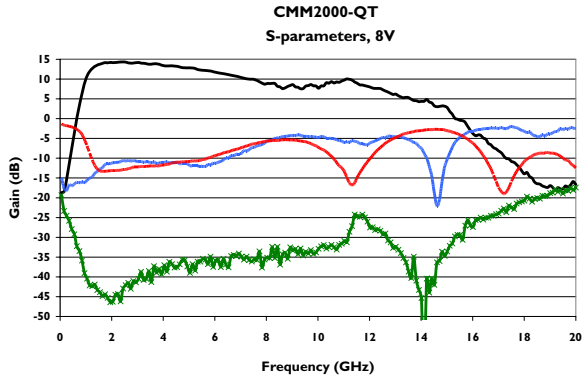

1.5-6.0 GHz GaAs MMIC Packaged Driver Amplifier



January 2008 - Rev 28-Jan-08

CMM2000-QT
RoHS

Driver Amplifier Measurements (cont.)

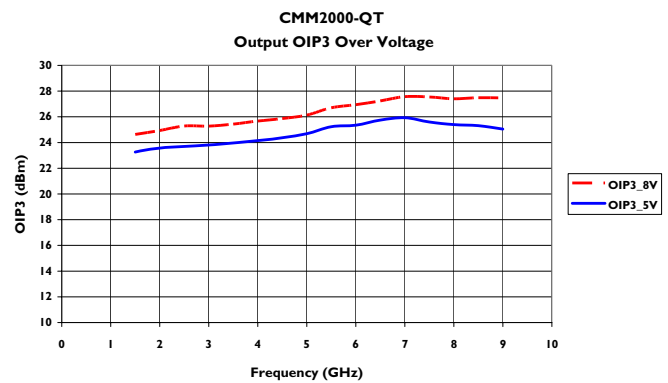
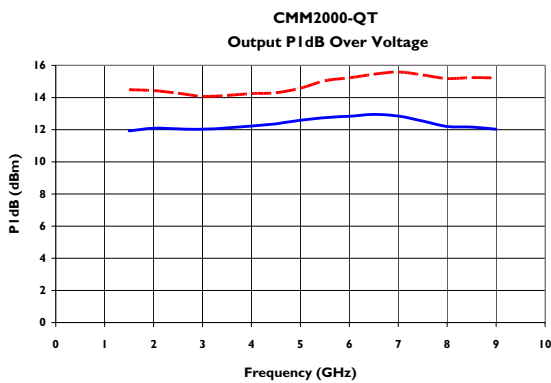
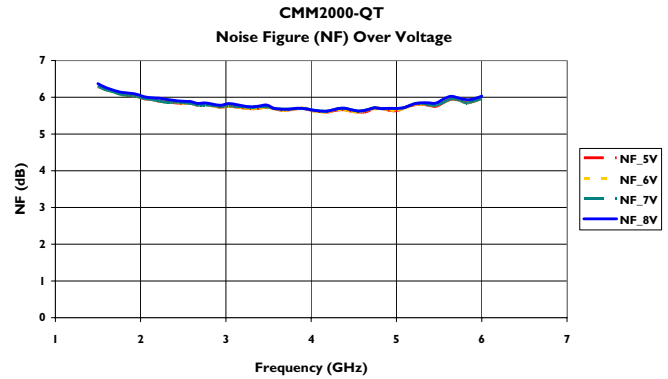
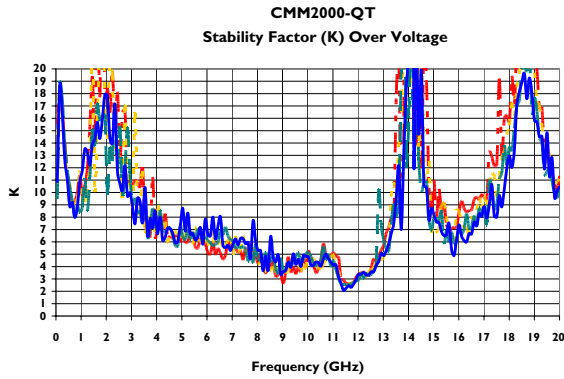

1.5-6.0 GHz GaAs MMIC Packaged Driver Amplifier



January 2008 - Rev 28-Jan-08

CMM2000-QT
RoHS

Driver Amplifier Measurements (cont.)

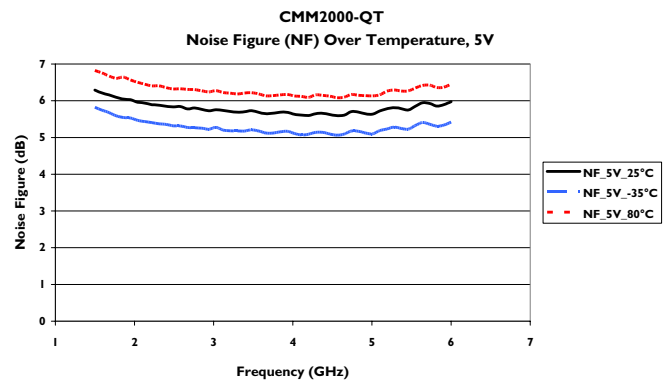
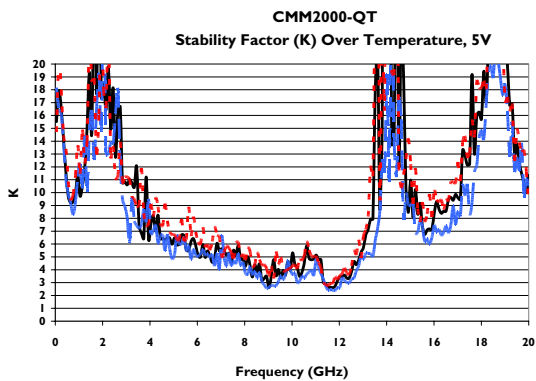
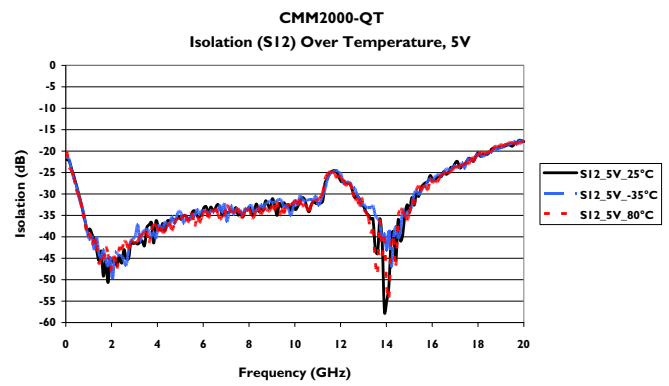
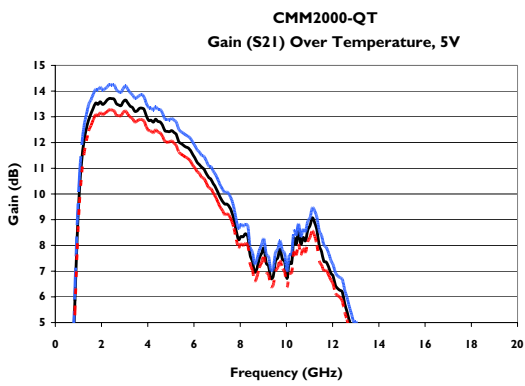
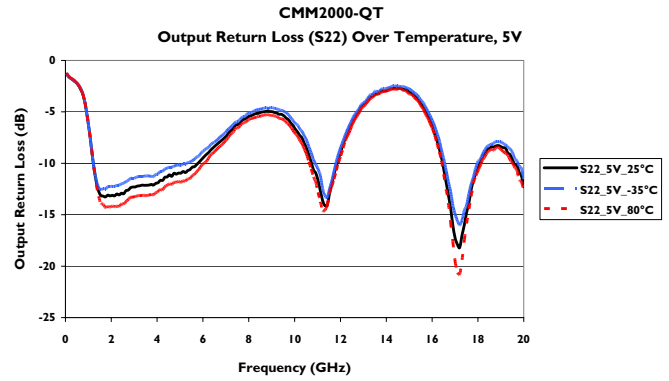
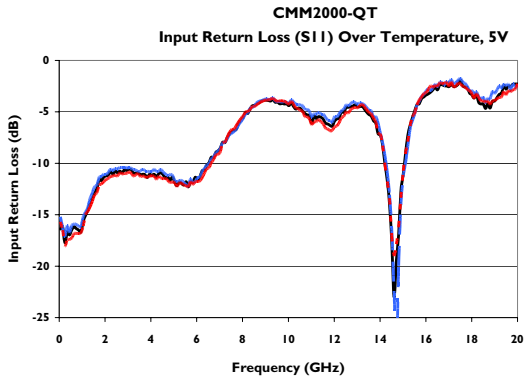

1.5-6.0 GHz GaAs MMIC Packaged Driver Amplifier



January 2008 - Rev 28-Jan-08

CMM2000-QT
RoHS

Driver Amplifier Measurements (cont.)

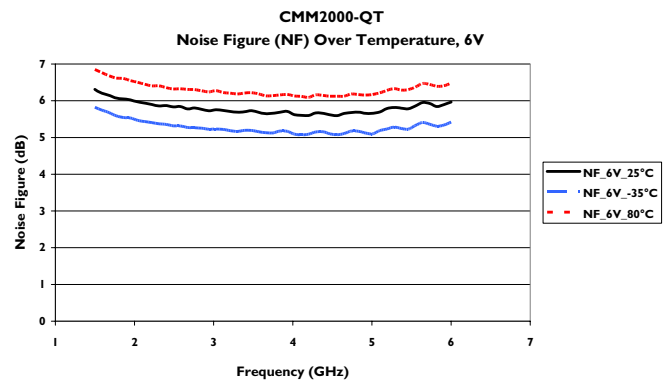
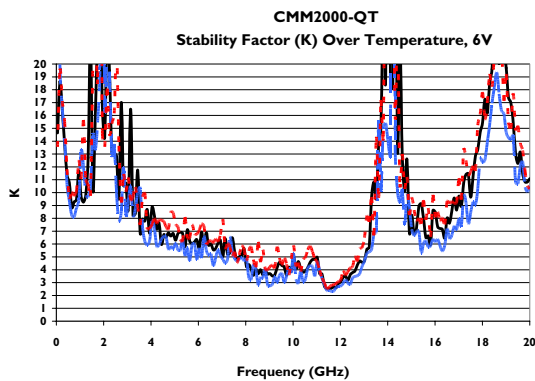
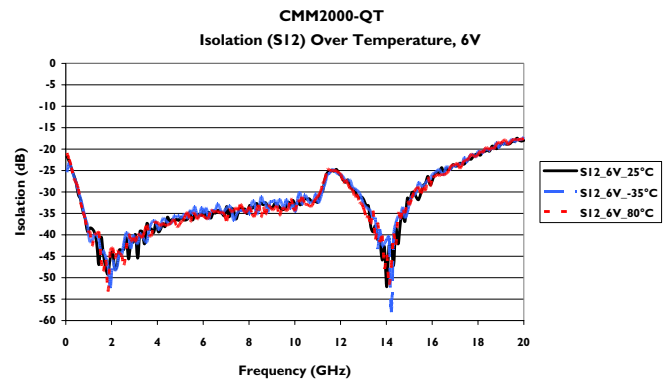
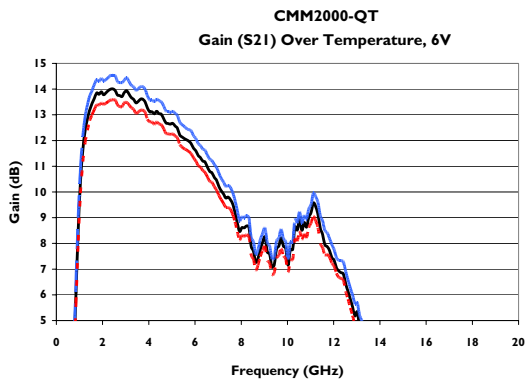
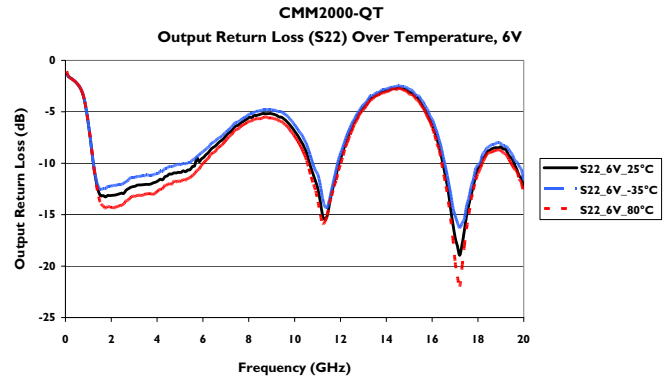
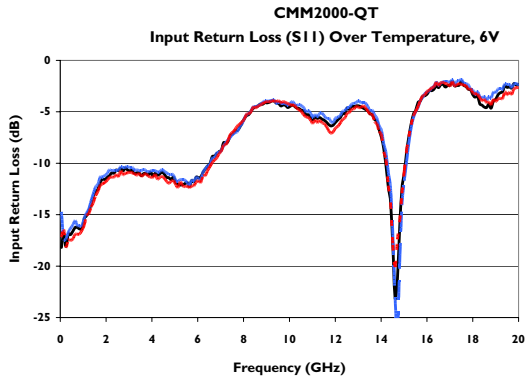

1.5-6.0 GHz GaAs MMIC Packaged Driver Amplifier



January 2008 - Rev 28-Jan-08

CMM2000-QT
RoHS

Driver Amplifier Measurements (cont.)

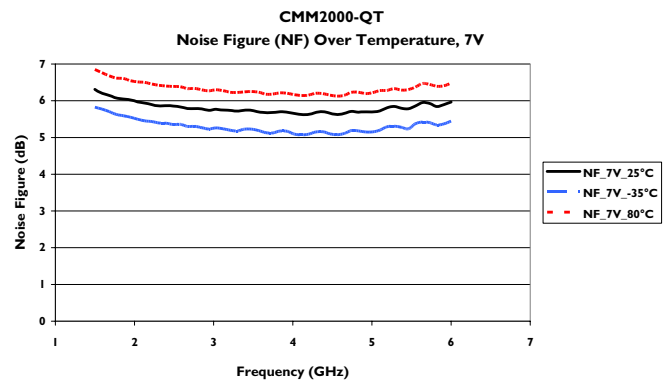
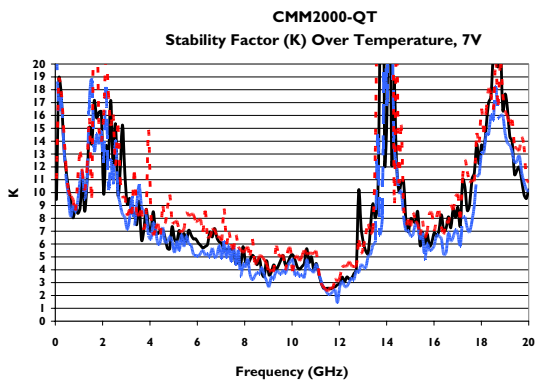
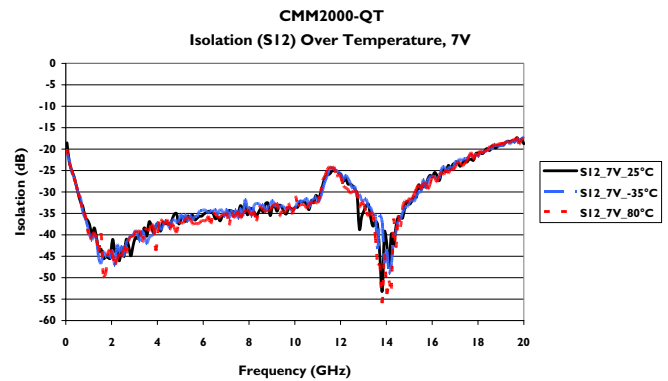
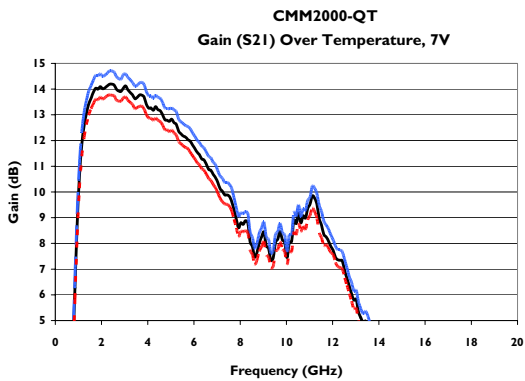
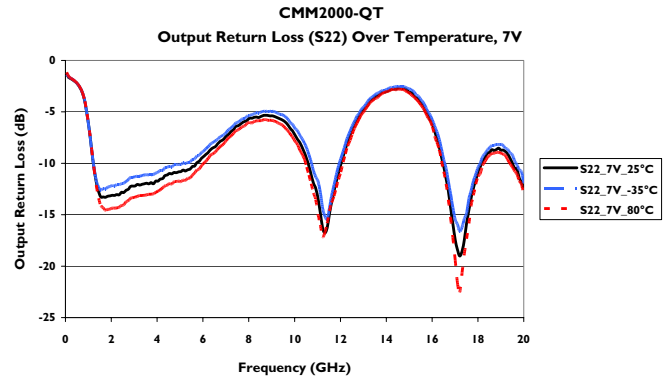
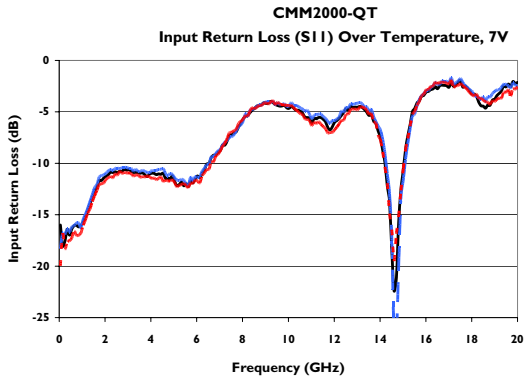

1.5-6.0 GHz GaAs MMIC Packaged Driver Amplifier



January 2008 - Rev 28-Jan-08

CMM2000-QT
RoHS

Driver Amplifier Measurements (cont.)

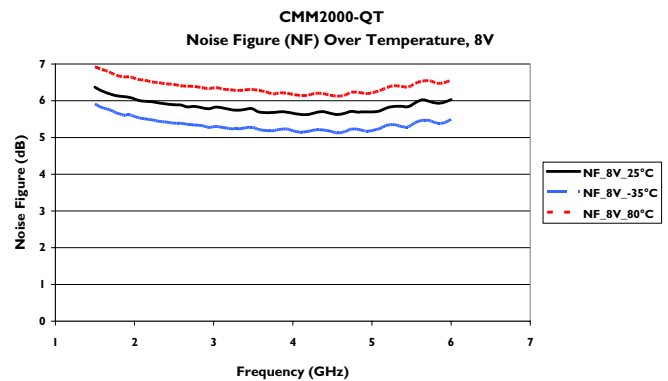
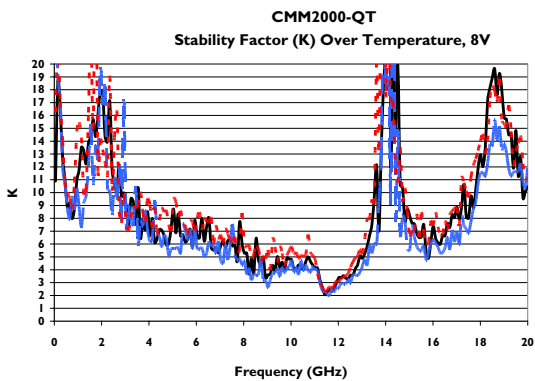
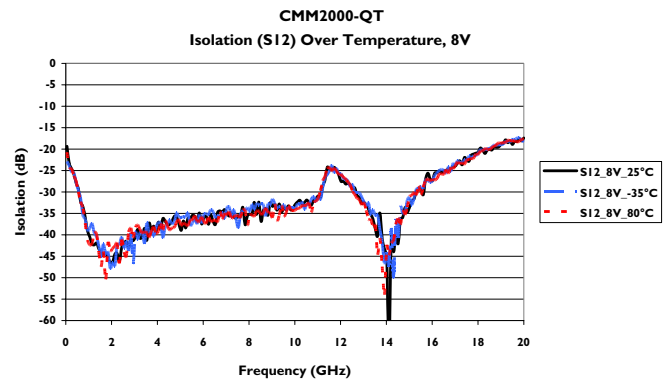
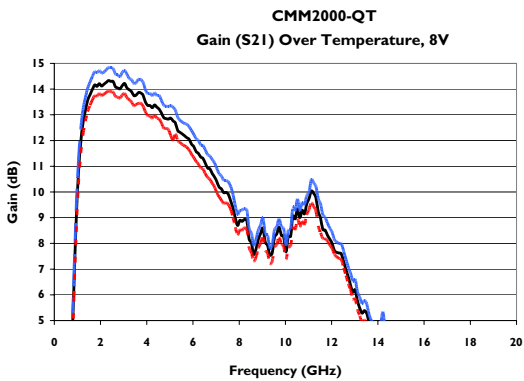
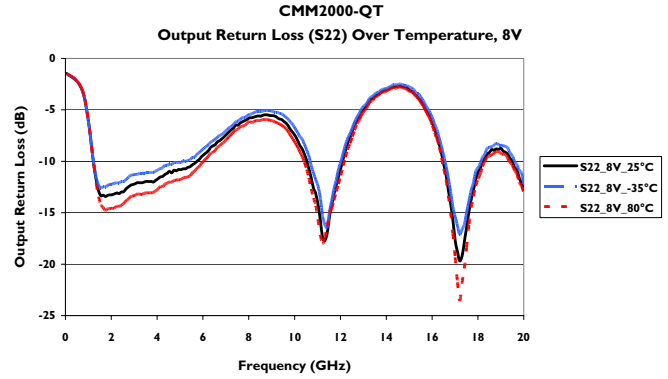
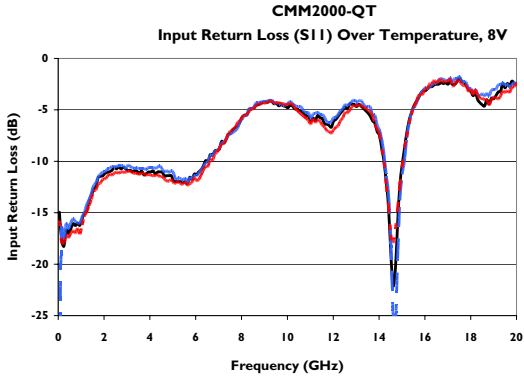

1.5-6.0 GHz GaAs MMIC Packaged Driver Amplifier



January 2008 - Rev 28-Jan-08

CMM2000-QT
RoHS

Driver Amplifier Measurements (cont.)

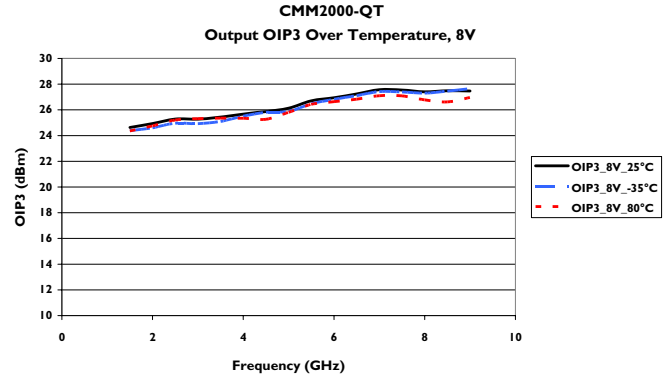
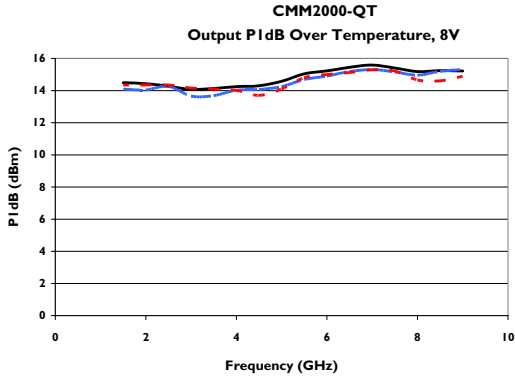

1.5-6.0 GHz GaAs MMIC Packaged Driver Amplifier

Evaluation Board Layout

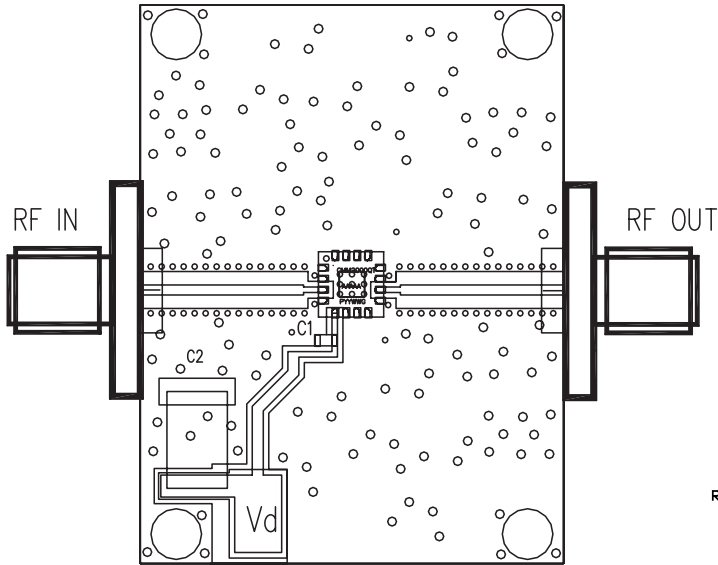

C1 = 1000pF
C2 = 1μF

Package Pin-out Table

Pin Designator	Description
1,2,4,6,7,8,9, 11,12,13,14,15,16	NC
3	RF Input
10	RF Output
5	Vd

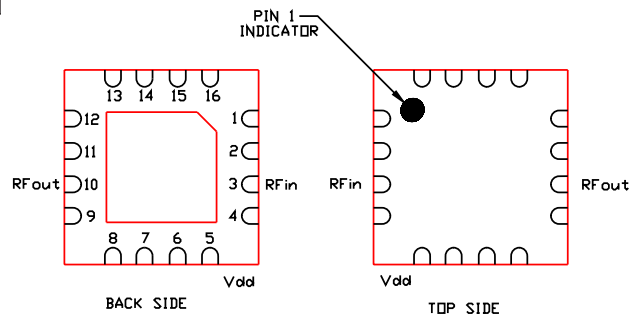

We recommend to ground all non-connected pins and to have as many via holes as possible under the ground paddle.

Evaluation Board Schematic

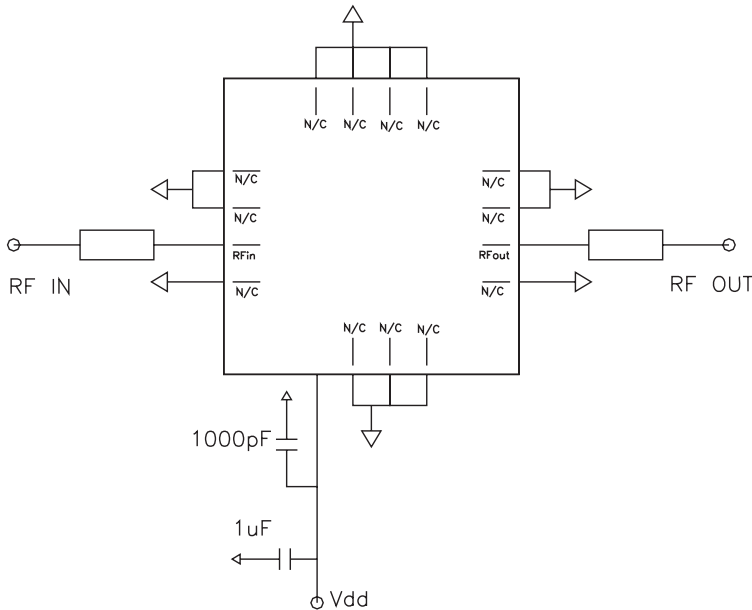

The input and output require DC blocking capacitors if external DC voltages are present on the RF lines.

1.5-6.0 GHz GaAs MMIC Packaged Driver Amplifier

January 2008 - Rev 28-Jan-08

CMM2000-QT
RoHS

Package Outline and Assembly

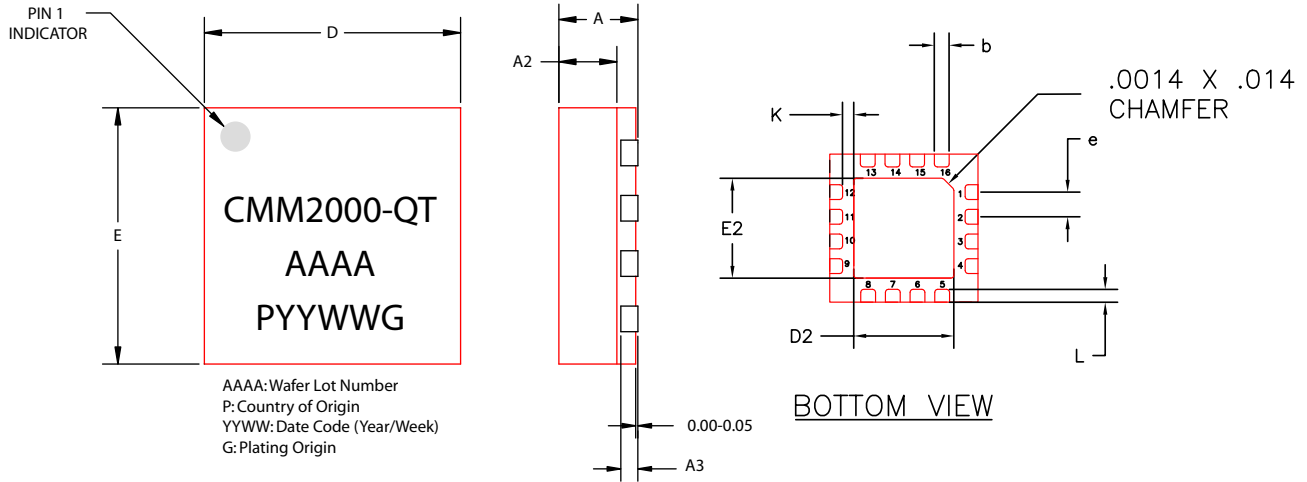

RECOMMENDED SOLDER PAD PITCH AND DIMENSIONS

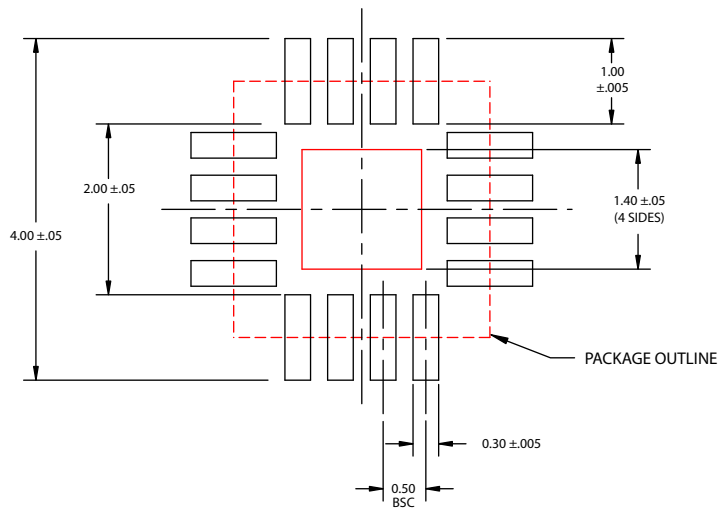

NOTE:

1. ALL DIMENSIONS ARE IN mm

	MIN	NOM	MAX
A	0.80	0.90	1.00
A3		0.20 REF	
A2	0	0.65	1.00
b	0.20	0.25	0.30
K	0.20	-	-
D		3.00 BSC	
E		3.00 BSC	
e		0.50	
D2	1.50	1.65	1.80
E2	1.50	1.65	1.80
L	0.16	0.26	0.36

1.5-6.0 GHz GaAs MMIC Packaged Driver Amplifier

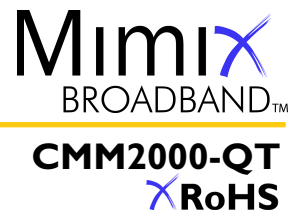

January 2008 - Rev 28-Jan-08

Handling and Assembly Information

CAUTION! - Mimix Broadband MMIC Products contain gallium arsenide (GaAs) which can be hazardous to the human body and the environment. For safety, observe the following procedures:

- Do not ingest.
- Do not alter the form of this product into a gas, powder, or liquid through burning, crushing, or chemical processing as these by-products are dangerous to the human body if inhaled, ingested, or swallowed.
- Observe government laws and company regulations when discarding this product. This product must be discarded in accordance with methods specified by applicable hazardous waste procedures.

Life Support Policy - Mimix Broadband's products are not authorized for use as critical components in life support devices or systems without the express written approval of the President and General Counsel of Mimix Broadband. As used herein: (1) Life support devices or systems are devices or systems which, (a) are intended for surgical implant into the body, or (b) support or sustain life, and whose failure to perform when properly used in accordance with instructions for use provided in the labeling, can be reasonably expected to result in a significant injury to the user. (2) A critical component is any component of a life support device or system whose failure to perform can be reasonably expected to cause the failure of the life support device or system, or to affect its safety or effectiveness.

Package Attachment - This packaged product from Mimix Broadband is provided as a rugged surface mount package compatible with high volume solder installation. Care should be taken not to apply heavy pressure to the top or base material to avoid package damage. Vacuum tools or other suitable pick and place equipment may be used to pick and place this part. Care should be taken to ensure that there are no voids or gaps in the solder connection so that good RF, DC and ground connections are maintained. Voids or gaps can eventually lead not only to RF performance degradation, but reduced reliability and life of the product due to thermal stress.

Mimix Lead-Free RoHS Compliant Program - Mimix has an active program in place to meet customer and governmental requirements for eliminating lead (Pb) and other environmentally hazardous materials from our products. All Mimix RoHS compliant components are form, fit and functional replacements for their non-RoHS equivalents. Lead plating of our RoHS compliant parts is 100% matte tin (Sn) over copper alloy and is backwards compatible with current standard SnPb low-temperature reflow processes as well as higher temperature (260°C reflow) "Pb Free" processes.

Ordering Information

<u>Part Number for Ordering</u>	<u>Description</u>
CMM2000-QT-0G00	Matte Tin finished RoHS compliant 3x3 QFN in bulk quantity
CMM2000-QT-0G0T	Matte Tin finished RoHS compliant 3x3 QFN in tape and reel
PB-CMM2000-QT-0000	Evaluation Board