

Dual Push-Pull Laser Driver Oscillator



The EL6208 is a dual push-pull oscillator used to reduce laser noise in twin laser diodes. It uses the standard interface to existing ROM controllers. The frequency and amplitude are both set with a separate resistor connected to ground. The tiny package and harmonic reduction allow the part to be placed close to a laser with low RF emissions. An auto turn-off feature allows activates the oscillator only when the APC current is applied.

If the APC current is reduced such that the average laser voltage drops to less than 1.1V, the output and oscillator are disabled, reducing power consumption to a minimum.

The current drawn by the oscillator consists of a small utility current, plus the peak output amplitude in the positive cycle. In the negative cycle the oscillator subtracts peak output amplitude from the laser APC current. The waveform is filtered to reduce EMI emissions.

The EL6208 operates from a signal +5V supply. Power consumption is very low. The EL6208 part is available in the space-saving 6 Ld SOT-23 package and is specified for operation from 0°C to +70°C.

Ordering Information

PART NUMBER	PART MARKING	PACKAGE	PKG. DWG. #
EL6208CW	7	6 Ld SOT-23	MDP0038
EL6208CW-T7*	7	6 Ld SOT-23	MDP0038
EL6208CW-T7A*	7	6 Ld SOT-23	MDP0038
EL6208CWZ	BPAA	6 Ld SOT-23 (Pb-free)	MDP0038
EL6208CWZ-T7*	BPAA	6 Ld SOT-23 (Pb-free)	MDP0038
EL6208CWZ-T7A*	BPAA	6 Ld SOT-23 (Pb-free)	MDP0038

*Please refer to TB347 for details on reel specifications.

NOTE: These Intersil Pb-free plastic packaged products employ special Pb-free material sets; molding compounds/die attach materials and 100% matte tin plate PLUS ANNEAL - e3 termination finish, which is RoHS compliant and compatible with both SnPb and Pb-free soldering operations. Intersil Pb-free products are MSL classified at Pb-free peak reflow temperatures that meet or exceed the Pb-free requirements of IPC/JEDEC J STD-020.

Features

- Low power dissipation
- User-selectable frequency from 60MHz to 600MHz controlled with a single resistor
- User-specified amplitude from 10mA_{P-P} to 100mA_{P-P} controlled with a single resistor
- Auto turn-off threshold
- Soft edges for reduced EMI
- Small 6 Ld SOT-23 package
- Pb-free available (RoHS compliant)

Applications

- CD-DVD ROM drives

Pinout

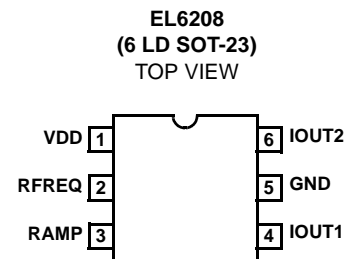

Absolute Maximum Ratings ($T_A = +25^\circ\text{C}$)

Voltages Applied to:

V_{DD}	-0.5V to +6.0V
I_{OUT}	-0.5V to +6.0V
R_{FREQ}, R_{RAMP}	-0.5V to +6.0V

Thermal Information

Operating Ambient Temperature Range 0°C to $+70^\circ\text{C}$
 Maximum Junction Temperature $+150^\circ\text{C}$
 Storage Temperature Range -65°C to $+150^\circ\text{C}$
 Output Current 100mA_{p-p}
 Power Dissipation (max) See Curves
 Pb-free reflow profile see link below
<http://www.intersil.com/pbfree/Pb-FreeReflow.asp>

Recommended Operating Conditions

V_{DD}	5V $\pm 10\%$
V_{OUT}2V to 3V
R_{FREQ}3k Ω (min)
R_{RAMP}	1.25k Ω (min)
f_{OSC}	60MHz to 600MHz
I_{OUT}10mA _{p-p} to 100mA _{p-p}

CAUTION: Do not operate at or near the maximum ratings listed for extended periods of time. Exposure to such conditions may adversely impact product reliability and result in failures not covered by warranty.

IMPORTANT NOTE: All parameters having Min/Max specifications are guaranteed. Typical values are for information purposes only. Unless otherwise noted, all tests are at the specified temperature and are pulsed tests, therefore: $T_J = T_C = T_A$

Supply and Reference Voltage Characteristics $V_{DD} = +5V, T_A = +25^\circ\text{C}, R_L = 10\Omega, R_{FREQ} = 5210\Omega (f_{OSC} = 360\text{MHz}), R_{RAMP} = 2540\Omega (I_{OUT} = 50\text{mA}_{p-p} \text{ measured at } 60\text{MHz}), V_{OUT} = 2.2V$

PARAMETER	DESCRIPTION	CONDITIONS	MIN (Note 1)	TYP	MAX (Note 1)	UNIT
PSOR	Power Supply Operating Range		4.5		5.5	V
I_{SO}	Supply Current Disabled	$V_{OUT} < V_{CUTOFF}$		280	440	μA
I_{STYP}	Supply Current Typical Conditions	$R_{FREQ} = 5.21\text{k}\Omega, R_{RAMP} = 2.54\text{k}\Omega$		20	23	mA
I_{SLO}	Supply Current Low Conditions	$R_{FREQ} = 18.2\text{k}\Omega, R_{RAMP} = 12.7\text{k}\Omega$		5.4		mA
I_{SHI}	Supply Current High Conditions	$R_{FREQ} = 3.3\text{k}\Omega, R_{RAMP} = 1.27\text{k}\Omega$		36.8		mA
V_{FREQ}	Voltage at RFREQ Pin			1.27		V
V_{RAMP}	Voltage on RAMP Pin			1.27		V
V_{CUTOFF}	Monitoring Voltage of IOUT Pin		1.1		1.4	V

Oscillator Characteristics $V_{DD} = +5V, T_A = +25^\circ\text{C}, R_L = 10\Omega, R_{FREQ} = 5210\Omega (f_{OSC} = 360\text{MHz}), R_{RAMP} = 2540\Omega (I_{OUT} = 50\text{mA}_{p-p} \text{ measured at } 60\text{MHz}), V_{OUT} = 2.2V$

PARAMETER	DESCRIPTION	CONDITIONS	MIN (Note 1)	TYP	MAX (Note 1)	UNIT
f_{OSC}	Frequency Tolerance	Unit-unit frequency variation	310	358	400	MHz
f_{HIGH}	Frequency Range High	$R_{FREQ} = 3.3\text{k}\Omega$		566		MHz
f_{LOW}	Frequency Range Low	$R_{FREQ} = 18.2\text{k}\Omega$		100		MHz
TC_{OSC}	Frequency Temperature Sensitivity	0°C to $+70^\circ\text{C}$ ambient		50		ppm/ $^\circ\text{C}$
$PSRR_{OSC}$	Frequency Change $\Delta F/F$	V_{DD} from 4.5V to 5.5V		1		%

Driver Characteristics $V_{DD} = +5V, T_A = +25^\circ\text{C}, R_L = 10\Omega, R_{FREQ} = 30.5\text{k}\Omega (f_{OSC} = 60\text{MHz}), R_{RAMP} = 2540\Omega (I_{OUT} = 50\text{mA}_{p-p} \text{ measured at } 60\text{MHz}), V_{OUT} = 2.2V$

PARAMETER	DESCRIPTION	CONDITIONS	MIN (Note 1)	TYP	MAX (Note 1)	UNIT
AMP_{HIGH}	Amplitude Range High	$R_{RAMP} = 1.27\text{k}\Omega$		100		mA _{p-p}
AMP_{LOW}	Amplitude Range Low	$R_{RAMP} = 12.7\text{k}\Omega$		10		mA _{p-p}
IOS_{NOM}	Offset Current @ 2.2V	$R_{FREQ} = 5210\Omega, V_{OUT} = 2.2V$		-4		mA
IOS_{HIGH}	Offset Current @ 2.8V	$R_{FREQ} = 5210\Omega, V_{OUT} = 2.8V$		-4.8		mA

EL6208

Driver Characteristics

$V_{DD} = +5V$, $T_A = +25^\circ C$, $R_L = 10\Omega$, $R_{FREQ} = 30.5k\Omega$ ($f_{OSC} = 60MHz$), $R_{AMP} = 2540\Omega$ ($I_{OUT} = 50mA_{P-P}$ measured at 60MHz), $V_{OUT} = 2.2V$ **(Continued)**

PARAMETER	DESCRIPTION	CONDITIONS	MIN (Note 1)	TYP	MAX (Note 1)	UNIT
$I_{OS_{LOW}}$	Offset Current @ 1.8V	$R_{FREQ} = 5210\Omega$, $V_{OUT} = 1.8V$		-3.5		mA
I_{OUTP-P}	Output Current Tolerance	Defined as one standard deviation		2		%
Duty Cycle	Output Push Time/Cycle Time	$R_{FREQ} = 5210\Omega$		43		%
$PSRR_{AMP}$	Amplitude Change of Output $\Delta I/I$	V_{DD} from 4.5V to 5.5V		-54		dB
t_{ON}	Auto Turn-on Time	Output voltage step from 0V to 2.2V		15		μs
t_{OFF}	Auto Turn-off Time	Output voltage step from 2.2V to 0V		0.5		μs
I_{OUTN}	Output Current Noise Density	$R_{FREQ} = 5210\Omega$, measured @ 10MHz		2.5		nA/\sqrt{Hz}

NOTES:

- Parts are 100% tested at +25°C. Over-temperature limits established by characterization and are not production tested.

Pin Descriptions

PIN NAME	PIN TYPE	PIN DESCRIPTION
1	VDD	Positive power for laser driver (4.5V to 5.5V)
2	RFREQ	Set pin for oscillator frequency
3	RAMP	Set pin for output current amplitude
4	IOUT1	Current output to laser diode
5	GND1	Chip ground pin (0V for output)
6	IOUT2	Current output to laser diode

I_{OUT} Control

V_{OUT}	I_{OUT}
Less than V_{CUTOFF}	OFF
More than V_{CUTOFF}	Normal Operation

Typical Performance Curves $V_{DD} = 5V$, $T_A = +25^\circ C$, $R_L = 10\Omega$, $R_{FREQ} = 5.21k\Omega$, $R_{AMP} = 2.54k\Omega$, $V_{OUT} = 2.2V$ unless otherwise specified.

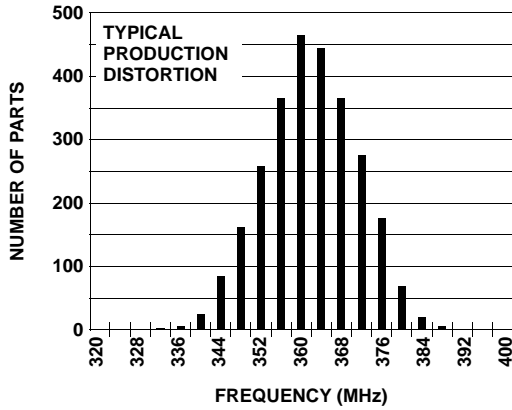

FIGURE 1. FREQUENCY DISTRIBUTION

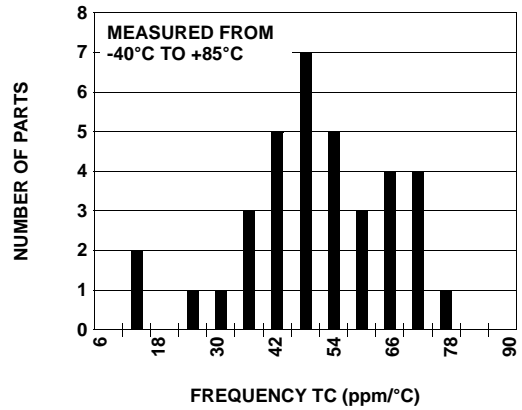

FIGURE 2. FREQUENCY DRIFT with TEMPERATURE

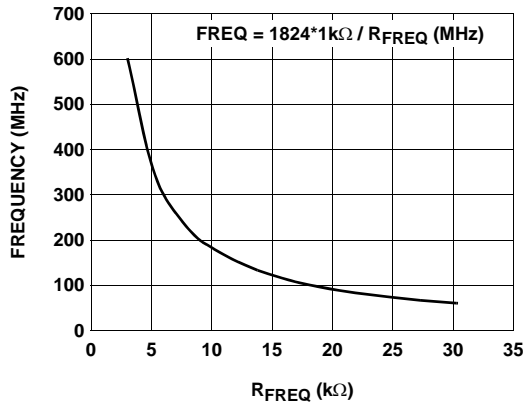

FIGURE 3. FREQUENCY vs R_{FREQ}

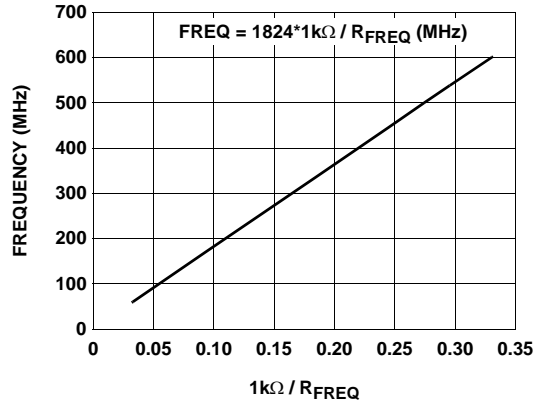

FIGURE 4. FREQUENCY vs $1/R_{FREQ}$

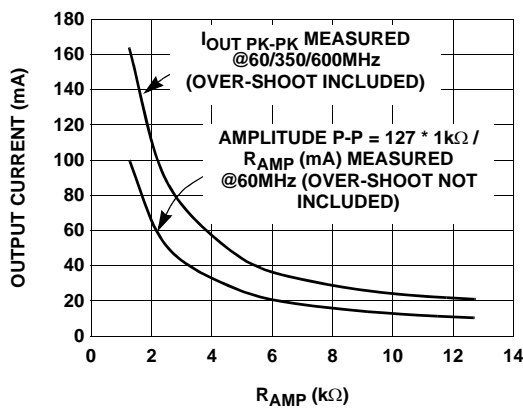

FIGURE 5. OUTPUT CURRENT vs R_{AMP}

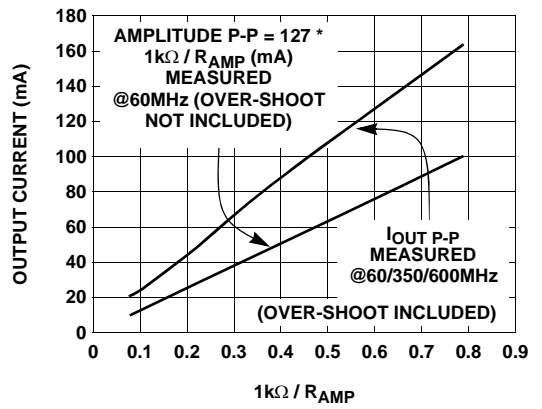

FIGURE 6. OUTPUT CURRENT vs $1/R_{AMP}$

Typical Performance Curves $V_{DD} = 5V$, $T_A = +25^\circ C$, $R_L = 10\Omega$, $R_{FREQ} = 5.21k\Omega$, $R_{AMP} = 2.54k\Omega$, $V_{OUT} = 2.2V$ unless otherwise specified. (Continued)

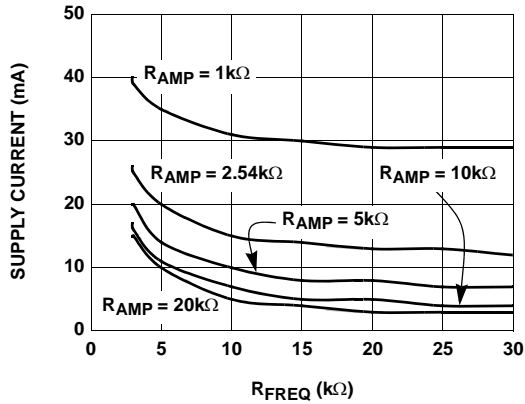

FIGURE 7. SUPPLY CURRENT vs R_{FREQ}

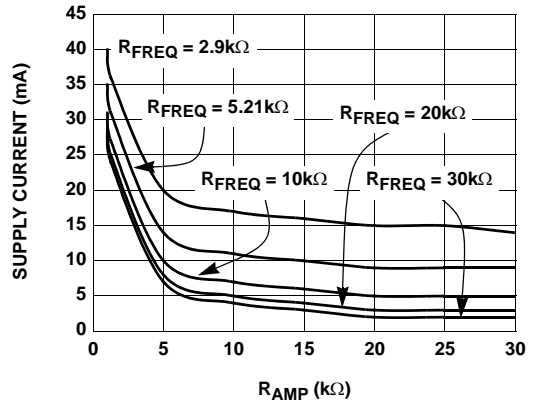

FIGURE 8. SUPPLY CURRENT vs R_{AMP}

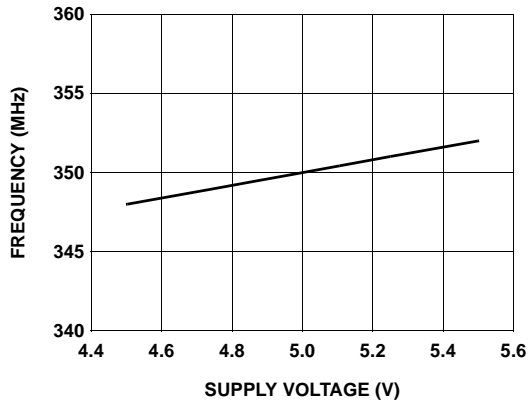

FIGURE 9. FREQUENCY vs SUPPLY VOLTAGE

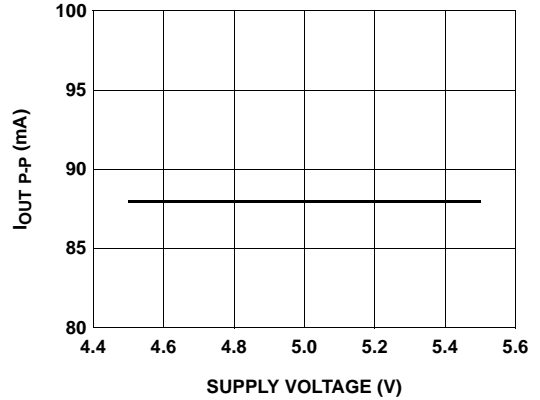

FIGURE 10. PEAK-TO-PEAK OUTPUT CURRENT vs SUPPLY VOLTAGE

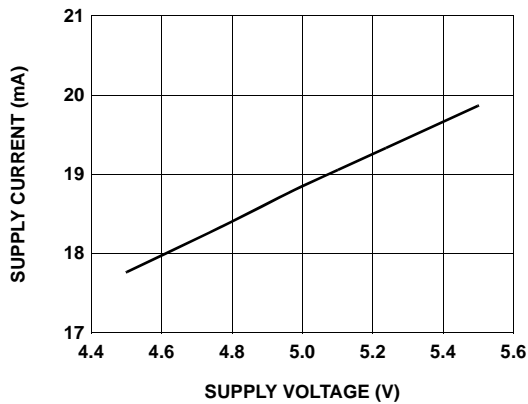

FIGURE 11. SUPPLY CURRENT vs SUPPLY VOLTAGE

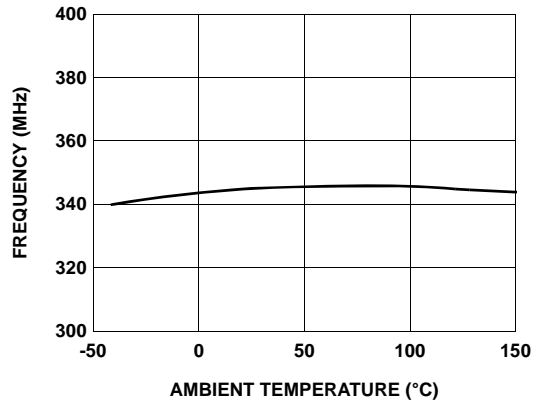

FIGURE 12. FREQUENCY vs TEMPERATURE

Typical Performance Curves $V_{DD} = 5V$, $T_A = +25^\circ C$, $R_L = 10\Omega$, $R_{FREQ} = 5.21k\Omega$, $RAMP = 2.54k\Omega$, $V_{OUT} = 2.2V$ unless otherwise specified. (Continued)

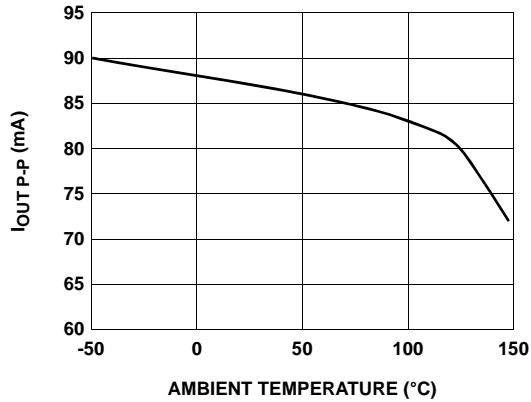

FIGURE 13. PEAK-TO-PEAK OUTPUT CURRENT vs TEMPERATURE

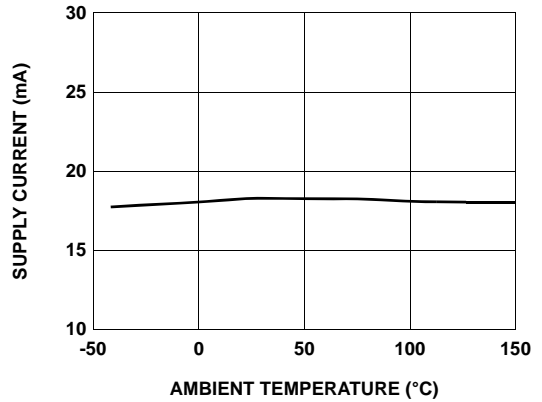

FIGURE 14. SUPPLY CURRENT vs TEMPERATURE

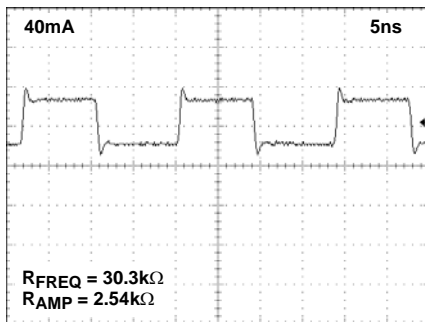

FIGURE 15. OUTPUT CURRENT @ 60MHz

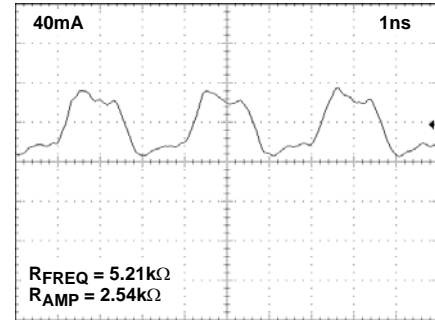

FIGURE 16. OUTPUT CURRENT @ 350MHz

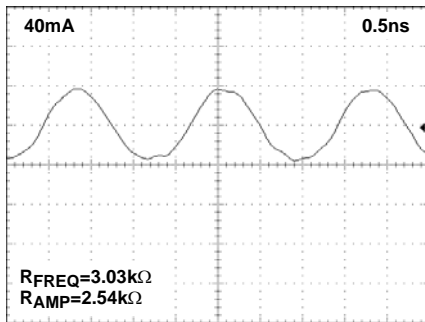

FIGURE 17. OUTPUT CURRENT @ 600MHz

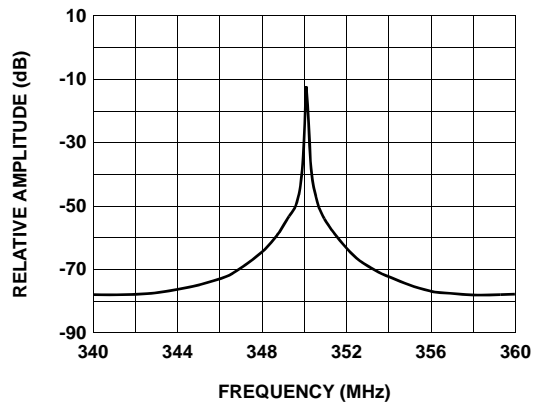
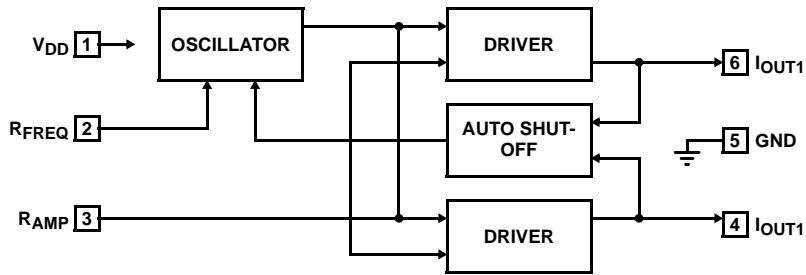
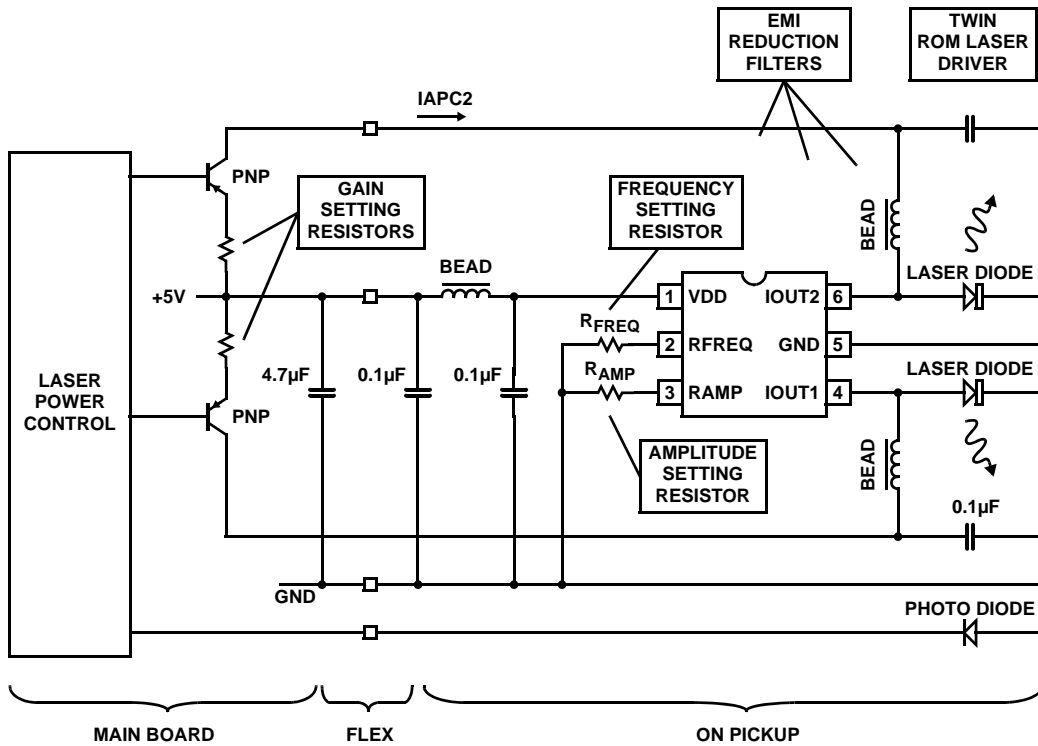

FIGURE 18. OUTPUT SPECTRUM - WIDEBAND

Block Diagram



Typical Application Diagram



Typical Waveforms

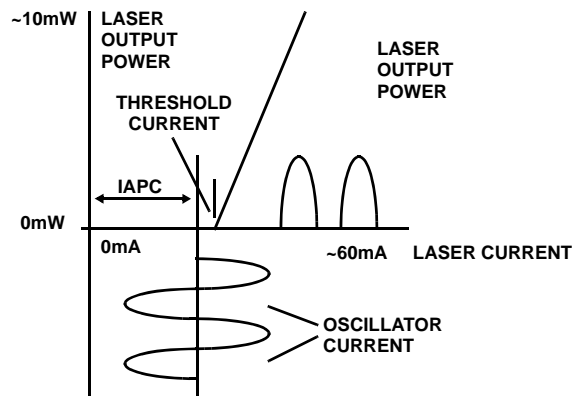

Applications Information

Product Description

The EL6208 is a solid state, low-power, high-speed laser modulation oscillator with external resistor-adjustable operating frequency and output amplitude. It is designed to interface easily to laser diodes to break up optical feedback resonant modes and thereby reduce laser noise. The output of the EL6208 is composed of a push-pull current source, switched alternately at the oscillator frequency. The output and oscillator are automatically disabled for power saving when the average laser voltage drops to less than 1.1V. The EL6208 has the operating frequency from 60MHz to 600MHz and the output current from 10mA_{P-P} to 100mA_{P-P}. The supply current is only 18.5mA for the output current of 50mA_{P-P} at the operating frequency of 350MHz.

Theory of Operation

A typical semiconductor laser will emit a small amount of incoherent light at low values of forward laser current. But after the threshold current is reached, the laser will emit coherent light. Further increases in the forward current will cause rapid increases in laser output power. A typical threshold current is 35mA and a typical slope efficiency is 0.7mW/mA.

When the laser is lasing, it will often change its mode of operation slightly, due to changes in current, temperature, or optical feedback into the laser. In a DVD-ROM, the optical feedback from the moving disk forms a significant noise factor due to feedback-induced mode hopping. In addition to the mode hopping noise, a diode laser will roughly have a constant noise level regardless of the power level when a threshold current is exceeded.

The oscillator is designed to produce a low noise oscillating current that is added to the external DC current. The effective AC current is to cause the laser power to change at the oscillator frequency. This change causes the laser to go through rapid mode hopping. The low frequency component of laser power noise due to mode hopping is translated up to sidebands around the oscillator frequency by this action. Since the oscillator frequency can be filtered out of the low frequency read and serve channels, the net result is that the laser noise seems to be reduced. The second source of laser noise reduction is caused by the increase in the laser power above the average laser power during the pushing-current time. The signal-to-noise ratio (SNR) of the output power is better at higher laser powers because of the almost constant noise power when a threshold current is exceeded. In addition, when the laser is off during the pulling-current time, the noise is also very low.

R_{AMP} and R_{FREQ} Value Setting

The laser should always have a forward current during operation. This will prevent the laser voltage from collapsing,

and ensure that the high frequency components reach the junction without having to charge the junction capacitance.

Generally it is desirable to make the oscillator currents as large as possible to obtain the greatest reduction in laser noise. But it is not a trivial matter to determine this critical value. The amplitude depends on the wave shape of the oscillator current reaching the laser junction.

If the output current is sinusoidal, and the components in the output circuit are fixed and linear, then the shape of the current will be sinusoidal. But the amount of current reaching the laser junction is a function of the circuit parasitics. These parasitics can result in a resonant increase in output depending on the frequency due to the junction capacitance and layout. Also, the amount of junction current causing laser emission is variable with frequency due to the junction capacitance. In conclusion, the sizes of the R_{AMP} and R_{FREQ} resistors must be determined experimentally. A good starting point is to take a value of R_{AMP} for a peak-to-peak current amplitude less than the minimum laser threshold current and a value of R_{FREQ} for an output current close to a sinusoidal wave form (refer to the "Typical Performance Curves" on page 4).

R_{AMP} and R_{FREQ} Pin Interfacing

Figure 19 shows an equivalent circuit of pins associated with the R_{AMP} and R_{FREQ} resistors. V_{REF} is roughly 1.27V for both R_{AMP} and R_{FREQ}. The R_{AMP} and R_{FREQ} resistors should be connected to the non-load side of the power ground to avoid noise pick-up. These resistors should also return to the EL6208's ground very directly to prevent noise pickup. They also should have minimal capacitance to ground. Trimmer resistors can be used to adjust initial operating points.

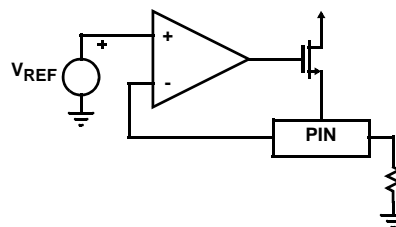

FIGURE 19. R_{AMP} AND R_{FREQ} PIN INTERFACE

External voltage sources can be coupled to the R_{AMP} and R_{FREQ} pins to effect frequency or amplitude modulation or adjustment. It is recommended that a coupling resistor of 1k be installed in series with the control voltage and mounted directly next to the pin. This will keep the inevitable high-frequency noise of the EL6208's local environment from propagating to the modulation source, and it will keep parasitic capacitance at the pin minimized.

Supply Bypassing and Grounding

The resistance of bypass-capacitors and the inductance of bonding wires prevent perfect bypass action, and 150mV_{P-P}

noise on the power lines is common. There needs to be a lossy bead inductance and secondary bypass on the supply side to control signals from propagating down the wires. Figure 20 shows the typical connection.

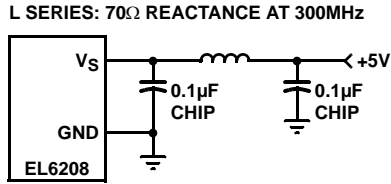

FIGURE 20. RECOMMENDED SUPPLY BYPASSING

Also important is circuit-board layout. At the EL6208's operating frequencies, even the ground plane is not low-impedance. High frequency current will create voltage drops in the ground plane. Figure 21 shows the output current loops.

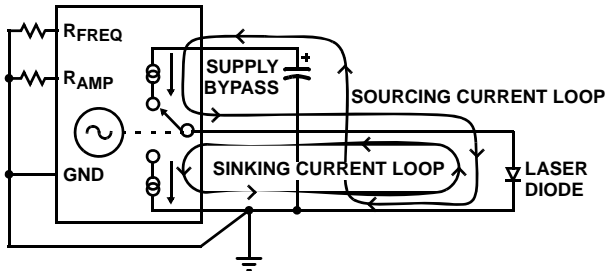

FIGURE 21. OUTPUT CURRENT LOOPS

For the pushing current loop, the current flows through the bypass capacitor, into the EL6208 supply pin, out the I_{OUT} pin to the laser, and from the laser back to the decoupling capacitor. This loop should be small.

For the pulling current loop, the current flows into the I_{OUT} pin, out of the ground pin, to the laser cathode, and from the laser diode back to the I_{OUT} pin. This loop should also be small.

Power Dissipation

With the high output drive capability, the EL6208 is possible to exceed the +125°C “absolute-maximum junction temperature” under certain conditions. Therefore, it is important to calculate the maximum junction temperature for the application to determine if the conditions need to be modified for the oscillator to remain in the safe operating area.

The maximum power dissipation allowed in a package is determined according to Equation 1:

$$P_{DMAX} = \frac{T_{JMAX} - T_{AMAX}}{\Theta_{JA}} \quad (EQ. 1)$$

where:

P_{DMAX} = Maximum power dissipation in the package

T_{JMAX} = Maximum junction temperature

T_{AMAX} = Maximum ambient temperature

θ_{JA} = Thermal resistance of the package

The supply current of the EL6208 depends on the peak-to-peak output current and the operating frequency which are determined by resistors R_{AMP} and R_{FREQ}. The supply current can be predicted approximately by Equation 2:

$$I_{SUP} = \frac{31.25mA \times 1k\Omega}{R_{AMP}} + \frac{30mA \times 1k\Omega}{R_{FREQ}} + 0.6mA \quad (EQ. 2)$$

The power dissipation can be calculated from Equation 3:

$$P_D = V_{SUP} \times I_{SUP} \quad (EQ. 3)$$

Here, V_{SUP} is the supply voltage. Figures 22 and provide a convenient way to see if the device will overheat. The maximum safe power dissipation can be found graphically, based on the package type and the ambient temperature. By using the previous equation, it is a simple matter to see if PD exceeds the device's power derating curve. To ensure proper operation, it is important to observe the recommended derating curve shown in Figures 22 and . A flex circuit may have a higher θ_{JA}, and lower power dissipation would then be required.

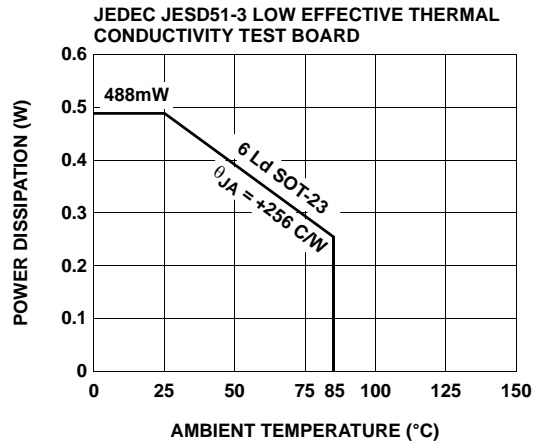

FIGURE 22. PACKAGE POWER DISSIPATION vs AMBIENT TEMPERATURE

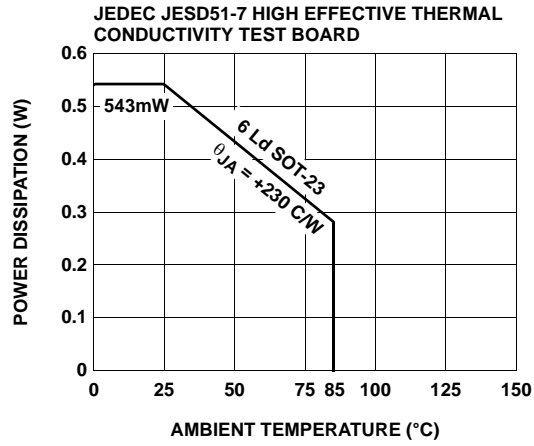
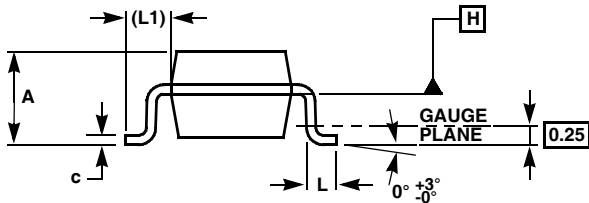
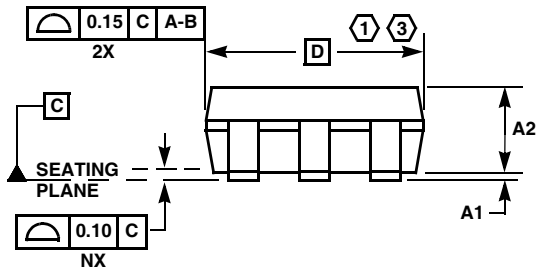
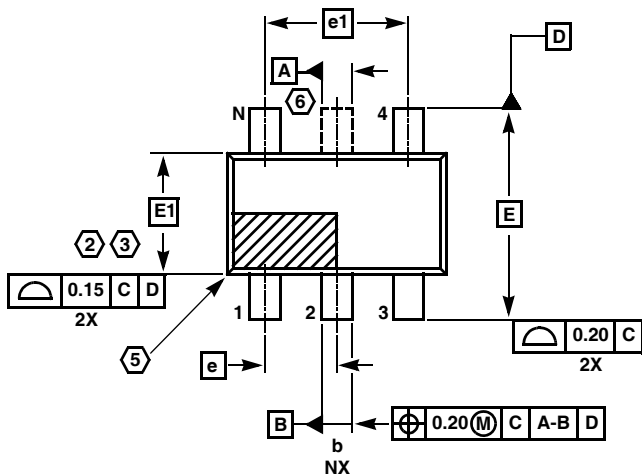

FIGURE 23. PACKAGE POWER DISSIPATION vs AMBIENT TEMPERATURE

SOT-23 Package Family



MDP0038

SOT-23 PACKAGE FAMILY

SYMBOL	MILLIMETERS		TOLERANCE
	SOT23-5	SOT23-6	
A	1.45	1.45	MAX
A1	0.10	0.10	±0.05
A2	1.14	1.14	±0.15
b	0.40	0.40	±0.05
c	0.14	0.14	±0.06
D	2.90	2.90	Basic
E	2.80	2.80	Basic
E1	1.60	1.60	Basic
e	0.95	0.95	Basic
e1	1.90	1.90	Basic
L	0.45	0.45	±0.10
L1	0.60	0.60	Reference
N	5	6	Reference

Rev. F 2/07

NOTES:

1. Plastic or metal protrusions of 0.25mm maximum per side are not included.
2. Plastic interlead protrusions of 0.25mm maximum per side are not included.
3. This dimension is measured at Datum Plane "H".
4. Dimensioning and tolerancing per ASME Y14.5M-1994.
5. Index area - Pin #1 I.D. will be located within the indicated zone (SOT23-6 only).
6. SOT23-5 version has no center lead (shown as a dashed line).

All Intersil U.S. products are manufactured, assembled and tested utilizing ISO9000 quality systems. Intersil Corporation's quality certifications can be viewed at www.intersil.com/design/quality

Intersil products are sold by description only. Intersil Corporation reserves the right to make changes in circuit design, software and/or specifications at any time without notice. Accordingly, the reader is cautioned to verify that data sheets are current before placing orders. Information furnished by Intersil is believed to be accurate and reliable. However, no responsibility is assumed by Intersil or its subsidiaries for its use; nor for any infringements of patents or other rights of third parties which may result from its use. No license is granted by implication or otherwise under any patent or patent rights of Intersil or its subsidiaries.

For information regarding Intersil Corporation and its products, see www.intersil.com