

FEATURES

Low supply current: 250 μ A max
Very low input bias current: 1 pA max
Low offset voltage: 750 μ V max
Single-supply operation: 5 V to 26 V
Dual-supply operation: ± 2.5 V to ± 13 V
Rail-to-rail output
Unity-gain stable
No phase reversal
SC70 package

APPLICATIONS

Line-/battery-powered instruments
Photodiode amplifiers
Precision current sensing
Medical instrumentation
Industrial controls
Precision filters
Portable audio
ATE

GENERAL DESCRIPTION

The AD8641/AD8642/AD8643 are low power, precision JFET input amplifiers featuring extremely low input bias current and rail-to-rail output. The ability to swing nearly rail-to-rail at the input and rail-to-rail at the output enables designers to buffer CMOS DACs, ASICs, and other wide output swing devices in single-supply systems. The outputs remain stable with capacitive loads of more than 500 pF.

The AD8641/AD8642/AD8643 are suitable for applications utilizing multichannel boards that require low power to manage heat. Other applications include photodiodes, ATE reference level drivers, battery management, and industrial controls.

The AD8641/AD8642/AD8643 are fully specified over the extended industrial temperature range of -40°C to $+125^{\circ}\text{C}$. The AD8641 is available in 5-lead SC70 and 8-lead SOIC lead-free packages. The AD8642 is available in 8-lead MSOP and 8-lead SOIC lead-free packages. The AD8643 is available in 14-lead SOIC and 16-lead, $3\text{ mm} \times 3\text{ mm}$, LFCSP lead-free packages.

Rev. B

Information furnished by Analog Devices is believed to be accurate and reliable. However, no responsibility is assumed by Analog Devices for its use, nor for any infringements of patents or other rights of third parties that may result from its use. Specifications subject to change without notice. No license is granted by implication or otherwise under any patent or patent rights of Analog Devices. Trademarks and registered trademarks are the property of their respective owners.

PIN CONFIGURATIONS

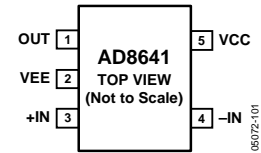

Figure 1. 5-Lead SC70 (KS-5)

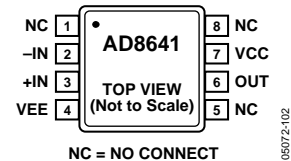

Figure 2. 8-Lead SOIC (R-8)



Figure 3. 8-Lead SOIC (R-8)

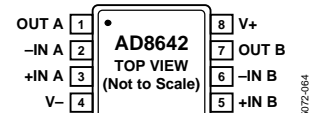

Figure 4. 8-Lead MSOP (RM-8)

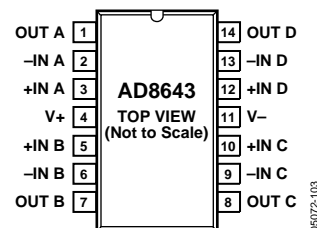

Figure 5. 14-Lead SOIC (R-14)

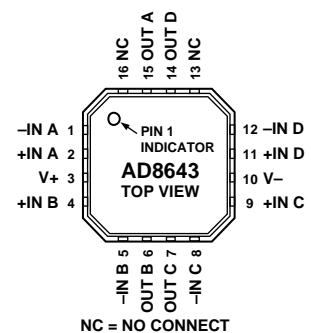

Figure 6. 16-Lead LFCSP (CP-16) (Not Drawn to Scale)

TABLE OF CONTENTS

Specifications..... 3
 Electrical Characteristics 3
Absolute Maximum Ratings..... 5
 ESD Caution..... 5
Typical Performance Characteristics 6
Outline Dimensions 13
 Ordering Guide..... 14

REVISION HISTORY

4/05—Rev. A to Rev. B

Added AD8643 Universal
Added 14-Lead SOIC Universal
Added 16-Lead LFCSP..... Universal
Updated Outline Dimensions 13
Changes to Ordering Guide 14

10/04—Initial Version: Revision 0

3/05—Rev. 0 to Rev. A

Added AD8642 Universal
Changes to General Description 1
Added Figure 3 and Figure 4..... 1
Changes to Specifications 3
Changes to Absolute Maximum Ratings 5
Changes to Figure 22..... 8
Changes to Figure 23..... 9
Changes to Figure 41 12
Updated Outline Dimensions 13
Changes to Ordering Guide 14

SPECIFICATIONS

ELECTRICAL CHARACTERISTICS

@ $V_S = 5.0\text{ V}$, $V_{CM} = 2.5\text{ V}$, $T_A = 25^\circ\text{C}$, unless otherwise noted.

Table 1.

Parameter	Symbol	Conditions	Min	Typ	Max	Unit
INPUT CHARACTERISTICS						
Offset Voltage	V_{OS}	AD8643 LFCSP only $-40^\circ\text{C} < T_A < +85^\circ\text{C}$ $+85^\circ\text{C} < T_A < +125^\circ\text{C}$, $V_{CM} = 1.5\text{ V}$		50	750	μV mV mV mV
Input Bias Current	I_B	$-40^\circ\text{C} < T_A < +125^\circ\text{C}$		0.25	1	pA
Input Offset Current	I_{OS}	$-40^\circ\text{C} < T_A < +125^\circ\text{C}$			180	pA
Input Voltage Range		$-40^\circ\text{C} < T_A < +125^\circ\text{C}$	0		60	pA
Common-Mode Rejection Ratio	CMRR	$V_{CM} = 0\text{ V to } 2.5\text{ V}$	74	93	3	V
Large Signal Voltage Gain	A_{VO}	$R_L = 10\text{ k}\Omega$, $V_O = 0.5\text{ to } 4.5\text{ V}$	80	140		dB
Offset Voltage Drift	$\Delta V_{OS}/\Delta T$	$-40^\circ\text{C} < T_A < +125^\circ\text{C}$		2.5		V/mV $\mu\text{V}/^\circ\text{C}$
OUTPUT CHARACTERISTICS						
Output Voltage High	V_{OH}	$I_L = 1\text{ mA}$, $-40^\circ\text{C to } +125^\circ\text{C}$	4.95			V
Output Voltage Low	V_{OL}	$I_L = 1\text{ mA}$, $-40^\circ\text{C to } +125^\circ\text{C}$	4.94		0.05	V
Output Current	I_{OUT}			0.01	0.05	V
				± 6		mA
POWER SUPPLY						
Power Supply Rejection Ratio	PSRR	$V_S = 5\text{ V to } 26\text{ V}$	90	107		dB
Supply Current/Amplifier	I_{SY}	$-40^\circ\text{C} < T_A < +125^\circ\text{C}$		195	250	μA
					270	μA
DYNAMIC PERFORMANCE						
Slew Rate	SR			2		V/ μs
Gain Bandwidth Product	GBP	AD8641, AD8642 AD8643		3		MHz
				2.5		MHz
Phase Margin	ϕ_m			50		Degrees
NOISE PERFORMANCE						
Voltage Noise	e_N p-p	$f = 0.1\text{ Hz to } 10\text{ Hz}$		4.0		$\mu\text{V p-p}$
Voltage Noise Density	e_N	$f = 1\text{ kHz}$		28.5		nV/ $\sqrt{\text{Hz}}$
Current Noise Density	i_N	$f = 1\text{ kHz}$		0.5		fA/ $\sqrt{\text{Hz}}$

AD8641/AD8642/AD8643

@ $V_S = \pm 13$ V, $V_{CM} = 0$ V, $T_A = 25^\circ\text{C}$, unless otherwise noted.

Table 2.

Parameter	Symbol	Conditions	Min	Typ	Max	Unit
INPUT CHARACTERISTICS						
Offset Voltage	V_{OS}	AD8643 LFCSP only $-40^\circ < T_A < +125^\circ\text{C}$		70	750	μV mV
Input Bias Current	I_B	$-40^\circ\text{C} < T_A < +125^\circ\text{C}$		0.25	1	pA
Input Offset Current	I_{OS}	$-40^\circ\text{C} < T_A < +125^\circ\text{C}$			260	pA
Input Voltage Range		$-40^\circ\text{C} < T_A < +125^\circ\text{C}$			65	pA
Common-Mode Rejection Ratio	CMRR	$V_{CM} = -13$ V to $+10$ V	-13		+10	V
Large Signal Voltage Gain	A_{VO}	$R_L = 10$ k Ω , $V_O = -11$ V to $+11$ V	90	107		dB
Offset Voltage Drift	$\Delta V_{OS}/\Delta T$	$-40^\circ\text{C} < T_A < +125^\circ\text{C}$	215	290		V/mV
OUTPUT CHARACTERISTICS						
Output Voltage High	V_{OH}	$I_L = 1$ mA, -40°C to $+125^\circ\text{C}$	+12.95			V
Output Voltage Low	V_{OL}	$I_L = 1$ mA, -40°C to $+125^\circ\text{C}$	+12.94		-12.95	V
Output Current	I_{OUT}			± 12	-12.94	V mA
POWER SUPPLY						
Power Supply Rejection Ratio	PSRR	$V_S = \pm 2.5$ V to ± 13 V	90	107		dB
Supply Current/Amplifier	I_{SY}	$-40^\circ\text{C} < T_A < +125^\circ\text{C}$		200	290	μA
					330	μA
DYNAMIC PERFORMANCE						
Slew Rate	SR			3		V/ μs
Gain Bandwidth Product	GBP			3.5		MHz
Phase Margin	ϕ_m			60		Degrees
NOISE PERFORMANCE						
Voltage Noise	e_N p-p	$f = 0.1$ Hz to 10 Hz		4.2		μV p-p
Voltage Noise Density	e_N	$f = 1$ kHz		27.5		nV/ $\sqrt{\text{Hz}}$
Current Noise Density	i_N	$f = 1$ kHz		0.5		fA/ $\sqrt{\text{Hz}}$

ABSOLUTE MAXIMUM RATINGS

Table 3.¹

Parameter	Rating
Supply Voltage	27.3 V
Input Voltage	VS- to VS+
Differential Input Voltage	±Supply Voltage
Output Short-Circuit Duration	Indefinite
Storage Temperature Range	
KS-5, R-8, RM-8, R-14, CP-16 Packages	-65°C to +150°C
Operating Temperature Range	-40°C to +125°C
Junction Temperature Range	
KS-5, R-8, RM-8, R-14, CP-16 Packages	-65°C to +150°C
Lead Temperature Range (Soldering, 60 sec)	300°C

Stresses above those listed under Absolute Maximum Ratings may cause permanent damage to the device. This is a stress rating only; functional operation of the device at these or any other conditions above those listed in the operational sections of this specification is not implied. Exposure to absolute maximum rating conditions for extended periods may affect device reliability.

ESD CAUTION

ESD (electrostatic discharge) sensitive device. Electrostatic charges as high as 4000 V readily accumulate on the human body and test equipment and can discharge without detection. Although this product features proprietary ESD protection circuitry, permanent damage may occur on devices subjected to high energy electrostatic discharges. Therefore, proper ESD precautions are recommended to avoid performance degradation or loss of functionality.



Table 4.

Package Type	θ_{JA}^2	θ_{JC}	Unit
5-Lead SC70 (KS)	331.4	223.9	°C/W
8-Lead SOIC (R)	157	56	°C/W
8-Lead MSOP (RM)	206	44	°C/W
14-Lead SOIC (R)	120	36	°C/W
16-Lead LFCSP (CP)	44	31.5	°C/W

¹ Absolute maximum ratings apply at 25°C, unless otherwise noted.

² θ_{JA} is specified for the worst-case conditions, that is, θ_{JA} is specified for devices soldered on circuit boards for surface-mounted packages.

TYPICAL PERFORMANCE CHARACTERISTICS

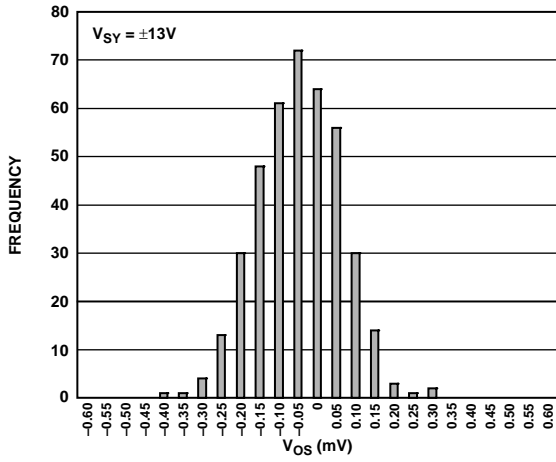

Figure 7. Input Offset Voltage

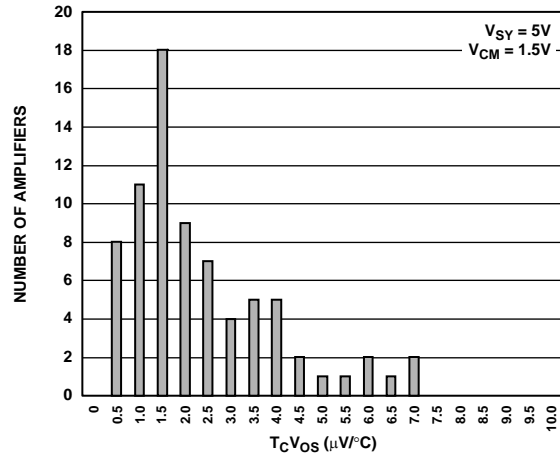

Figure 10. Offset Voltage Drift

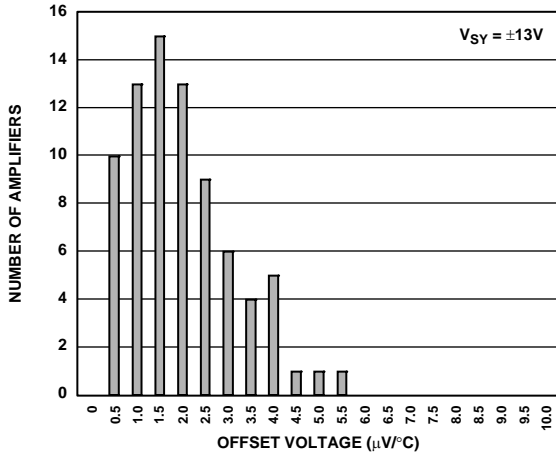

Figure 8. Offset Voltage Drift

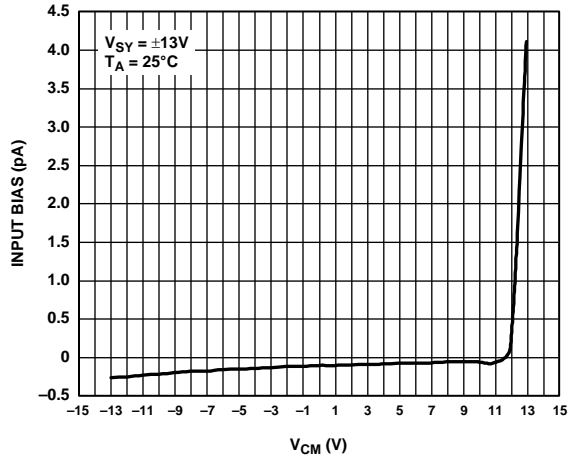

Figure 11. Input Bias Current vs. V_{CM}

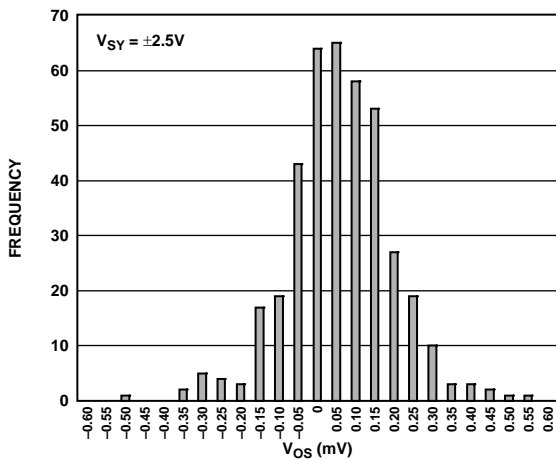

Figure 9. Input Offset Voltage

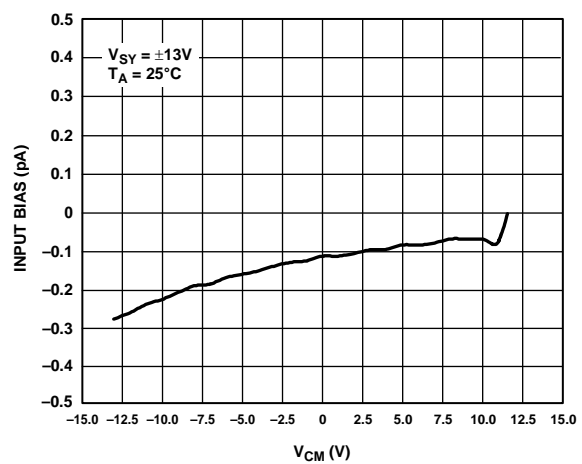

Figure 12. Input Bias Current vs. V_{CM}

05072-002

05072-005

05072-003

05072-006

05072-004

05072-007

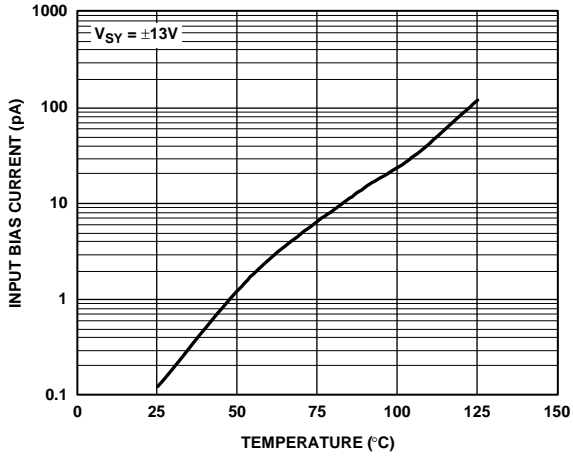

Figure 13. Input Bias Current vs. Temperature

06072-008

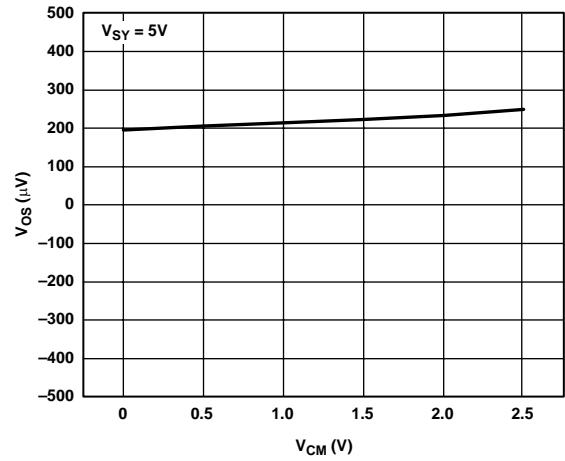

Figure 16. Input Offset Voltage vs. V_{CM}

06072-011

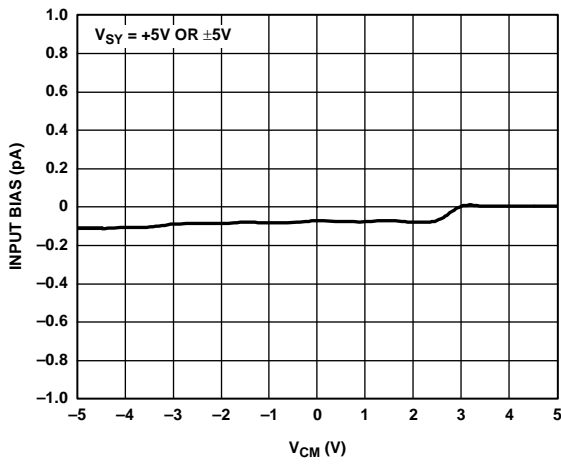

Figure 14. Input Bias Current vs. V_{CM}

06072-009

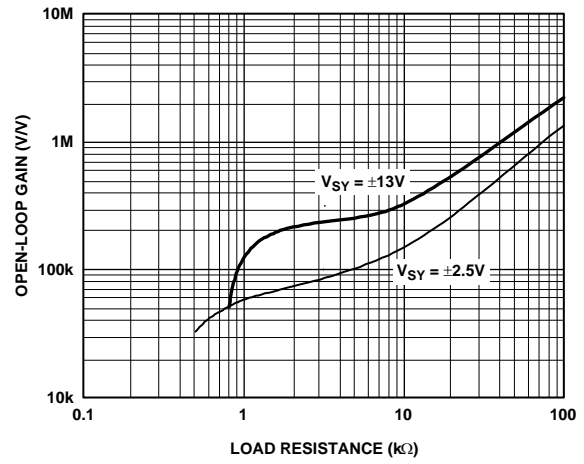

Figure 17. Open-Loop Gain vs. Load Resistance

06072-012

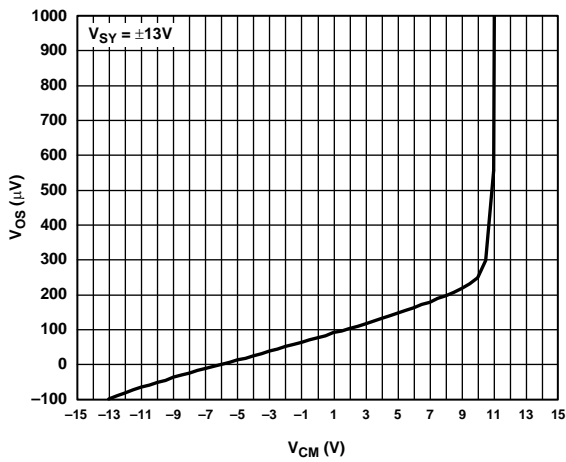

Figure 15. Input Offset Voltage vs. V_{CM}

06072-010

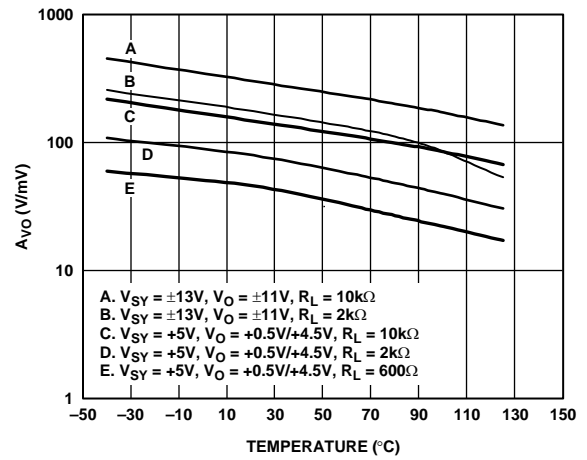

Figure 18. Open-Loop Gain vs. Temperature

06072-013

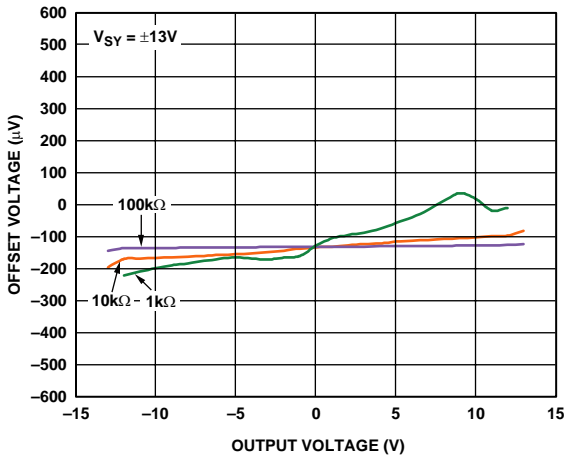

Figure 19. Input Error Voltage vs. Output Voltage for Resistive Loads

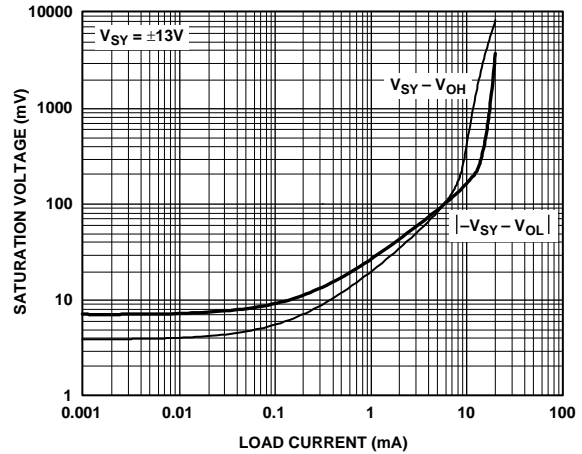

Figure 22. Output Saturation Voltage vs. Load Current

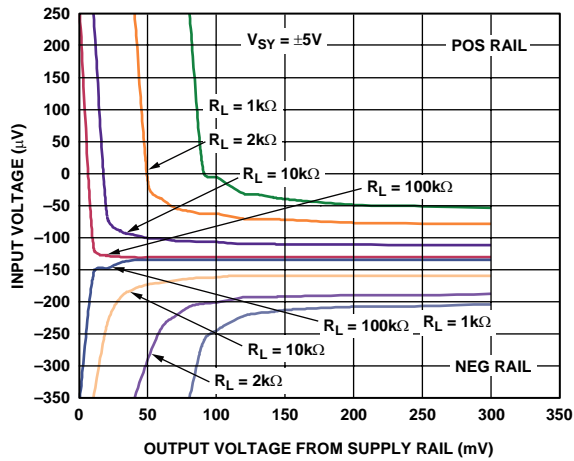

Figure 20. Input Error Voltage vs. Output Voltage Within 300 mV of Supply Rails

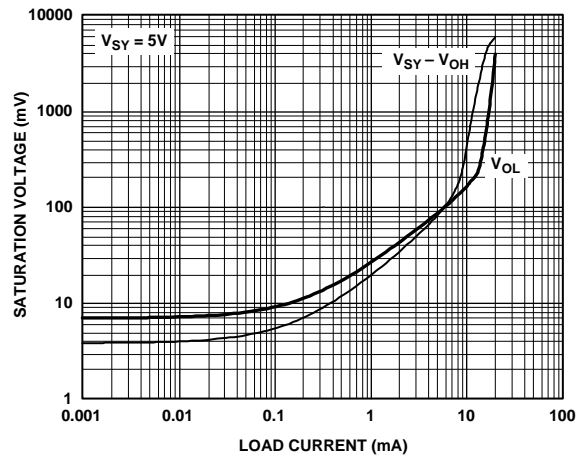

Figure 23. Output Saturation Voltage vs. Load Current

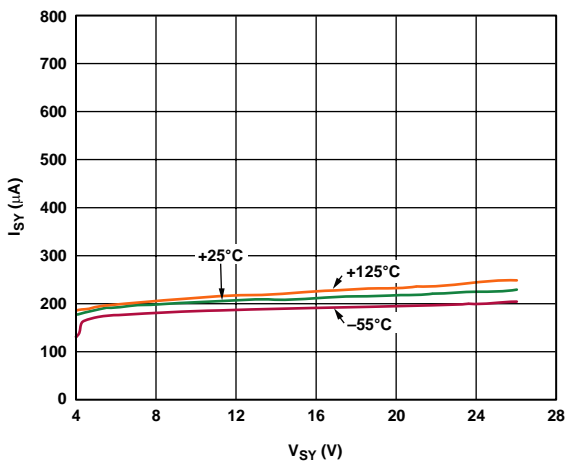

Figure 21. Quiescent Current vs. Supply Voltage at Different Temperatures

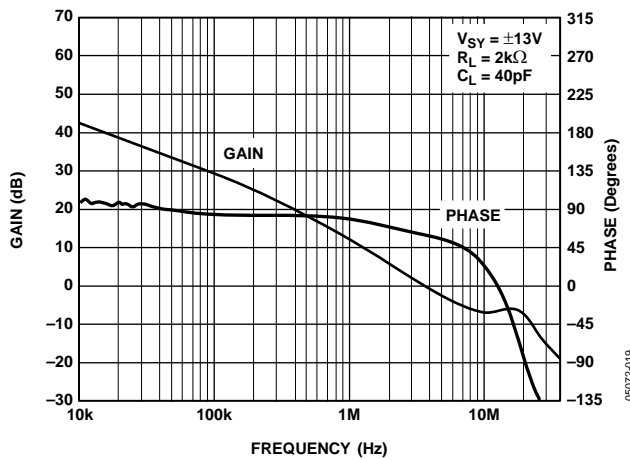

Figure 24. Open-Loop Gain and Phase Margin vs. Frequency

05072-014

05072-017

05072-015

05072-018

05072-016

05072-019

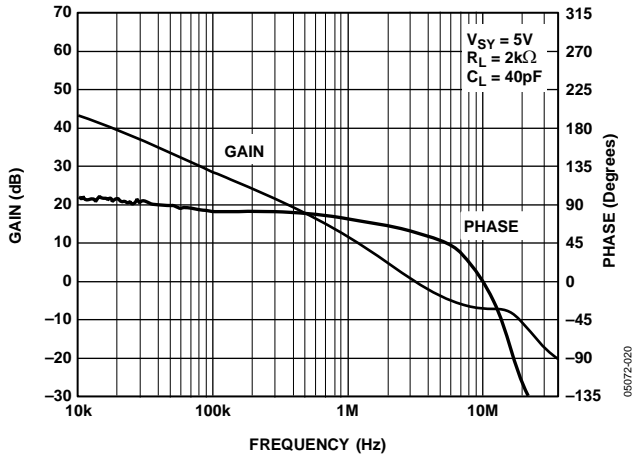

Figure 25. Open-Loop Gain and Phase Margin vs. Frequency

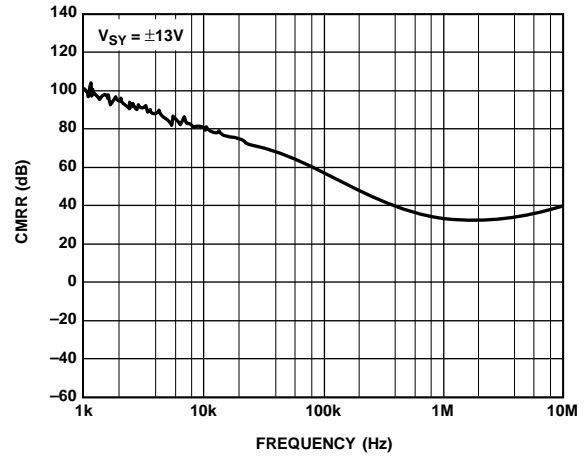

Figure 28. CMRR vs. Frequency

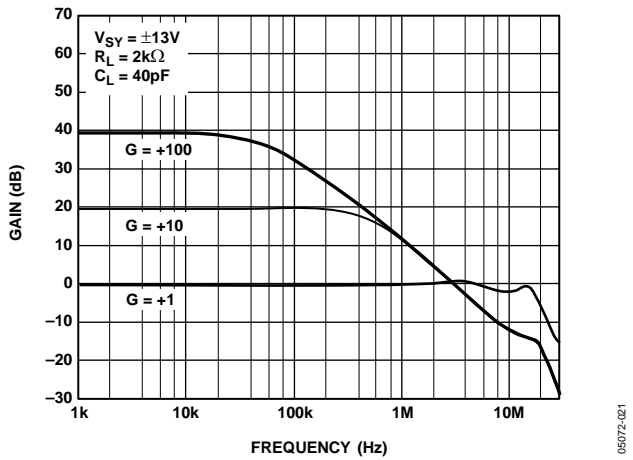

Figure 26. Closed-Loop Gain vs. Frequency

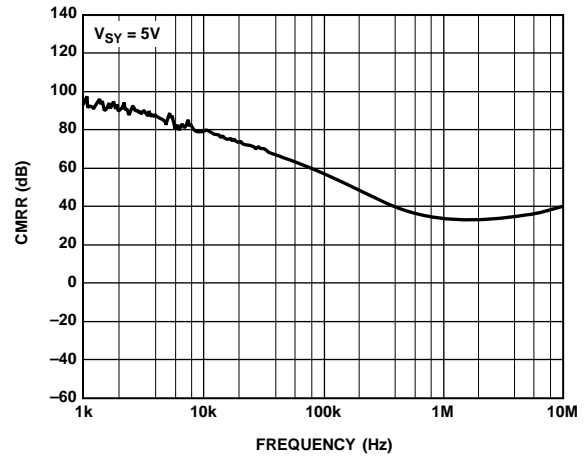

Figure 29. CMRR vs. Frequency

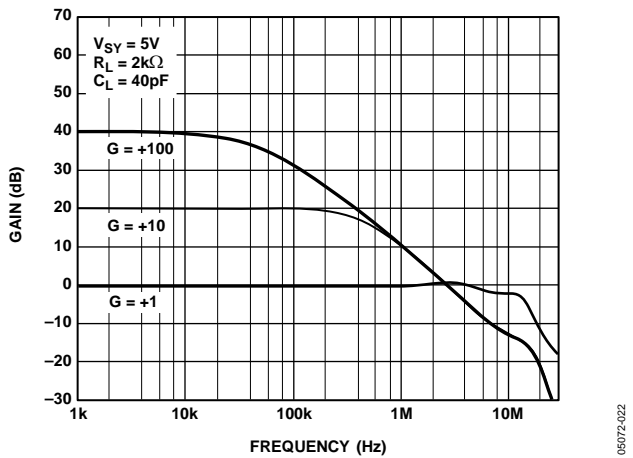

Figure 27. Closed-Loop Gain vs. Frequency

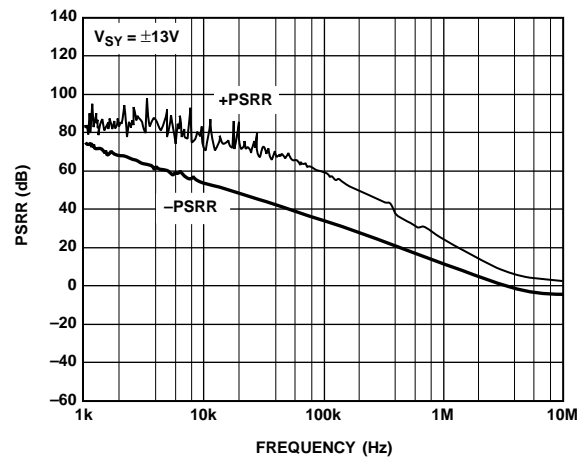

Figure 30. PSRR vs. Frequency

AD8641/AD8642/AD8643

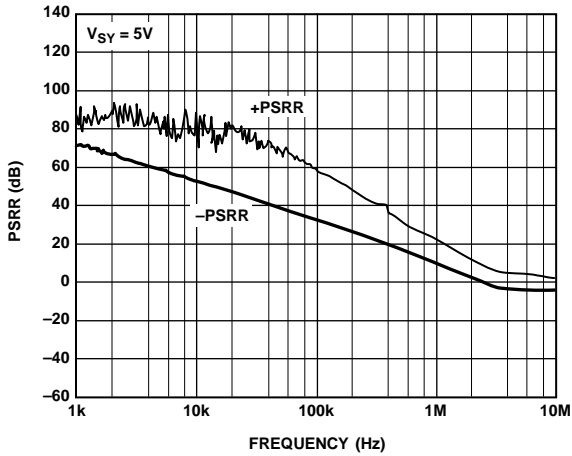

Figure 31. PSRR vs. Frequency

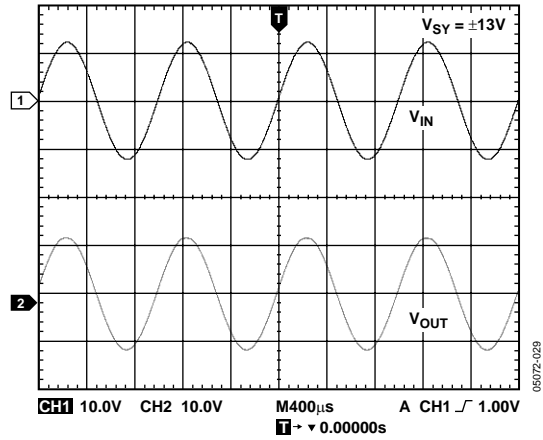

Figure 34. No Phase Reversal

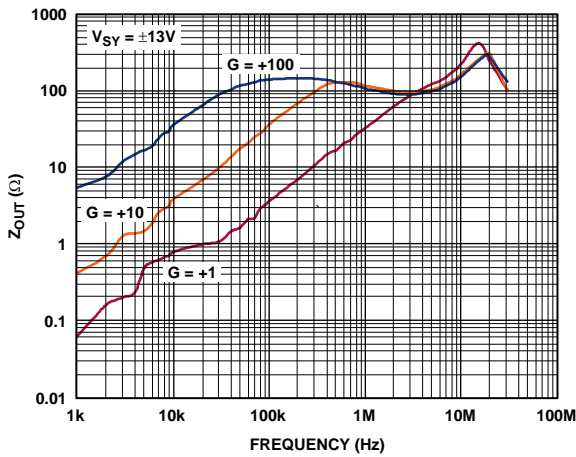

Figure 32. Output Impedance vs. Frequency

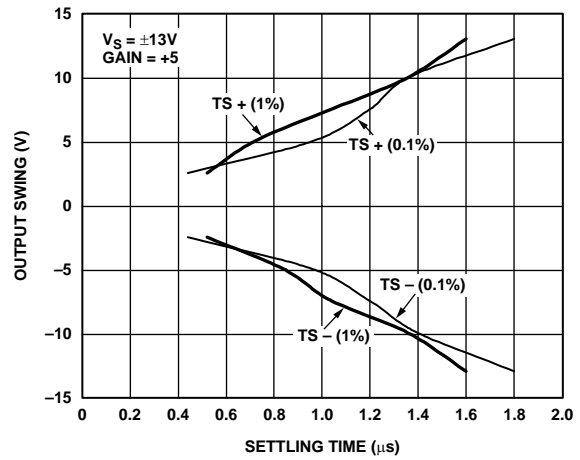

Figure 35. Output Swing and Error vs. Settling Time

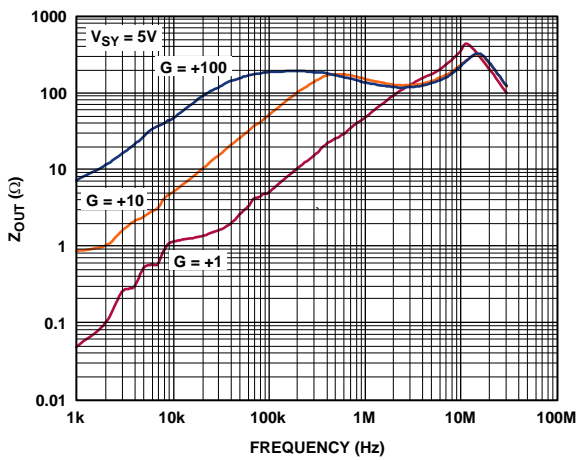

Figure 33. Output Impedance vs. Frequency

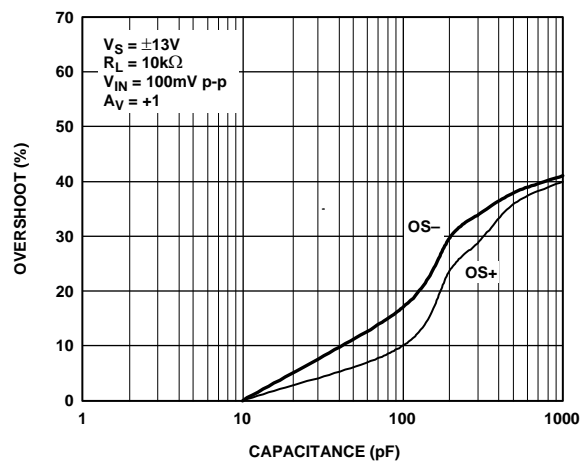

Figure 36. Small Signal Overshoot vs. Load Capacitance

05072-026

05072-027

05072-028

05072-029

05072-030

05072-031

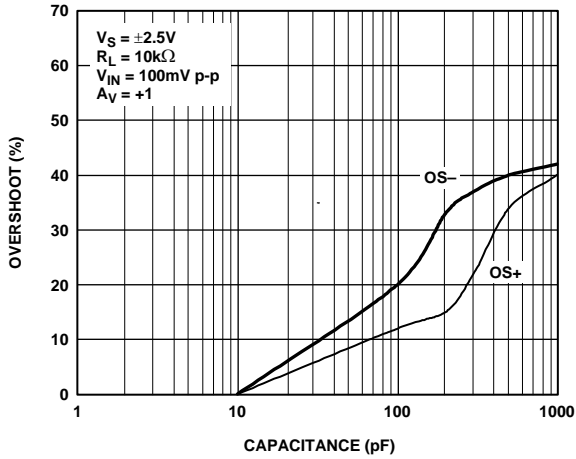

Figure 37. Small Signal Overshoot vs. Load Capacitance

05072-032

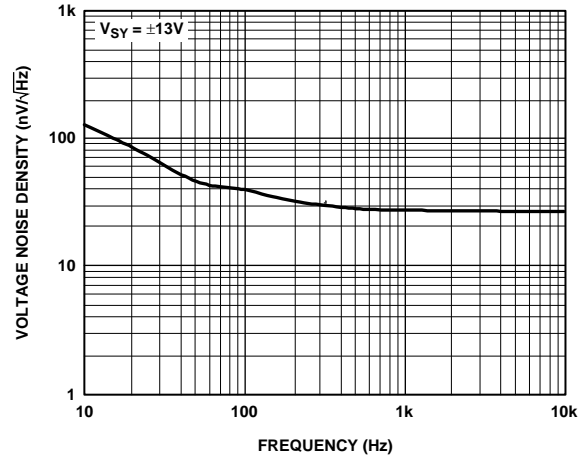

Figure 40. Voltage Noise Density

05072-035

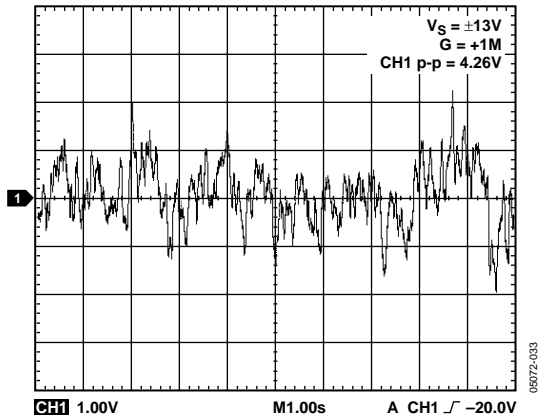

Figure 38. 0.1 Hz to 10 Hz Noise

05072-033

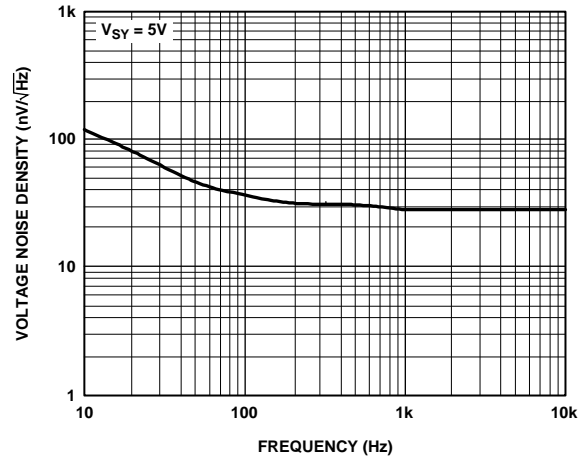

Figure 41. Voltage Noise Density

05072-036

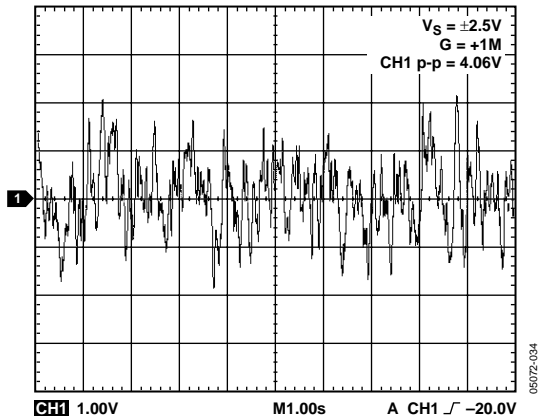

Figure 39. 0.1 Hz to 10 Hz Noise

05072-034

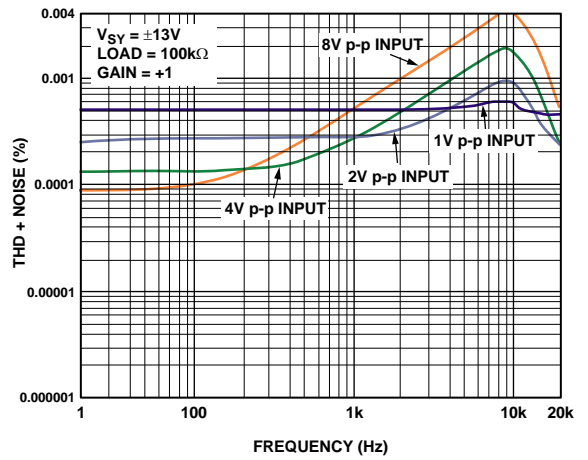

Figure 42. Total Harmonic Distortion + Noise vs. Frequency

05072-037

AD8641/AD8642/AD8643

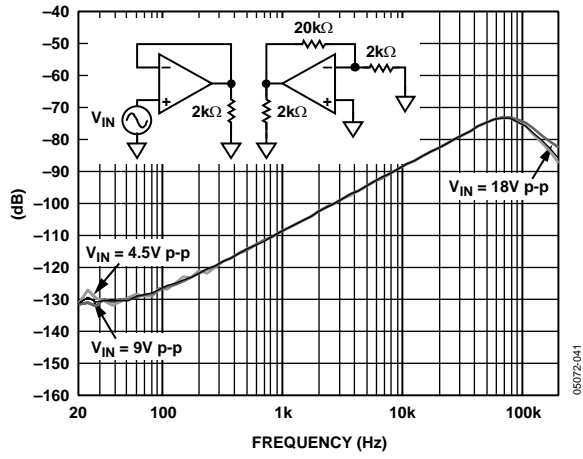

Figure 43. Channel Separation

OUTLINE DIMENSIONS

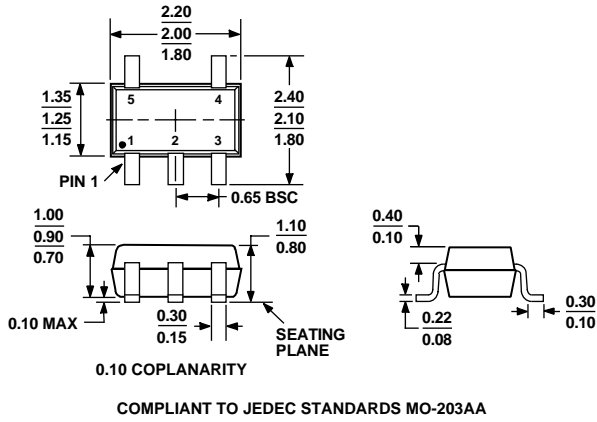

Figure 44. 5-Lead Thin Shrink Small Outline Transistor Package [SC70] (KS-5)
Dimensions shown in millimeters

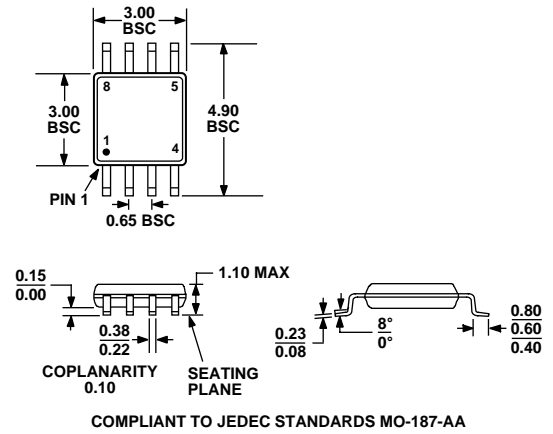

Figure 46. 8-Lead Mini Small Outline Package [MSOP] (RM-8)
Dimensions shown in millimeters

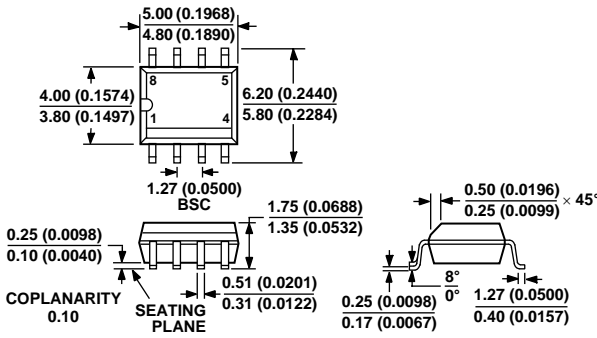

Figure 45. 8-Lead Standard Small Outline Package [SOIC_N] (R-8)
Dimensions shown in millimeters and (inches)

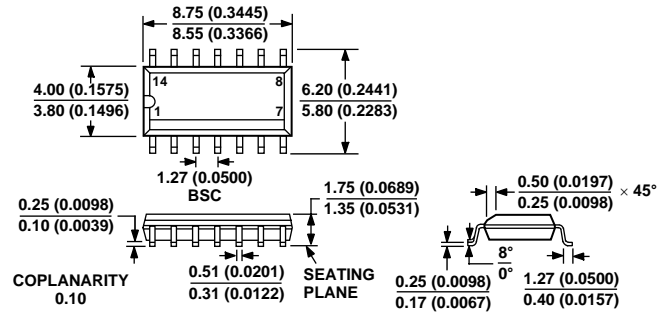
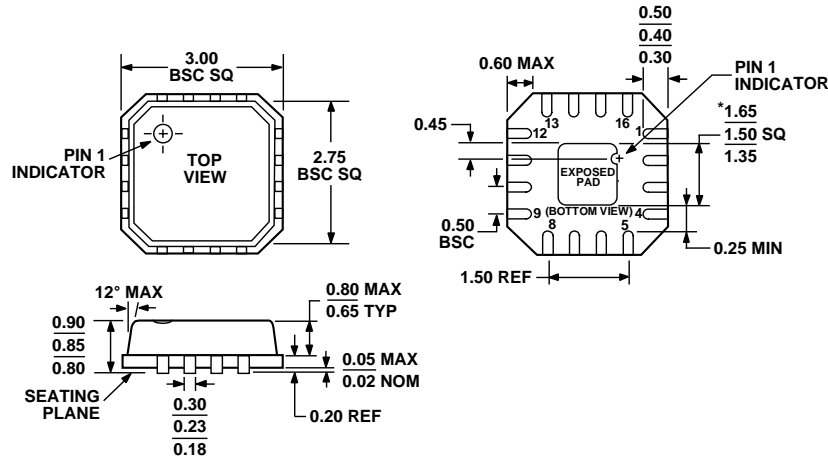

Figure 47. 14-Lead Standard Small Outline Package [SOIC_N] (R-14)
Dimensions shown in millimeters and (inches)

AD8641/AD8642/AD8643



*COMPLIANT TO JEDEC STANDARDS MO-220-VEED-2 EXCEPT FOR EXPOSED PAD DIMENSION.

Figure 48. 16-Lead Lead Frame Chip Scale Package [LFCSP_VQ]
3 mm x 3 mm Body, Very Thin Quad (CP-16-3)
Dimensions shown in millimeters

ORDERING GUIDE

Model	Temperature Range	Package Description	Package Option	Branding
AD8641AKSZ-R2 ¹	-40°C to +125°C	5-Lead SC70	KS-5	A07
AD8641AKSZ-REEL7 ¹	-40°C to +125°C	5-Lead SC70	KS-5	A07
AD8641AKSZ-REEL ¹	-40°C to +125°C	5-Lead SC70	KS-5	A07
AD8641ARZ ¹	-40°C to +125°C	8-lead SOIC_N	R-8	
AD8641ARZ-REEL7 ¹	-40°C to +125°C	8-lead SOIC_N	R-8	
AD8641ARZ-REEL ¹	-40°C to +125°C	8-lead SOIC_N	R-8	
AD8642ARMZ-R2 ¹	-40°C to +125°C	8-lead MSOP	RM-8	A0A
AD8642ARMZ-REEL ¹	-40°C to +125°C	8-lead MSOP	RM-8	A0A
AD8642ARZ ¹	-40°C to +125°C	8-lead SOIC_N	R-8	
AD8642ARZ-REEL7 ¹	-40°C to +125°C	8-lead SOIC_N	R-8	
AD8642ARZ-REEL ¹	-40°C to +125°C	8-lead SOIC_N	R-8	
AD8643ARZ ¹	-40°C to +125°C	14-lead SOIC_N	R-14	
AD8643ARZ-REEL7 ¹	-40°C to +125°C	14-lead SOIC_N	R-14	
AD8643ARZ-REEL ¹	-40°C to +125°C	14-lead SOIC_N	R-14	
AD8643ACPZ-R2 ¹	-40°C to +125°C	16-Lead LFCSP_VQ	CP-16-3	AUA
AD8643ACPZ-REEL7 ¹	-40°C to +125°C	16-Lead LFCSP_VQ	CP-16-3	AUA
AD8643ACPZ-REEL ¹	-40°C to +125°C	16-Lead LFCSP_VQ	CP-16-3	AUA

¹ Z = Pb-free part.

NOTES

AD8641/AD8642/AD8643

NOTES