

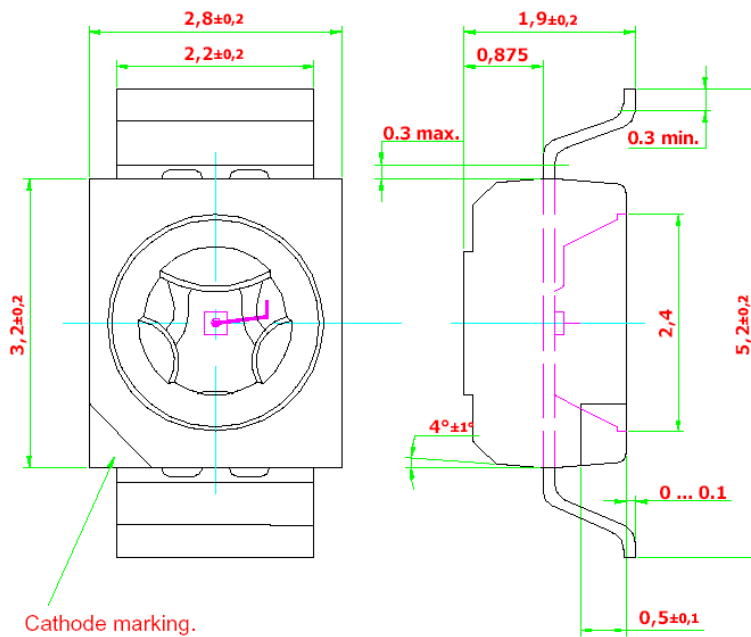

● Feature:

1. High brightness surface mount LED.
2. Based on InGaN technology.
3. 120° viewing angle.
4. Small package outline (LxWxH) of 2.8 x 3.2 x 1.8 mm.
5. Qualified according to JEDEC moisture sensitivity Level 2.
6. Compatible to both IR reflow soldering and TTW soldering.
7. RoHS compliance

● Package Dimension:



Recommended Solder Pad

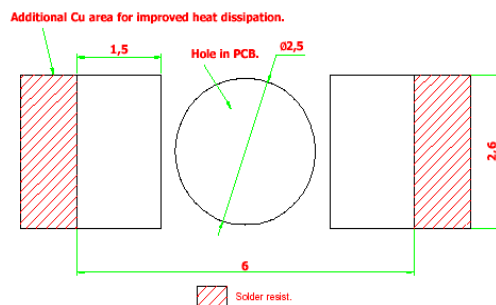
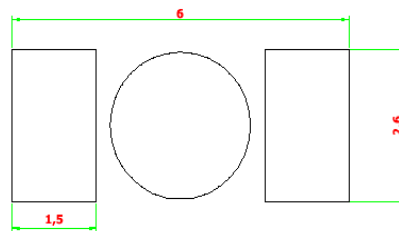



● **Optical Characteristics:**

Part Number	Chip Technology / Color	Viewing angle	Luminous Intensity @ If = 20mA Iv ( mcd )						
<b>BL-PDB-CRS-C10</b> <ul style="list-style-type: none"> <li>• BIN P1</li> <li>• BIN P2</li> <li>• BIN Q1</li> <li>• BIN Q2</li> </ul> <b>BL-PDB-SRS-C10</b> <ul style="list-style-type: none"> <li>• BIN Q1</li> <li>• BIN Q2</li> <li>• BIN R1</li> <li>• BIN R2</li> </ul> <b>BL-PDB-URS-C10</b> <ul style="list-style-type: none"> <li>• BIN R1</li> <li>• BIN R2</li> <li>• BIN S1</li> </ul>	InGaN /  Blue, 470 nm	120	<b>45.0 ... 112.5</b>  45.0 ... 56.0 56.0 ... 71.5 71.5 ... 90.0 90.0 ... 112.5  <b>71.5 ... 180.0</b>  71.5 ... 90.0 90.0 ... 112.5 112.5 ... 140.0 140.0 ... 180.0  <b>112.5 ... 224.0</b>  112.5 ... 140.0 140.0 ... 180.0 180.0 ... 224.0						
			<b>BL-PDC-CRS-C10</b> <ul style="list-style-type: none"> <li>• BIN R1</li> <li>• BIN R2</li> <li>• BIN S1</li> <li>• BIN S2</li> </ul> <b>BL-PDC-SRS-C10</b> <ul style="list-style-type: none"> <li>• BIN S1</li> <li>• BIN S2</li> <li>• BIN T1</li> <li>• BIN T2</li> </ul>	InGaN /  Cyan, 505 nm	120	<b>112.5 ... 285.0</b>  112.5 ... 140.0 140.0 ... 180.0 180.0 ... 224.0 224.0 ... 285.0  <b>180.0 ... 450.0</b>  180.0 ... 224.0 224.0 ... 285.0 285.0 ... 355.0 355.0 ... 450.0			
						<b>BL-PDT-CRS-C10</b> <ul style="list-style-type: none"> <li>• BIN R1</li> <li>• BIN R2</li> <li>• BIN S1</li> <li>• BIN S2</li> </ul> <b>BL-PDT-SRS-C10</b> <ul style="list-style-type: none"> <li>• BIN S1</li> <li>• BIN S2</li> <li>• BIN T1</li> <li>• BIN T2</li> </ul> <b>BL-PDT-URS-C10</b> <ul style="list-style-type: none"> <li>• BIN T1</li> <li>• BIN T2</li> <li>• BIN U1</li> <li>• BIN U2</li> </ul>	InGaN /  True Green, 525 nm	120	<b>112.5 ... 285.0</b>  112.5 ... 140.0 140.0 ... 180.0 180.0 ... 224.0 224.0 ... 285.0  <b>180.0 ... 450.0</b>  180.0 ... 224.0 224.0 ... 285.0 285.0 ... 355.0 355.0 ... 450.0  <b>285.0 ... 715.0</b>  285.0 ... 355.0 355.0 ... 450.0 450.0 ... 560.0 560.0 ... 715.0



Part Number	Chip Technology / Color	Viewing angle	Luminous Intensity @ If = 20mA Iv ( mcd )
<b>BL-PDW-CRD-C10</b> <ul style="list-style-type: none"><li>• BIN R1</li><li>• BIN R2</li><li>• BIN S1</li><li>• BIN S2</li></ul>	InGaN / White	120	<b>112.5 ... 285.0</b> 112.5 ... 140.0 140.0 ... 180.0 180.0 ... 224.0 224.0 ... 285.0
<b>BL-PDW-SRD-C10</b> <ul style="list-style-type: none"><li>• BIN S1</li><li>• BIN S2</li><li>• BIN T1</li><li>• BIN T2</li></ul>			<b>180.0 ... 450.0</b> 180.0 ... 224.0 224.0 ... 285.0 285.0 ... 355.0 355.0 ... 450.0
<b>BL-PDW-URD-C10</b> <ul style="list-style-type: none"><li>• BIN T1</li><li>• BIN T2</li><li>• BIN U1</li><li>• BIN U2</li></ul>			<b>285.0 ... 715.0</b> 285.0 ... 355.0 355.0 ... 450.0 450.0 ... 560.0 560.0 ... 715.0
<b>BL-PDW-URD-C20</b> <ul style="list-style-type: none"><li>• BIN U1</li><li>• BIN U2</li><li>• BIN V1</li></ul>			<b>450.0 ... 900.0</b> 450.0 ... 560.0 560.0 ... 715.0 715.0 ... 900.0

NOTE:

1. Other luminous intensity groups are also available upon request.
2. Luminous intensity is measured with an accuracy of  $\pm 11\%$ .
3. Wavelength binning is carried for all units as per the wavelength-binning table. Only one wavelength group is allowed for each reel.
4. An optional Vf binning is also available upon request. Binning scheme is as per following table.



● **Absolute Maximum Ratings:**

Parameter	Maximum Value	Unit
DC forward current.	20	mA
Peak pulse current; ( $t_p \leq 10 \mu s$ , Duty cycle = 0.005)	200	mA
Reverse voltage.	5	V
LED junction temperature.	125	°C
Operating temperature.	-40 ... +100	°C
Storage temperature.	-40 ... +100	°C
Power dissipation ( at room temperature )	85	mW

● **Vf Binning:**

Vf Bin @ 20mA	Forward voltage (V)
Standard	3.35 ... 4.25
01	3.35 ... 3.65
02	3.65 ... 3.95
03	3.95 ... 4.25

Forward voltage, Vf is measured with an accuracy of  $\pm 0.1$  V.

● **Wavelength Grouping:**

Color	Group	Wavelength distribution (nm)
BL-PDB; Blue	Full	464 - 476
	W	464 - 468
	X	468 - 472
	Y	472 - 476
BL-PDC; Cyan	Full	499 - 511
	W	499 - 503
	X	503 - 507
	Y	507 - 511
BL-PDT; True Green	Full	520 - 536
	W	520 - 524
	X	524 - 528
	Y	528 - 532
	Z	532 - 536

Wavelength is measured with an accuracy of  $\pm 1$  nm.



● **BL-PDW: White Color Grouping**

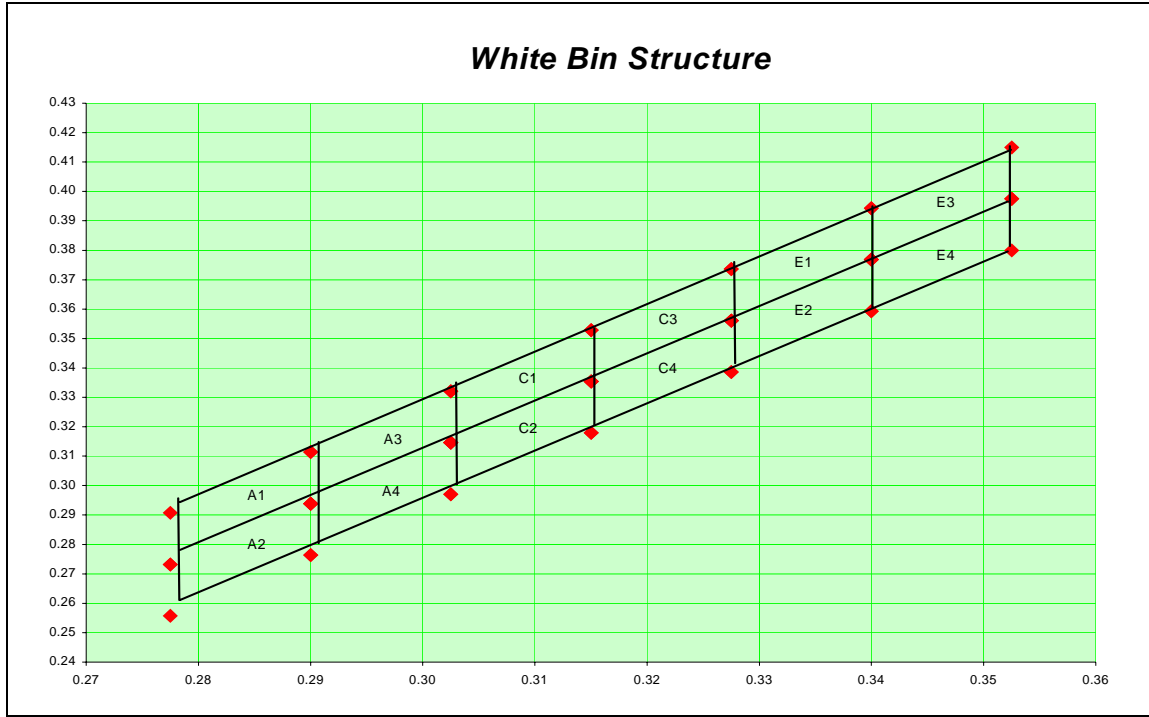

Chromaticity coordinate groups are measured with an accuracy of  $\pm 0.01$ .

W					X						
Bin		W				Bin		X			
A1	Cx	0.2775	0.2900	0.2900	0.2775	E1	Cx	0.3275	0.3400	0.3400	0.3275
	Cy	0.2732	0.2939	0.3114	0.2907		Cy	0.3561	0.3768	0.3943	0.3736
A2	Cx	0.2775	0.2900	0.2900	0.2775	E2	Cx	0.3275	0.3400	0.3400	0.3275
	Cy	0.2557	0.2764	0.2939	0.2732		Cy	0.3386	0.3593	0.3768	0.3561
A3	Cx	0.2900	0.3025	0.3025	0.2900	E3	Cx	0.3400	0.3525	0.3525	0.3400
	Cy	0.2939	0.3146	0.3321	0.3114		Cy	0.3768	0.3975	0.4150	0.3943
A4	Cx	0.2900	0.3025	0.3025	0.2900	E4	Cx	0.3400	0.3525	0.3525	0.3400
	Cy	0.2764	0.2971	0.3146	0.2939		Cy	0.3593	0.3800	0.3975	0.3768
C1	Cx	0.3025	0.3150	0.3150	0.3025						
	Cy	0.3146	0.3354	0.3529	0.3321						
C2	Cx	0.3025	0.3150	0.3150	0.3025						
	Cy	0.2971	0.3179	0.3354	0.3146						
C3	Cx	0.3150	0.3275	0.3275	0.3150						
	Cy	0.3354	0.3561	0.3736	0.3529						
C4	Cx	0.3150	0.3275	0.3275	0.3150						
	Cy	0.3179	0.3386	0.3561	0.3354						



● Typical electro-optical characteristics curves:

**Fig. 1** Relative luminous intensity vs. forward current.

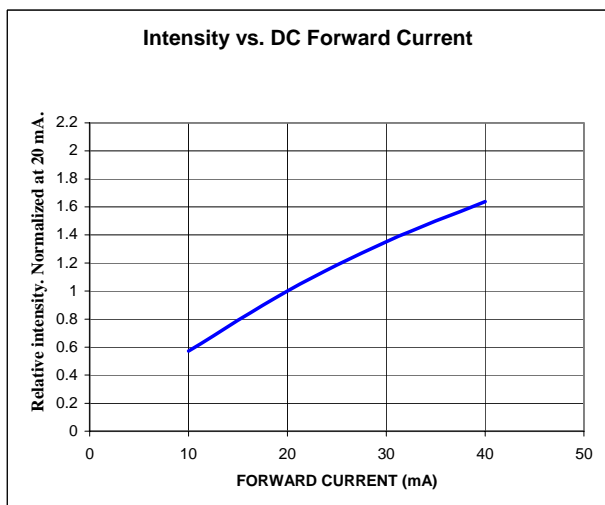

**Fig. 2** Forward current vs. forward voltage.

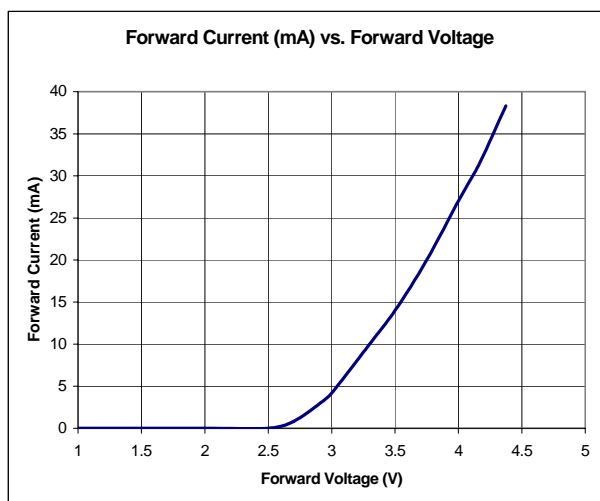

**Fig. 3** Radiation pattern.

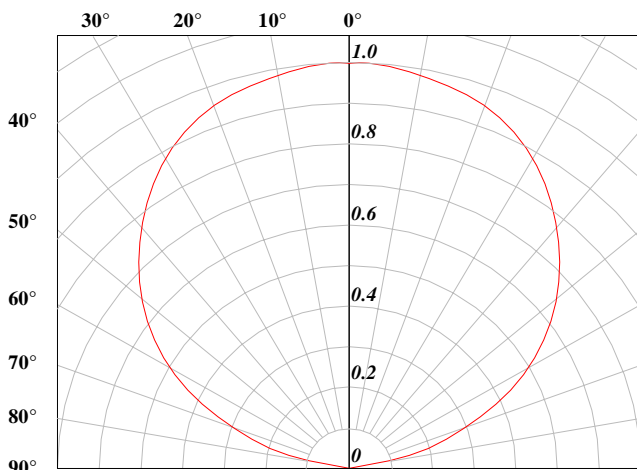

**Fig. 4** Maximum forward current vs. temperature.

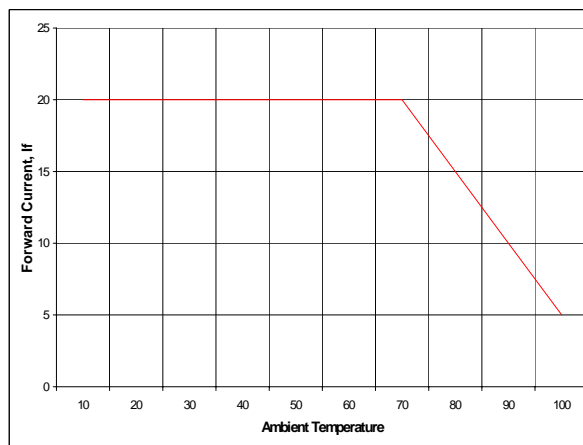

**Fig. 5** Relative Intensity vs. Wavelength

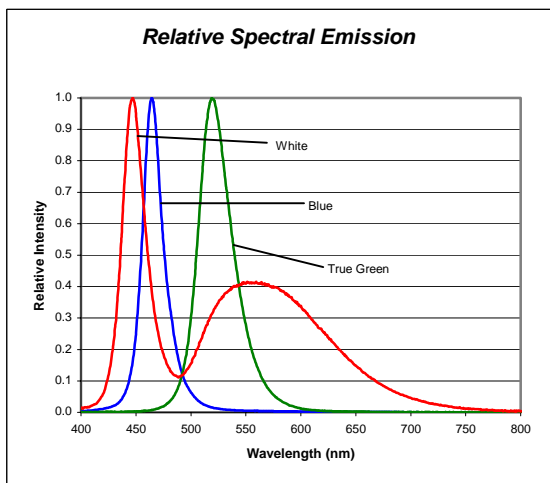

**Fig. 6** Dominant Wavelength vs. Forward Current

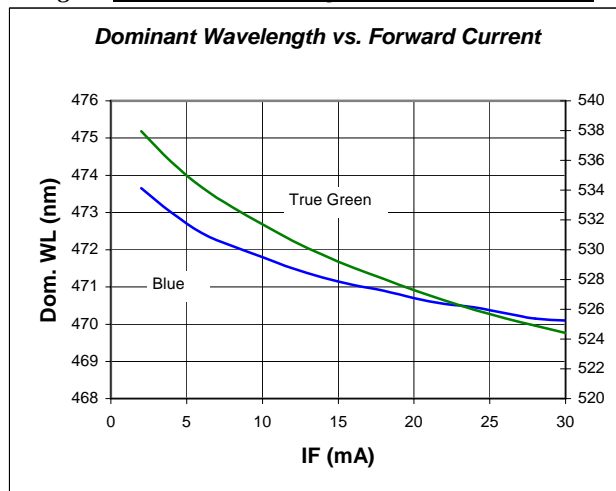



Fig. 7 Recommended IR-reflow Soldering Profile.

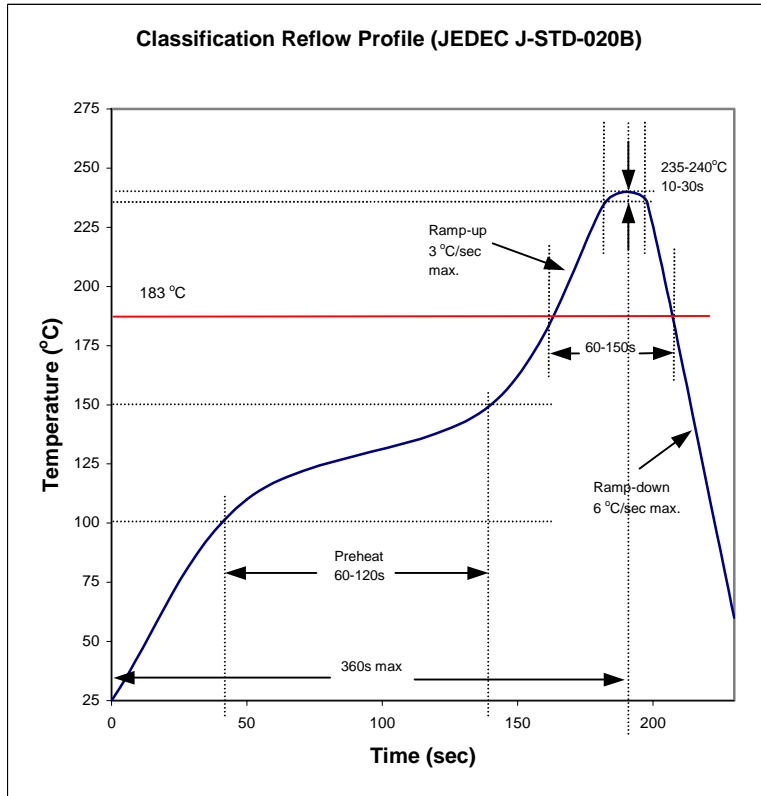
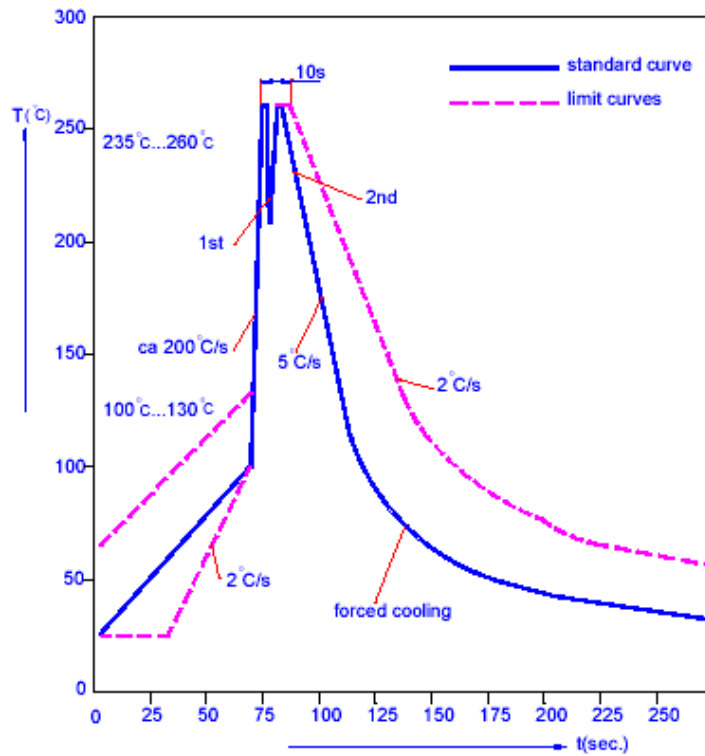

Fig. 8 Recommended TTW Soldering Profile.





● Taping And Orientation.

Reels come in quantity of 8000 units or 2000 units.

Reel diameters are 330 mm and 180 mm respectively.

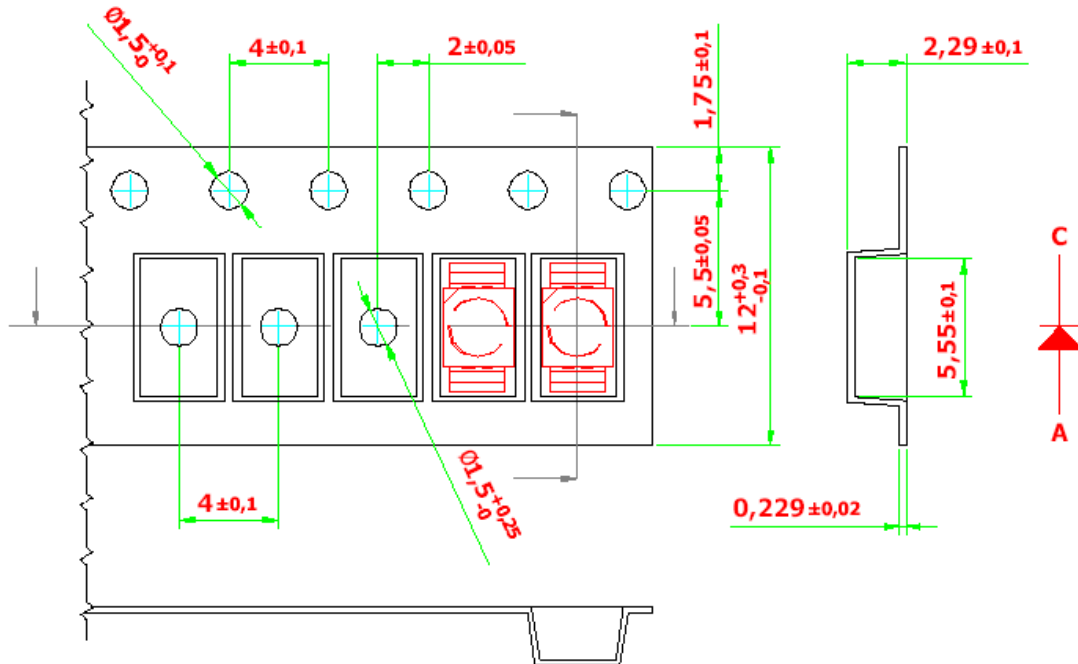

200 mm min. for  $\varnothing 180$  reel.

480 mm min. for  $\varnothing 180$  reel.

200 mm min. for  $\varnothing 330$  reel.

960 mm min. for  $\varnothing 330$  reel.

