

**TO-220**


1 2 3

**TO-252  
(DPAK)**


1 2 3

**Pin Definition:**

1. Input
2. Ground (tab)
3. Output

### General Description

The TS78M00A Series positive voltage regulators are identical to the popular TS7800A Series devices, except that they are specified for only half the output current. Like the TS7800A devices, the TS78M00A Series 3-Terminal regulators are intended for local, on-card voltage regulation.

Internal current limiting, thermal shutdown circuitry and safe-area compensation for the internal pass transistor combine to make these devices remarkably rugged under most operating conditions. Maximum output current with adequate heatsink is 500mA

This series is offered in 3-pin TO-220 & TO-252 package.

### Features

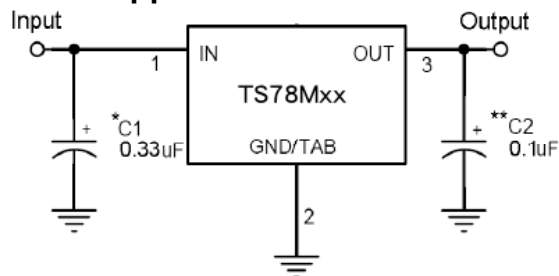
- Output Voltage Range 5 to 24V
- Output current up to 500mA
- No external components required
- Internal thermal overload protection
- Internal short-circuit current limiting
- Output transistor safe-area compensation
- Output voltage offered in 2% tolerance

### Ordering Information

Part No.	Package	Packing
TS78MxxACZ C0	TO-220	50pcs / Tube
TS78MxxACP RO	TO-252	2.5Kpcs / 13" Reel

Note: Where **xx** denote voltage option

### Standard Application Circuit



A common ground is required between the input and the output voltages. The input voltage must remain typically 2.0V above the output voltage even during the low point on the Input ripple voltage.

XX = these two digits of the type number indicate voltage.

\* = Cin is required if regulator is located an appreciable distance from power supply filter.

\*\* = Co is not needed for stability; however, it does improve transient response.

### Absolute Maximum Rating (Ta = 25°C unless otherwise noted)

Parameter	Symbol	Limit	Unit
Input Voltage	V <sub>IN</sub> *	35	V
Input Voltage	V <sub>IN</sub> **	40	V
Power Dissipation	P <sub>D</sub>	Internal Limited	W
Operating Junction Temperature	T <sub>J</sub>	0~+125	°C
Storage Temperature Range	T <sub>STG</sub>	-65~+150	°C

Note: \* TS78M05A to TS78M18A

\*\* TS78M24A

\*\*\* Follow the derating curve

### TS78M05A Electrical Characteristics

( $V_{in}=10V$ ,  $I_{out}=350mA$ ,  $0^{\circ}C \leq T_j \leq 125^{\circ}C$ ,  $C_{in}=0.33\mu F$ ,  $C_{out}=0.1\mu F$ ; unless otherwise specified.)

Parameter	Symbol	Test Condition	Min	Typ	Max	Unit	
Output voltage	Vout	$T_j=25^{\circ}C$	4.90	5	5.10	V	
		$7.5V \leq V_{in} \leq 20V$ , $5mA \leq I_{out} \leq 350mA$	4.80	5	5.20		
Line Regulation	REGline	$T_j=25^{\circ}C$	$7.5V \leq V_{in} \leq 25V$	--	3	100	mV
			$8V \leq V_{in} \leq 12V$	--	1	50	
Load Regulation	REGload	$T_j=25^{\circ}C$	$5mA \leq I_{out} \leq 500mA$	--	15	100	
			$5mA \leq I_{out} \leq 200mA$	--	5	50	
Quiescent Current	Iq	$I_{out}=0$ , $T_j=25^{\circ}C$	--	3	6	mA	
Quiescent Current Change	$\Delta Iq$	$7.5V \leq V_{in} \leq 25V$	--	--	0.8		
		$5mA \leq I_{out} \leq 350mA$	--	--	0.5		
Output Noise Voltage	Vn	$10Hz \leq f \leq 100KHz$ , $T_j=25^{\circ}C$	--	40	--	$\mu V$	
Ripple Rejection Ratio	RR	$f=120Hz$ , $8V \leq V_{in} \leq 18V$	62	78	--	dB	
Voltage Drop	Vdrop	$I_{out}=500mA$ , $T_j=25^{\circ}C$	--	2	--	V	
Output Resistance	Rout	$f=1KHz$	--	17	--	$m\Omega$	
Output Short Circuit Current	Ios	$T_j=25^{\circ}C$	--	50	--	mA	
Peak Output Current	I <sub>o peak</sub>	$T_j=25^{\circ}C$	--	0.7	--	A	
Temperature Coefficient of Output Voltage	$\Delta V_{out} / \Delta T_j$	$I_{out}=5mA$ , $0^{\circ}C \leq T_j \leq 125^{\circ}C$	--	-0.2	--	$mV / ^{\circ}C$	

### TS78M06A Electrical Characteristics

( $V_{in}=11V$ ,  $I_{out}=350mA$ ,  $0^{\circ}C \leq T_j \leq 125^{\circ}C$ ,  $C_{in}=0.33\mu F$ ,  $C_{out}=0.1\mu F$ ; unless otherwise specified.)

Parameter	Symbol	Test Condition	Min	Typ	Max	Unit	
Output Voltage	Vout	$T_j=25^{\circ}C$	5.88	6	6.12	V	
		$8.5V \leq V_{in} \leq 21V$ , $5mA \leq I_{out} \leq 350mA$	5.76	6	6.24		
Line Regulation	REGline	$T_j=25^{\circ}C$	$8.5V \leq V_{in} \leq 25V$	--	5	120	mV
			$9V \leq V_{in} \leq 13V$	--	1.5	60	
Load Regulation	REGload	$T_j=25^{\circ}C$	$5mA \leq I_{out} \leq 500mA$	--	14	120	
			$5mA \leq I_{out} \leq 200mA$	--	4	60	
Quiescent Current	Iq	$I_{out}=0$ , $T_j=25^{\circ}C$	--	3	6	mA	
Quiescent Current Change	$\Delta Iq$	$8.5V \leq V_{in} \leq 25V$	--	--	0.8		
		$5mA \leq I_{out} \leq 350mA$	--	--	0.5		
Output Noise Voltage	Vn	$10Hz \leq f \leq 100KHz$ , $T_j=25^{\circ}C$	--	45	--	$\mu V$	
Ripple Rejection Ratio	RR	$F=120Hz$ , $9V \leq V_{in} \leq 19V$	59	80	--	dB	
Voltage Drop	Vdrop	$I_{out}=500mA$ , $T_j=25^{\circ}C$	--	2	--	V	
Output Resistance	Rout	$F=1KHz$	--	19	--	$m\Omega$	
Output Short Circuit Current	Ios	$T_j=25^{\circ}C$	--	50	--	mA	
Peak Output Current	I <sub>o peak</sub>	$T_j=25^{\circ}C$	--	0.7	--	A	
Temperature Coefficient of Output Voltage	$\Delta V_{out} / \Delta T_j$	$I_{out}=5mA$ , $0^{\circ}C \leq T_j \leq 125^{\circ}C$	--	-0.2	--	$mV / ^{\circ}C$	

- Pulse testing techniques are used to maintain the junction temperature as close to the ambient temperature as possible, and thermal effects must be taken into account separately.
- This specification applies only for DC power dissipation permitted by absolute maximum ratings.

### TS78M08A Electrical Characteristics

$V_{in}=14V$ ,  $I_{out}=350mA$ ,  $0^{\circ}C \leq T_j \leq 125^{\circ}C$ ,  $C_{in}=0.33\mu F$ ,  $C_{out}=0.1\mu F$ ; unless otherwise specified.)

Parameter	Symbol	Test Condition	Min	Typ	Max	Unit	
Output voltage	Vout	$T_j=25^{\circ}C$	7.84	8	8.16	V	
		$10.5V \leq V_{in} \leq 23V$ , $5mA \leq I_{out} \leq 350mA$	7.68	8	8.32		
Line Regulation	REGline	$T_j=25^{\circ}C$	$10.5V \leq V_{in} \leq 25V$	--	6	160	mV
			$11V \leq V_{in} \leq 17V$	--	2	80	
Load Regulation	REGload	$T_j=25^{\circ}C$	$5mA \leq I_{out} \leq 500mA$	--	12	160	
			$5mA \leq I_{out} \leq 200mA$	--	4	80	
Quiescent Current	Iq	$I_{out}=0$ , $T_j=25^{\circ}C$	--	3	6	mA	
Quiescent Current Change	$\Delta Iq$	$10.5V \leq V_{in} \leq 25V$	--	--	0.8		
		$5mA \leq I_{out} \leq 350mA$	--	--	0.5		
Output Noise Voltage	Vn	$10Hz \leq f \leq 100KHz$ , $T_j=25^{\circ}C$	--	52	--	$\mu V$	
Ripple Rejection Ratio	RR	$f=120Hz$ , $11V \leq V_{in} \leq 21V$	56	80	--	dB	
Voltage Drop	Vdrop	$I_{out}=500mA$ , $T_j=25^{\circ}C$	--	2	--	V	
Output Resistance	Rout	$f=1KHz$	--	16	--	$m\Omega$	
Output Short Circuit Current	Ios	$T_j=25^{\circ}C$	--	50	--	mA	
Peak Output Current	I <sub>o peak</sub>	$T_j=25^{\circ}C$	--	0.7	--	A	
Temperature Coefficient of Output Voltage	$\Delta V_{out}/ \Delta T_j$	$I_{out}=5mA$ , $0^{\circ}C \leq T_j \leq 125^{\circ}C$	--	-0.2	--	$mV/ ^{\circ}C$	

### TS78M09A Electrical Characteristics

$V_{in}=15V$ ,  $I_{out}=350mA$ ,  $0^{\circ}C \leq T_j \leq 125^{\circ}C$ ,  $C_{in}=0.33\mu F$ ,  $C_{out}=0.1\mu F$ ; unless otherwise specified.)

Parameter	Symbol	Test Condition	Min	Typ	Max	Unit	
Output Voltage	Vout	$T_j=25^{\circ}C$	8.82	9	9.18	V	
		$11.5V \leq V_{in} \leq 23V$ , $5mA \leq I_{out} \leq 350mA$	8.64	9	9.36		
Line Regulation	REGline	$T_j=25^{\circ}C$	$11.5V \leq V_{in} \leq 26V$	--	6	180	mV
			$12V \leq V_{in} \leq 17V$	--	2	90	
Load Regulation	REGload	$T_j=25^{\circ}C$	$5mA \leq I_{out} \leq 500mA$	--	12	180	
			$5mA \leq I_{out} \leq 200mA$	--	4	90	
Quiescent Current	Iq	$I_{out}=0$ , $T_j=25^{\circ}C$	--	3	6	mA	
Quiescent Current Change	$\Delta Iq$	$11.5V \leq V_{in} \leq 26V$	--	--	0.8		
		$5mA \leq I_{out} \leq 350mA$	--	--	0.5		
Output Noise Voltage	Vn	$10Hz \leq f \leq 100KHz$ , $T_j=25^{\circ}C$	--	52	--	$\mu V$	
Ripple Rejection Ratio	RR	$f=120Hz$ , $12V \leq V_{in} \leq 22V$	55	80	--	dB	
Voltage Drop	Vdrop	$I_{out}=500mA$ , $T_j=25^{\circ}C$	--	2	--	V	
Output Resistance	Rout	$f=1KHz$	--	16	--	$m\Omega$	
Output Short Circuit Current	Ios	$T_j=25^{\circ}C$	--	50	--	mA	
Peak Output Current	I <sub>o peak</sub>	$T_j=25^{\circ}C$	--	0.7	--	A	
Temperature Coefficient of Output Voltage	$\Delta V_{out}/ \Delta T_j$	$I_{out}=5mA$ , $0^{\circ}C \leq T_j \leq 125^{\circ}C$	--	-0.2	--	$mV/ ^{\circ}C$	

- Pulse testing techniques are used to maintain the junction temperature as close to the ambient temperature as possible, and thermal effects must be taken into account separately.
- This specification applies only for DC power dissipation permitted by absolute maximum ratings.

# TS78M00A Series

## 3-Terminal 500mA Positive Voltage Regulator

### TS78M12A Electrical Characteristics

( $V_{in}=19V$ ,  $I_{out}=350mA$ ,  $0^{\circ}C \leq T_j \leq 125^{\circ}C$ ,  $C_{in}=0.33\mu F$ ,  $C_{out}=0.1\mu F$ ; unless otherwise specified.)

Parameter	Symbol	Test Condition	Min	Typ	Max	Unit	
Output Voltage	Vout	$T_j=25^{\circ}C$	11.76	12	12.24	V	
		$14.5V \leq V_{in} \leq 27V$ , $5mA \leq I_{out} \leq 350mA$	11.52	12	12.48		
Line Regulation	REGline	$T_j=25^{\circ}C$	$14.5V \leq V_{in} \leq 30V$	--	10	240	mV
			$15V \leq V_{in} \leq 19V$	--	3	120	
Load Regulation	REGload	$T_j=25^{\circ}C$	$5mA \leq I_{out} \leq 500mA$	--	12	240	
			$5mA \leq I_{out} \leq 200mA$	--	4	120	
Quiescent Current	Iq	$T_j=25^{\circ}C$ , $I_{out}=0$	--	3	6	mA	
Quiescent Current Change	$\Delta Iq$	$14.5V \leq V_{in} \leq 30V$	--	--	0.8		
		$5mA \leq I_{out} \leq 500mA$	--	--	0.5		
Output Noise Voltage	Vn	$10Hz \leq f \leq 100KHz$ , $T_j=25^{\circ}C$	--	75	--	$\mu V$	
Ripple Rejection Ratio	RR	$f=120Hz$ , $15V \leq V_{in} \leq 25V$	55	80	--	dB	
Voltage Drop	Vdrop	$I_{out}=500mA$ , $T_j=25^{\circ}C$	--	2	--	V	
Output Resistance	Rout	$f=1KHz$	--	18	--	$m\Omega$	
Output Short Circuit Current	Ios	$T_j=25^{\circ}C$	--	50	--	mA	
Peak Output Current	I <sub>o peak</sub>	$T_j=25^{\circ}C$	--	0.7	--	A	
Temperature Coefficient of Output Voltage	$\Delta V_{out} / \Delta T_j$	$I_{out}=5mA$ , $0^{\circ}C \leq T_j \leq 125^{\circ}C$	--	-0.3	--	$mV / ^{\circ}C$	

### TS78M15A Electrical Characteristics

( $V_{in}=23V$ ,  $I_{out}=350mA$ ,  $0^{\circ}C \leq T_j \leq 125^{\circ}C$ ,  $C_{in}=0.33\mu F$ ,  $C_{out}=0.1\mu F$ ; unless otherwise specified.)

Parameter	Symbol	Test Condition	Min	Typ	Max	Unit	
Output voltage	Vout	$T_j=25^{\circ}C$	14.70	15	15.30	V	
		$17.5V \leq V_{in} \leq 30V$ , $5mA \leq I_{out} \leq 350mA$	14.40	15	15.60		
Line Regulation	REGline	$T_j=25^{\circ}C$	$17.5V \leq V_{in} \leq 30V$	--	12	300	mV
			$18V \leq V_{in} \leq 22V$	--	3	150	
Load Regulation	REGload	$T_j=25^{\circ}C$	$5mA \leq I_{out} \leq 500mA$	--	12	300	
			$5mA \leq I_{out} \leq 200mA$	--	4	150	
Quiescent Current	Iq	$T_j=25^{\circ}C$ , $I_{out}=0$	--	3	6	mA	
Quiescent Current Change	$\Delta Iq$	$17.5V \leq V_{in} \leq 30V$	--	--	0.8		
		$5mA \leq I_{out} \leq 500mA$	--	--	0.5		
Output Noise Voltage	Vn	$10Hz \leq f \leq 100KHz$ , $T_j=25^{\circ}C$	--	90	--	$\mu V$	
Ripple Rejection Ratio	RR	$f=120Hz$ , $18V \leq V_{in} \leq 28V$	54	80	--	dB	
Voltage Drop	Vdrop	$I_{out}=500mA$ , $T_j=25^{\circ}C$	--	2	--	V	
Output Resistance	Rout	$f=1KHz$	--	19	--	$m\Omega$	
Output Short Circuit Current	Ios	$T_j=25^{\circ}C$	--	50	--	mA	
Peak Output Current	I <sub>o peak</sub>	$T_j=25^{\circ}C$	--	0.7	--	A	
Temperature Coefficient of Output Voltage	$\Delta V_{out} / \Delta T_j$	$I_{out}=10mA$ , $0^{\circ}C \leq T_j \leq 125^{\circ}C$	--	-0.3	--	$mV / ^{\circ}C$	

- Pulse testing techniques are used to maintain the junction temperature as close to the ambient temperature as possible, and thermal effects must be taken into account separately.
- This specification applies only for DC power dissipation permitted by absolute maximum ratings.

### TS78M18A Electrical Characteristics

( $V_{in}=24V$ ,  $I_{out}=350mA$ ,  $0^{\circ}C \leq T_j \leq 125^{\circ}C$ ,  $C_{in}=0.33\mu F$ ,  $C_{out}=0.1\mu F$ ; unless otherwise specified.)

Parameter	Symbol	Test Condition	Min	Typ	Max	Unit	
Output Voltage	Vout	Tj=25°C	17.64	18	18.36	V	
		21V ≤ Vin ≤ 33V, 5mA ≤ Iout ≤ 350mA	17.28	18	18.72		
Line Regulation	REGline	Tj=25°C	21V ≤ Vin ≤ 33V	--	15	360	mV
			22V ≤ Vin ≤ 26V	--	5	180	
Load Regulation	REGload	Tj=25°C	5mA ≤ Iout ≤ 500mA	--	12	360	
			5mA ≤ Iout ≤ 200mA	--	4	180	
Quiescent Current	Iq	Tj=25°C, Iout=0	--	3	6	mA	
Quiescent Current Change	ΔIq	21V ≤ Vin ≤ 33V	--	--	0.8		
		5mA ≤ Iout ≤ 500mA	--	--	0.5		
Output Noise Voltage	Vn	10Hz ≤ f ≤ 100KHz, Tj=25°C	--	110	--	μV	
Ripple Rejection Ratio	RR	f=120Hz, 21V ≤ Vin ≤ 31V	54	80	--	dB	
Voltage Drop	Vdrop	Iout=500mA, Tj=25°C	--	2	--	V	
Output Resistance	Rout	f=1KHz	--	22	--	mΩ	
Output Short Circuit Current	Ios	Tj=25°C	--	50	--	mA	
Peak Output Current	I <sub>o peak</sub>	Tj=25°C	--	0.7	--	A	
Temperature Coefficient of Output Voltage	ΔVout/ ΔTj	Iout= 5mA, 0°C ≤ Tj ≤ 125°C	--	-0.5	--	mV/ °C	

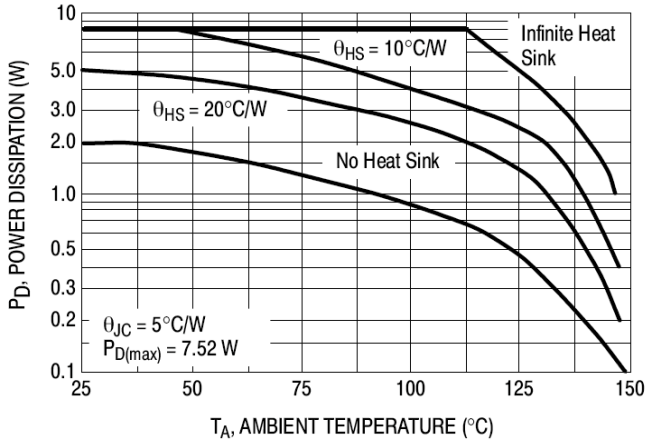
### TS78M24A Electrical Characteristics

( $V_{in}=33V$ ,  $I_{out}=350mA$ ,  $0^{\circ}C \leq T_j \leq 125^{\circ}C$ ,  $C_{in}=0.33\mu F$ ,  $C_{out}=0.1\mu F$ ; unless otherwise specified.)

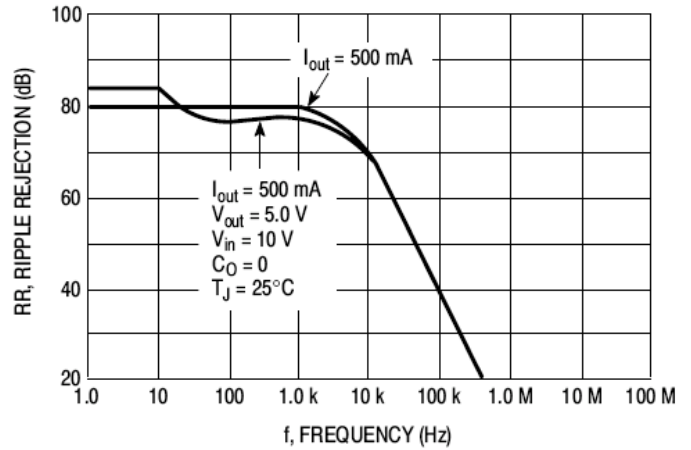
Parameter	Symbol	Test Condition	Min	Typ	Max	Unit	
Output voltage	Vout	Tj=25°C	23.52	24	24.48	V	
		27V ≤ Vin ≤ 38V, 5mA ≤ Iout ≤ 350mA	23.07	24	25.96		
Line Regulation	REGline	Tj=25°C	27V ≤ Vin ≤ 38V	--	18	480	mV
			28V ≤ Vin ≤ 32V	--	6	240	
Load Regulation	REGload	Tj=25°C	5mA ≤ Iout ≤ 500mA	--	12	480	
			5mA ≤ Iout ≤ 200mA	--	4	240	
Quiescent Current	Iq	Iout=0, Tj=25°C	--	3	6	mA	
Quiescent Current Change	ΔIq	27V ≤ Vin ≤ 38V	--	--	0.8		
		5mA ≤ Iout ≤ 500mA	--	--	0.5		
Output Noise Voltage	Vn	10Hz ≤ f ≤ 100KHz, Tj=25°C	--	170	--	μV	
Ripple Rejection Ratio	RR	f=120Hz, 27V ≤ Vin ≤ 37V	54	80	--	dB	
Voltage Drop	Vdrop	Iout=500mA, Tj=25°C	--	2	--	V	
Output Resistance	Rout	f=1KHz	--	28	--	mΩ	
Output Short Circuit Current	Ios	Tj=25°C	--	50	--	mA	
Peak Output Current	I <sub>o peak</sub>	Tj=25°C	--	0.7	--	A	
Temperature Coefficient of Output Voltage	ΔVout/ ΔTj	Iout= 5mA, 0°C ≤ Tj ≤ 125°C	--	-0.5	--	mV/ °C	

- Pulse testing techniques are used to maintain the junction temperature as close to the ambient temperature as possible, and thermal effects must be taken into account separately.
- This specification applies only for DC power dissipation permitted by absolute maximum ratings.

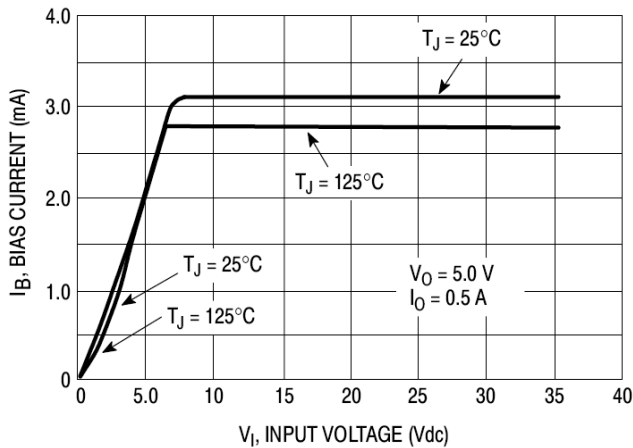
### Electrical Characteristics Curve



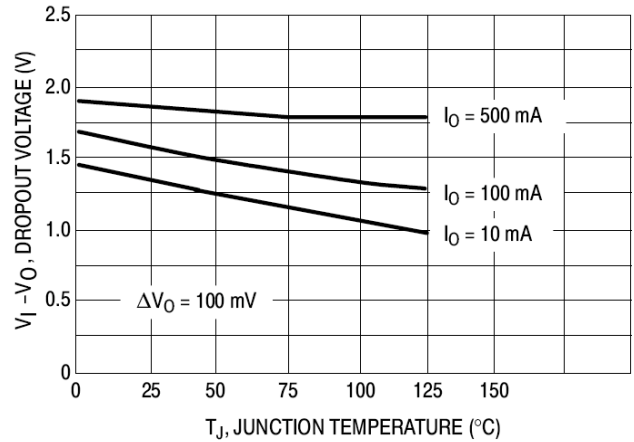
**Figure 1. Worst Case Power Dissipation vs. Ambient Temperature (TO-220)**



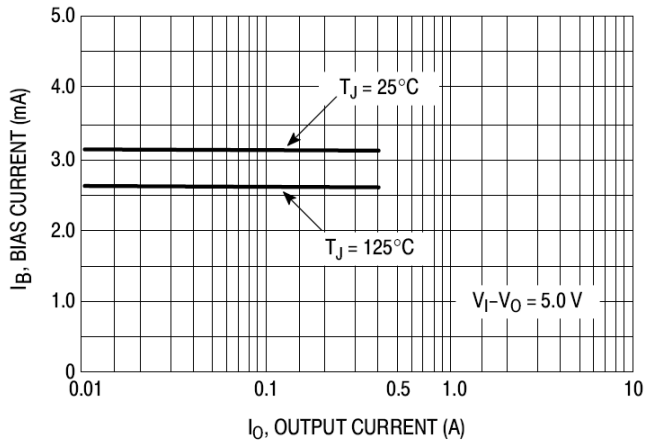
**Figure 3. Ripple Rejection vs. Frequency**



**Figure 3. Bias Current vs. Input Voltage**

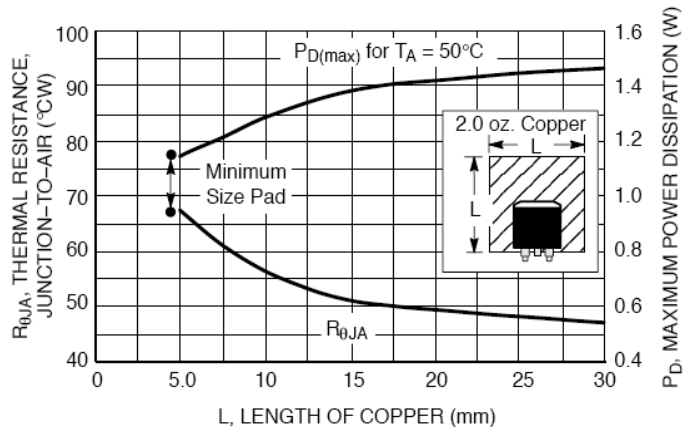


**Figure 4. Dropout Voltage vs. Junction Temperature**



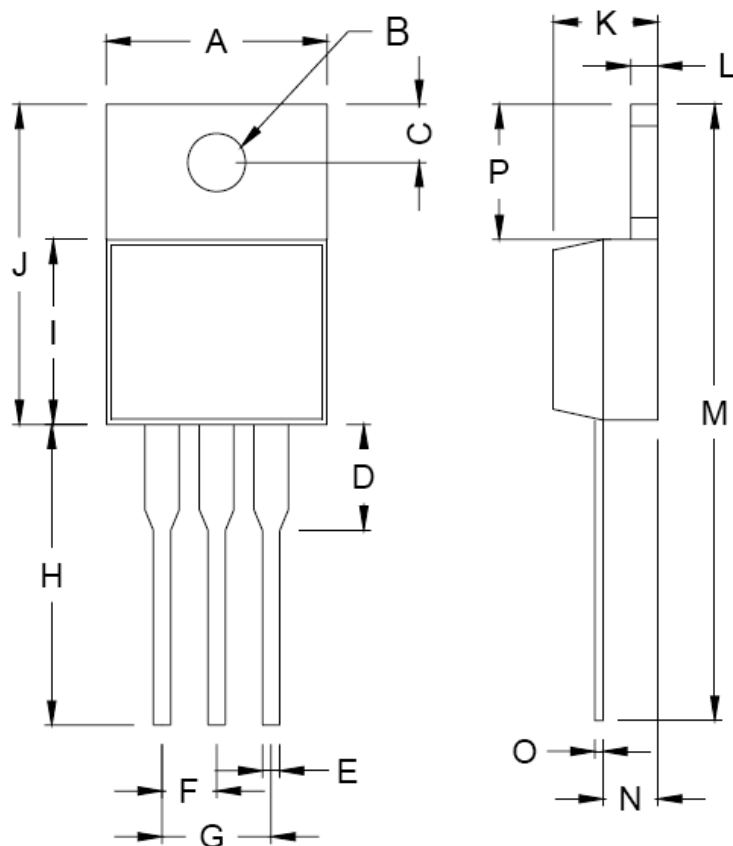
**Figure 5. Bias Current vs. Output Current**

### Application information



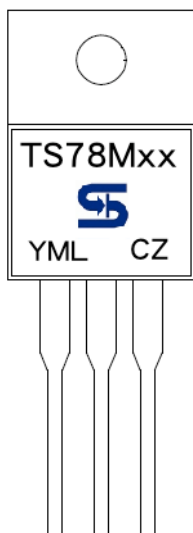
**Figure 7. DPAK Thermal Resistance and Maximum Power Dissipation vs. P.C.B Copper Length**

### TO-220 Mechanical Drawing



TO-220 DIMENSION				
DIM	MILLIMETERS		INCHES	
	MIN	MAX	MIN	MAX
A	10.000	10.500	0.394	0.413
B	3.740	3.910	0.147	0.154
C	2.440	2.940	0.096	0.116
D	-	6.350	-	0.250
E	0.381	1.106	0.015	0.040
F	2.345	2.715	0.092	0.058
G	4.690	5.430	0.092	0.107
H	12.700	14.732	0.500	0.581
I	8.382	9.017	0.330	0.355
J	14.224	16.510	0.560	0.650
K	3.556	4.826	0.140	0.190
L	0.508	1.397	0.020	0.055
M	27.700	29.620	1.060	1.230
N	2.032	2.921	0.080	0.115
O	0.255	0.610	0.010	0.024
P	5.842	6.858	0.230	0.270

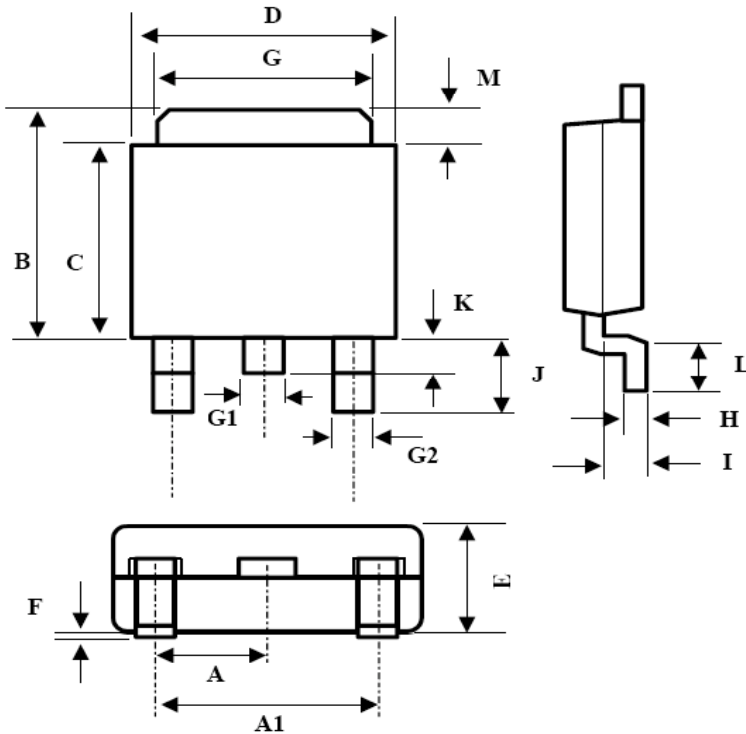
### Marking Diagram



- XX** = Output Voltage  
(05=5V, 08=8V, 09=9V, 12=12V, 15=15V, 18=18V, 24=24V)
- Y** = Year Code
- M** = Month Code  
(A=Jan, B=Feb, C=Mar, D=Apr, E=May, F=Jun, G=Jul, H=Aug, I=Sep, J=Oct, K=Nov, L=Dec)
- L** = Lot Code
- CZ** = Package Code for TO-220

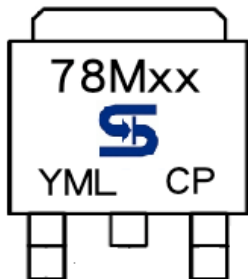


### TO-252 Mechanical Drawing



DIM	TO-252 DIMENSION			
	MILLIMETERS		INCHES	
	MIN	MAX	MIN	MAX
A	2.3BSC		0.09BSC	
A1	4.6BSC		0.18BSC	
B	6.80	7.20	0.268	0.283
C	5.40	5.60	0.213	0.220
D	6.40	6.65	0.252	0.262
E	2.20	2.40	0.087	0.094
F	0.00	0.20	0.000	0.008
G	5.20	5.40	0.205	0.213
G1	0.75	0.85	0.030	0.033
G2	0.55	0.65	0.022	0.026
H	0.35	0.65	0.014	0.026
I	0.90	1.50	0.035	0.059
J	2.20	2.80	0.087	0.110
K	0.50	1.10	0.020	0.043
L	0.90	1.50	0.035	0.059
M	1.30	1.70	0.051	0.67

### Marking Diagram



- XX** = Output Voltage  
(05=5V, 08=8V, 09=9V, 12=12V, 15=15V, 18=18V, 24=24V)
- Y** = Year Code
- M** = Month Code  
(**A**=Jan, **B**=Feb, **C**=Mar, **D**=Apr, **E**=May, **F**=Jun, **G**=Jul, **H**=Aug, **I**=Sep, **J**=Oct, **K**=Nov, **L**=Dec)
- L** = Lot Code
- CP** = Package Code for TO-252

# TS78M00A Series

## 3-Terminal 500mA Positive Voltage Regulator

### Notice

Specifications of the products displayed herein are subject to change without notice. TSC or anyone on its behalf, assumes no responsibility or liability for any errors or inaccuracies.

Information contained herein is intended to provide a product description only. No license, express or implied, to any intellectual property rights is granted by this document. Except as provided in TSC's terms and conditions of sale for such products, TSC assumes no liability whatsoever, and disclaims any express or implied warranty, relating to sale and/or use of TSC products including liability or warranties relating to fitness for a particular purpose, merchantability, or infringement of any patent, copyright, or other intellectual property right.

The products shown herein are not designed for use in medical, life-saving, or life-sustaining applications. Customers using or selling these products for use in such applications do so at their own risk and agree to fully indemnify TSC for any damages resulting from such improper use or sale.