

Positive Voltage Regulators for Voltage Reference Source

■ GENERAL DESCRIPTION

The XC62RP series are highly precise, low power consumption, positive voltage regulators, for voltage reference source, manufactured using CMOS and laser trimming technologies.

SOT-23 (150mW), SOT-89 (500mW) and TO-92 (300mW) packages are available.

■ APPLICATIONS

- Battery powered equipment
- Reference voltage sources
- Cameras and video recorders
- Palmtops

■ FEATURES

- Maximum Output Current** : 6.0mA (within max. power dissipation, $V_{OUT}=2.0V$)
- Output Voltage Range** : 1.5V ~ 3.5V in 100mV increments
- Highly Accurate** : Setting Voltage accuracy $\pm 2\%$ ($\pm 1\%$ for semi-custom products)
- Low Power Consumption** : $3.2 \mu A$ ($V_{OUT}=2.0$) (TYP.)
- Output Voltage Temperature Characteristics** : $\pm 100\text{ppm}/^\circ\text{C}$ (TYP.)
- Line Regulation** : $0.2\%/V$ (TYP.)
- CMOS Low Power Consumption**
- Dropout Voltage** : $140\text{mV} @ 300\mu A$
- Ultra Small Packages** : SOT-23 (150mW) mini-mold
SOT-89 (500mW) mini-power mold
TO-92 (300mW)

■ TYPICAL APPLICATION CIRCUIT

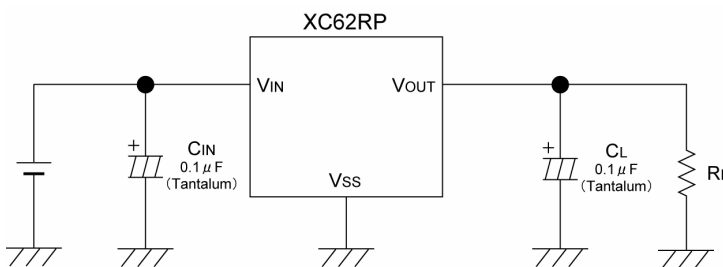

Please use with a load capacitance (C_L) of less than $0.1 \mu F$.

■ TYPICAL PERFORMANCE CHARACTERISTICS

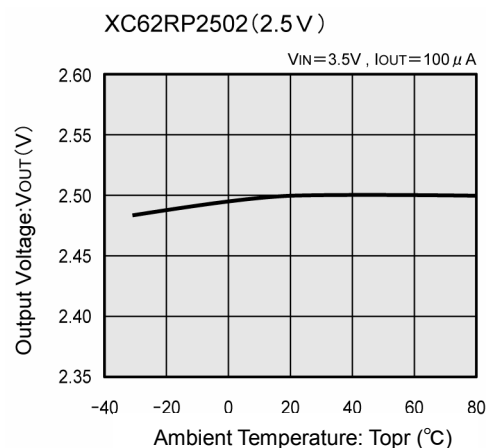

PIN CONFIGURATION

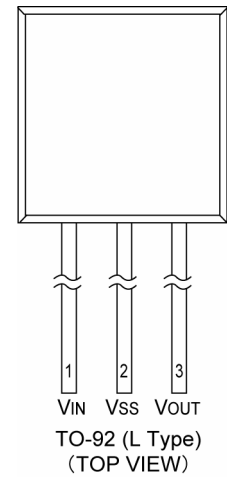
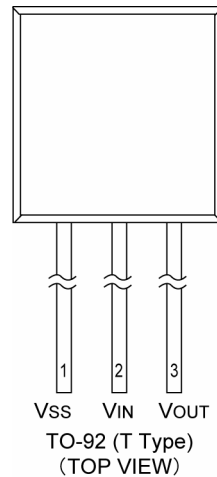
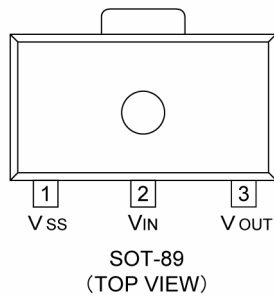
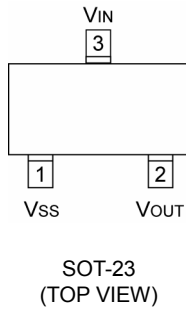

PIN ASSIGNMENT

PIN NUMBER				PIN NAME	FUNCTION
SOT-23	SOT-89	TO-92 (T)	TO-92 (L)		
1	1	1	2	Vss	Ground
3	2	2	1	VIN	Supply Voltage Input
2	3	3	3	VOUT	Output

PRODUCT CLASSIFICATION

Ordering Information

XC62R ①②③④⑤⑥⑦

DESIGNATOR	DESCRIPTION	SYMBOL	DESCRIPTION
①	Polarity of Output Voltage	P	: Positive
② ③	Output Voltage	15 ~ 35	: e.g. Vout1.5V→②=1, ③=5 Vout3.0V→②=3, ③=0
④	Temperature Coefficients	0	: ±100ppm (TYP.)
⑤	Output Voltage Accuracy	1	: ±1% (Semi-custom)
		2	: ±2%
⑥	Package	M	: SOT-23
		P	: SOT-89
		T	: TO-92 (standard)
		L	: TO-92 (Custom pin configuration)
⑦	Device Orientation	R	: Embossed tape, standard feed
		L	: Embossed tape, reverse feed
		H	: Paper tape (TO-92)
		B	: Bag (TO-92)

■ BLOCK DIAGRAM

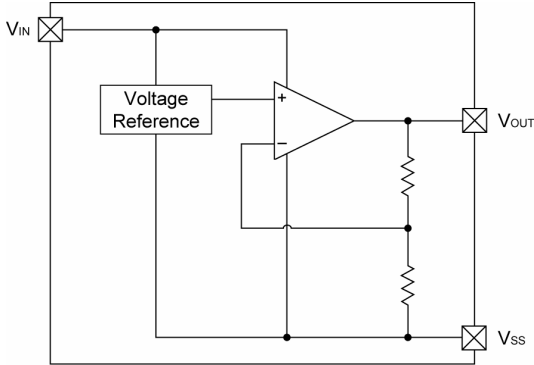

■ ABSOLUTE MAXIMUM RATINGS

Ta=25°C

PARAMETER	SYMBOL	RATINGS	UNITS
Input Voltage	V _{IN}	12.0	V
Output Current	I _{OUT}	50*	mA
Output Voltage	V _{OUT}	V _{SS} -0.3~V _{IN} +0.3	V
Power Dissipation	SOT-23	150	mW
	SOT-89	500	
	TO-92	300	
Operating Temperature Range	T _{opr}	-30 ~ +80	°C
Storage Temperature Range	T _{stg}	-40 ~ +125	°C

Note: Please ensure that I_{OUT} is less than Pd / (V_{IN}-V_{OUT}).

ELECTRICAL CHARACTERISTICS

XC62RP1602 $V_{OUT(T)}=1.6V$ (*1)

$T_a=25^{\circ}C$

PARAMETER	SYMBOL	CONDITIONS	MIN.	TYP.	MAX.	UNITS	CIRCUIT
Output Voltage	$V_{OUT(E)}$ (*2)	$I_{OUT}=100\mu A$ $V_{IN}=2.6V$	1.568	1.600	1.632	V	1
Maximum Output Current	$I_{OUT\ max}$	$V_{IN}=2.6V$, $V_{OUT(E)}\geq V_{OUT(T)}\times 0.95$	4.0	-	-	mA	1
Load Regulation	ΔV_{OUT}	$V_{IN}=2.6V$ $100\mu A\leq I_{OUT}\leq 300\mu A$	-	20	40	mV	1
Dropout Voltage (*3)	V_{dif1}	$I_{OUT}=100\mu A$	-	30	80	mV	1
	V_{dif2}	$I_{OUT}=300\mu A$	-	50	140	mV	1
Supply Current	I_{SS}	$V_{IN}=2.6V$	-	3.0	5.8	μA	2
Line Regulation	$\frac{\Delta V_{OUT}}{\Delta V_{IN} \cdot V_{OUT}}$	$I_{OUT}=100\mu A$ $2.6V\leq V_{IN}\leq 6.0V$	-	0.2	0.3	%/V	1
Input Voltage	V_{IN}		-	-	6.0	V	-
Output Voltage Temperature Characteristics	$\frac{\Delta V_{OUT}}{\Delta T_{opr} \cdot V_{OUT}}$	$I_{OUT}=100\mu A$ $-30^{\circ}C\leq T_{opr}\leq 80^{\circ}C$	-	± 100	-	ppm/ $^{\circ}C$	1

XC62RP2002 $V_{OUT(T)}=2.0V$ (*1)

$T_a=25^{\circ}C$

PARAMETER	SYMBOL	CONDITIONS	MIN.	TYP.	MAX.	UNITS	CIRCUIT
Output Voltage	$V_{OUT(E)}$ (*2)	$I_{OUT}=100\mu A$ $V_{IN}=3.0V$	1.960	2.000	2.040	V	1
Maximum Output Current	$I_{OUT\ max}$	$V_{IN}=3.0V$, $V_{OUT(E)}\geq V_{OUT(T)}\times 0.95$	6.0	-	-	mA	1
Load Regulation	ΔV_{OUT}	$V_{IN}=3.0V$ $100\mu A\leq I_{OUT}\leq 300\mu A$	-	20	40	mV	1
Dropout Voltage (*3)	V_{dif1}	$I_{OUT}=100\mu A$	-	30	80	mV	1
	V_{dif2}	$I_{OUT}=300\mu A$	-	50	140	mV	1
Supply Current	I_{SS}	$V_{IN}=3.0V$	-	3.2	6.2	μA	2
Line Regulation	$\frac{\Delta V_{OUT}}{\Delta V_{IN} \cdot V_{OUT}}$	$I_{OUT}=100\mu A$ $3.0V\leq V_{IN}\leq 6.0V$	-	0.2	0.3	%/V	1
Input Voltage	V_{IN}		-	-	6.0	V	-
Output Voltage Temperature Characteristics	$\frac{\Delta V_{OUT}}{\Delta T_{opr} \cdot V_{OUT}}$	$I_{OUT}=100\mu A$ $-30^{\circ}C\leq T_{opr}\leq 80^{\circ}C$	-	± 100	-	ppm/ $^{\circ}C$	1

■ ELECTRICAL CHARACTERISTICS (Continued)

XC62RP2502 $V_{OUT(T)}=2.5V$ (*1)

$T_a=25^{\circ}C$

PARAMETER	SYMBOL	CONDITIONS	MIN.	TYP.	MAX.	UNITS	CIRCUIT
Output Voltage	$V_{OUT(E)}$ (*2)	$I_{OUT}=100\mu A$ $V_{IN}=3.5V$	2.450	2.500	2.550	V	1
Maximum Output Current	$I_{OUT\ max}$	$V_{IN}=3.5V$, $V_{OUT(E)}\geq V_{OUT(T)}\times 0.95$	8.0	-	-	mA	1
Load Regulation	ΔV_{OUT}	$V_{IN}=3.5V$ $100\mu A\leq I_{OUT}\leq 300\mu A$	-	20	40	mV	1
Dropout Voltage (*3)	Vdif1	$I_{OUT}=100\mu A$	-	30	80	mV	1
	Vdif2	$I_{OUT}=300\mu A$	-	50	140	mV	1
Supply Current	I_{SS}	$V_{IN}=3.5V$	-	3.5	6.8	μA	2
Line Regulation	$\frac{\Delta V_{OUT}}{\Delta V_{IN}\cdot V_{OUT}}$	$I_{OUT}=100\mu A$ $3.5V\leq V_{IN}\leq 6.0V$	-	0.2	0.3	%/V	1
Input Voltage	V_{IN}		-	-	6.0	V	-
Output Voltage Temperature Characteristics	$\frac{\Delta V_{OUT}}{\Delta T_{opr}\cdot V_{OUT}}$	$I_{OUT}=100\mu A$ $-30^{\circ}C\leq T_{opr}\leq 80^{\circ}C$	-	± 100	-	ppm/ $^{\circ}C$	1

XC62RP3002 $V_{OUT(T)}=3.0V$ (*1)

$T_a=25^{\circ}C$

PARAMETER	SYMBOL	CONDITIONS	MIN.	TYP.	MAX.	UNITS	CIRCUIT
Output Voltage	$V_{OUT(E)}$ (*2)	$I_{OUT}=100\mu A$ $V_{IN}=4.0V$	2.940	3.000	3.060	V	1
Maximum Output Current	$I_{OUT\ max}$	$V_{IN}=4.0V$, $V_{OUT(E)}\geq V_{OUT(T)}\times 0.95$	10.0	-	-	mA	1
Load Regulation	ΔV_{OUT}	$V_{IN}=4.0V$ $100\mu A\leq I_{OUT}\leq 300\mu A$	-	20	40	mV	1
Dropout Voltage (*3)	Vdif1	$I_{OUT}=100\mu A$	-	30	80	mV	1
	Vdif2	$I_{OUT}=300\mu A$	-	50	140	mV	1
Supply Current	I_{SS}	$V_{IN}=4.0V$	-	3.8	7.3	μA	2
Line Regulation	$\frac{\Delta V_{OUT}}{\Delta V_{IN}\cdot V_{OUT}}$	$I_{OUT}=100\mu A$ $4.0V\leq V_{IN}\leq 6.0V$	-	0.2	0.3	%/V	1
Input Voltage	V_{IN}		-	-	6.0	V	-
Output Voltage Temperature Characteristics	$\frac{\Delta V_{OUT}}{\Delta T_{opr}\cdot V_{OUT}}$	$I_{OUT}=100\mu A$ $-30^{\circ}C\leq T_{opr}\leq 80^{\circ}C$	-	± 100	-	ppm/ $^{\circ}C$	1

NOTE:

*1: $V_{OUT(T)}$ =Specified output voltage .

*2: $V_{OUT(E)}$ =Effective output voltage (i.e. the output voltage when " $V_{OUT(T)}+1.0V$ " is provided at the V_{IN} pin while maintaining a certain I_{OUT} value).

*3: $V_{dif}=\{V_{IN1}^{(*5)}-V_{OUT1}^{(*4)}\}$

*4: V_{OUT1} = A voltage equal to 98% of the output voltage whenever an amply stabilized I_{OUT} ($V_{OUT(T)}+1.0V$) is input.

*5: V_{IN1} = The input voltage when V_{OUT1} appears as input voltage is gradually decreased.

■ TYPICAL APPLICATION CIRCUIT

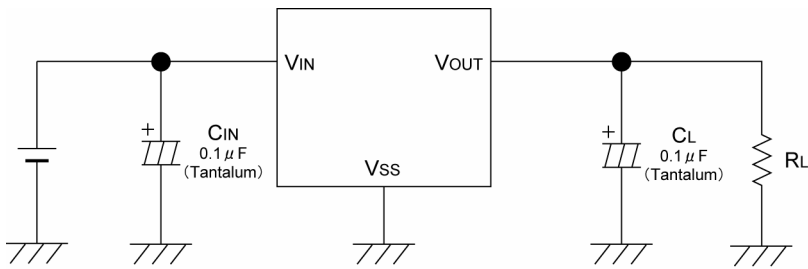

Please use with a load capacitance (C_L) of less than $0.1 \mu F$.

■ NOTES ON USE

1. Please use with a load capacitance, C_L , of less than $0.1 \mu F$ and in $0.01 \mu F$ steps.
2. Since short-circuit protection is not built-in, the IC may be damaged by rush current should the output pin be connected to the Ground pin.
3. When the load capacitance, C_L , is small, overshoot will be produced when the power is switched on.
4. As the output pin's current is only a few μA , output voltage will increase should output be pulled-up by means of a resistor.

■ TEST CIRCUITS

Circuit 1

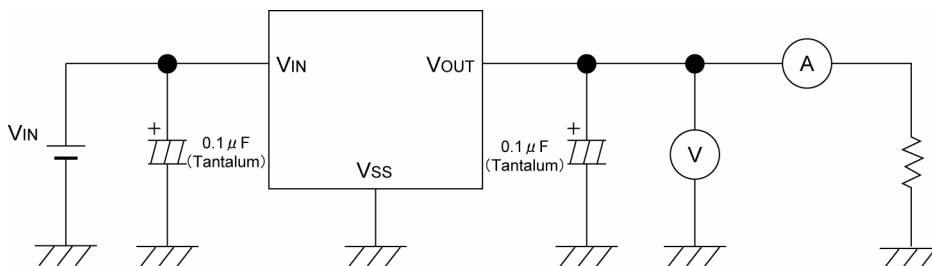

Circuit 2

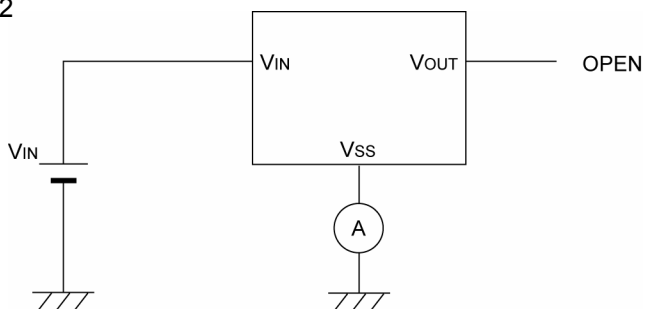

TYPICAL PERFORMANCE CHARACTERISTICS

(1) Output Voltage vs. Output Current

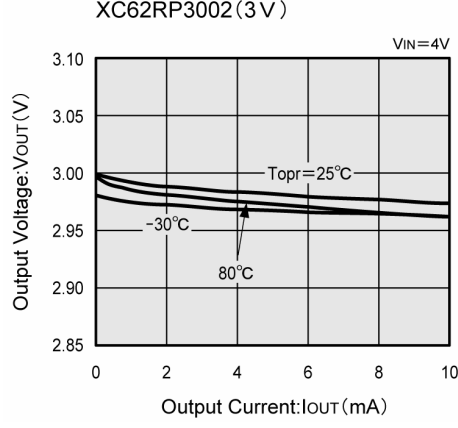
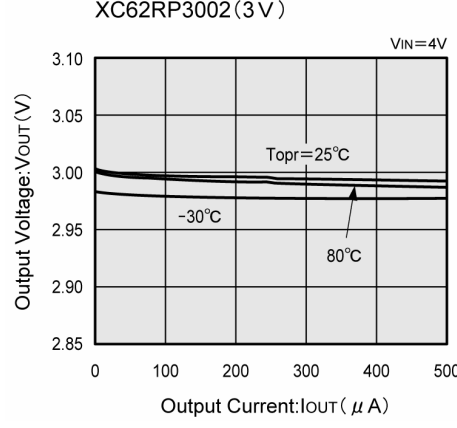
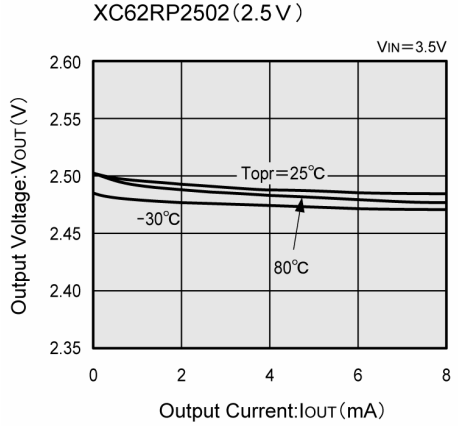
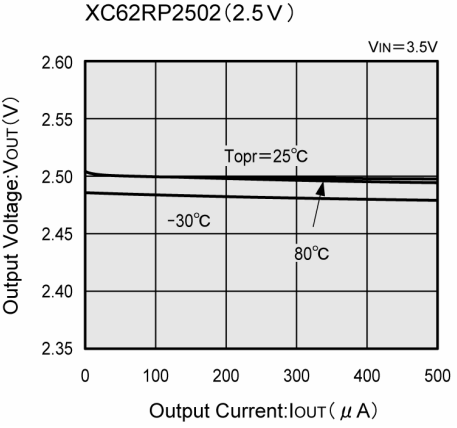
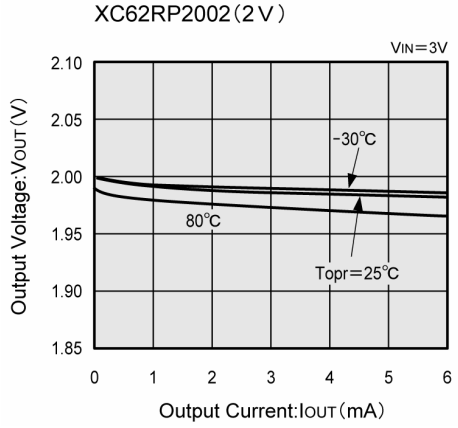
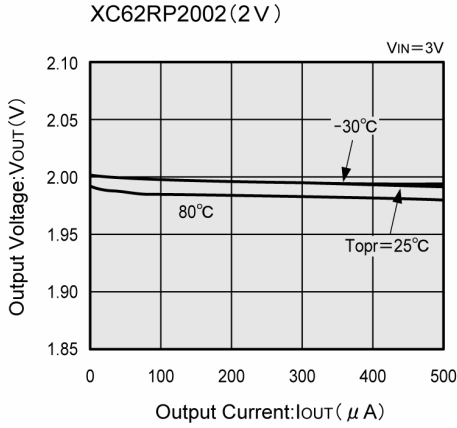
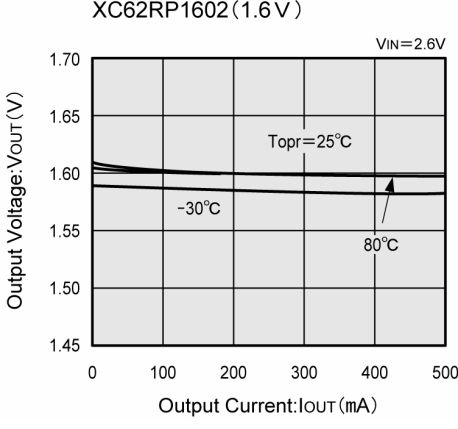
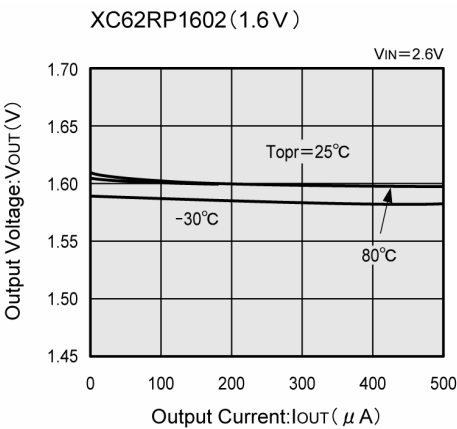

TYPICAL PERFORMANCE CHARACTERISTICS (Continued)

(2) Output Voltage vs. Input Voltage

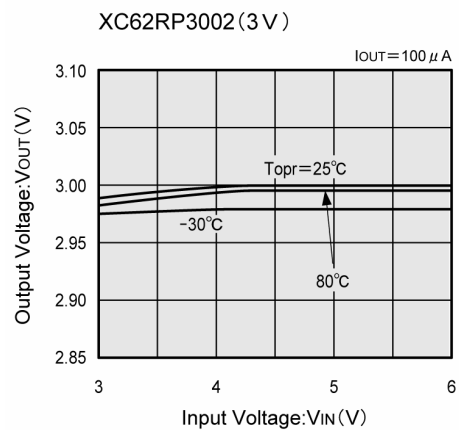
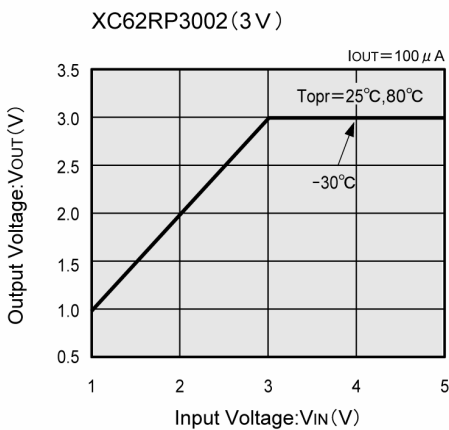
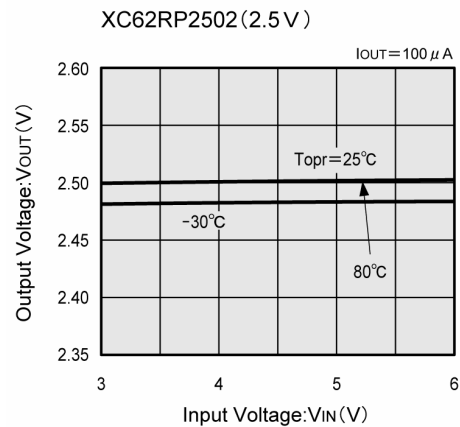
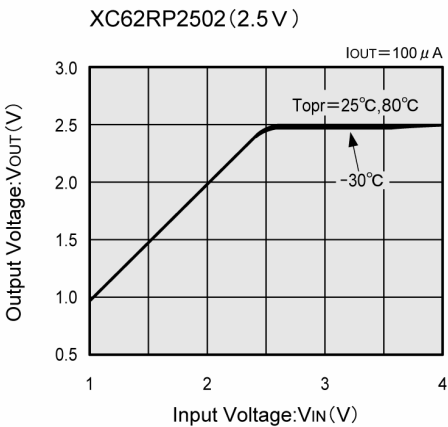
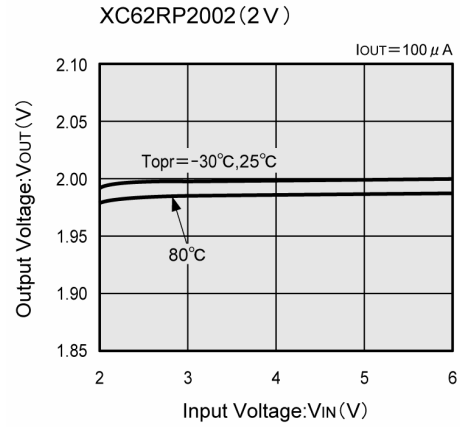
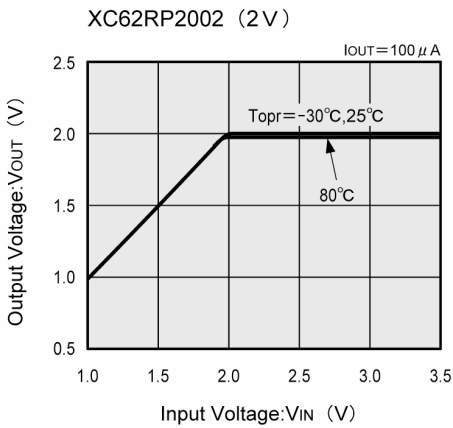
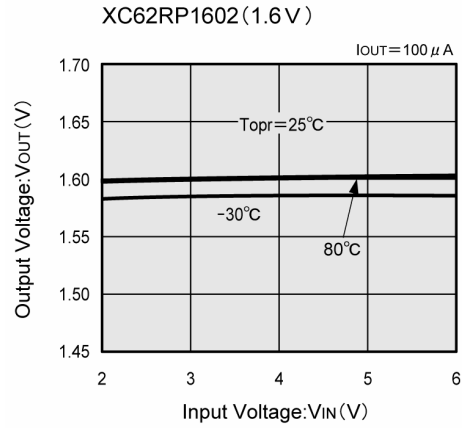
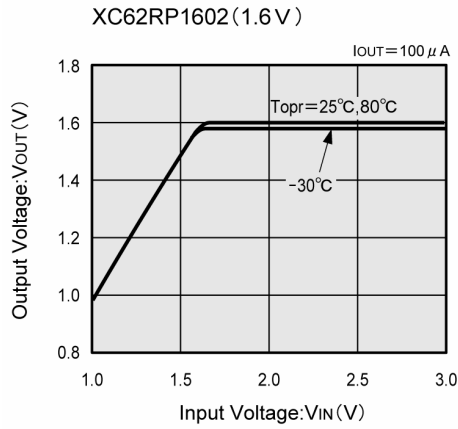

TYPICAL PERFORMANCE CHARACTERISTICS (Continued)

(3) Dropout Voltage vs. Output Current

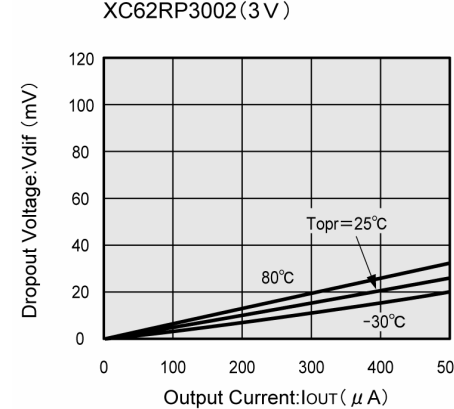
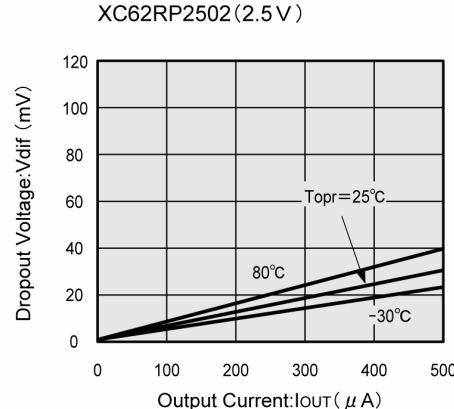
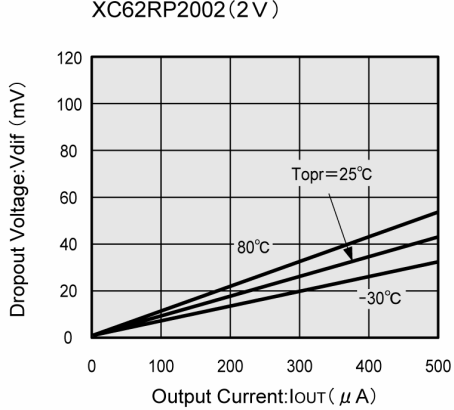
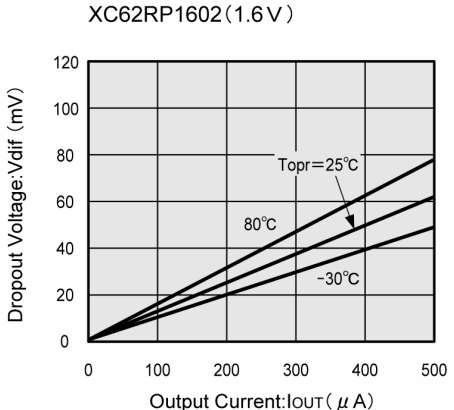

(4) Supply Current vs. Input Voltage

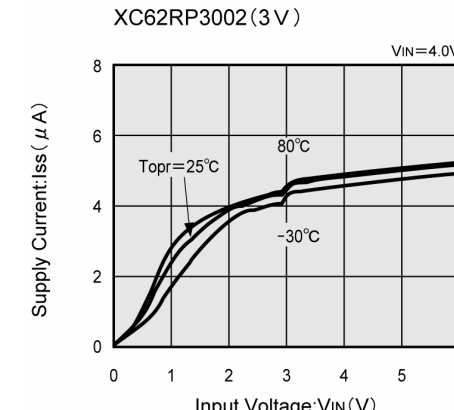
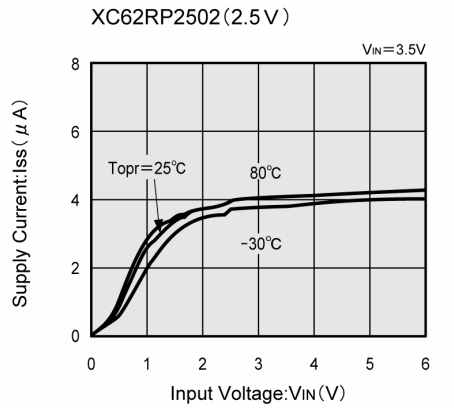
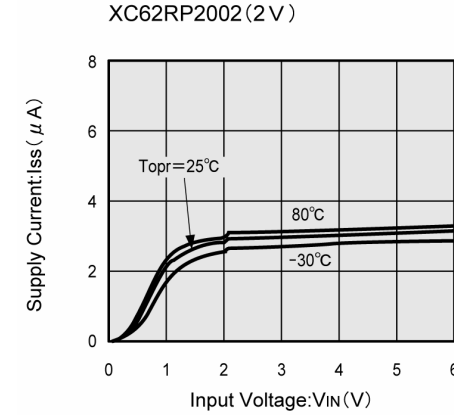
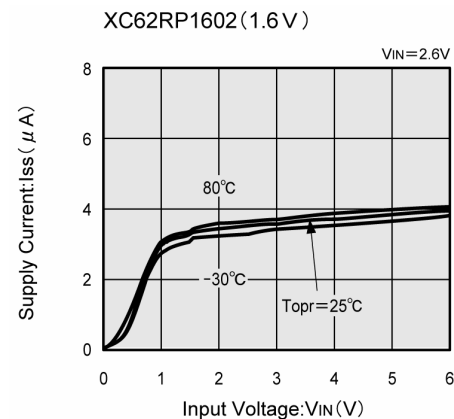

TYPICAL PERFORMANCE CHARACTERISTICS (Continued)

(5) Output Voltage vs. Ambient Temperature

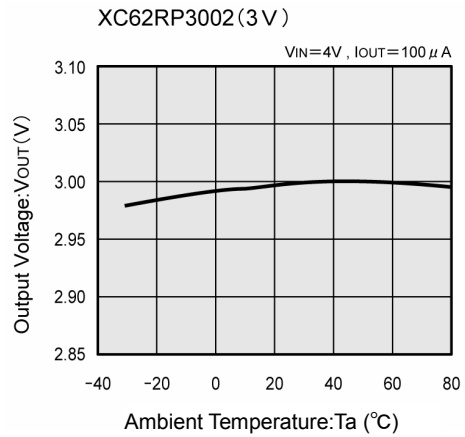
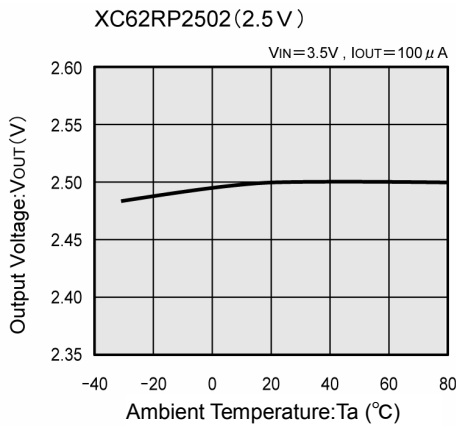
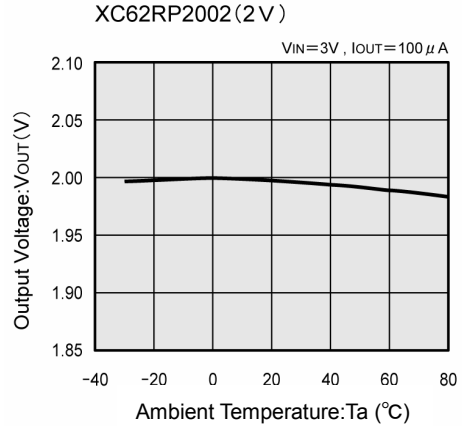
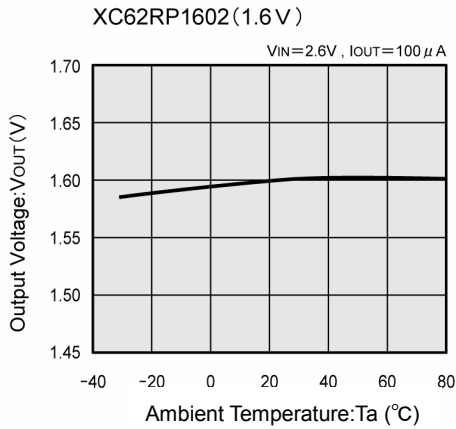

(6) Supply Current vs. Ambient Temperature

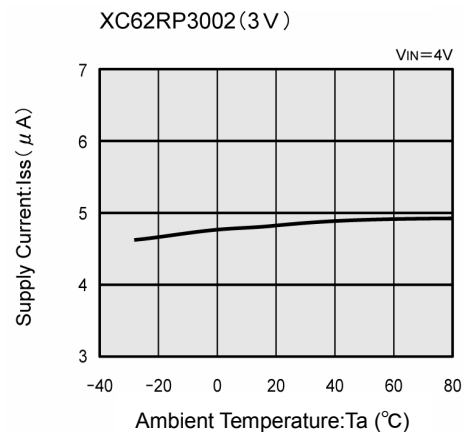
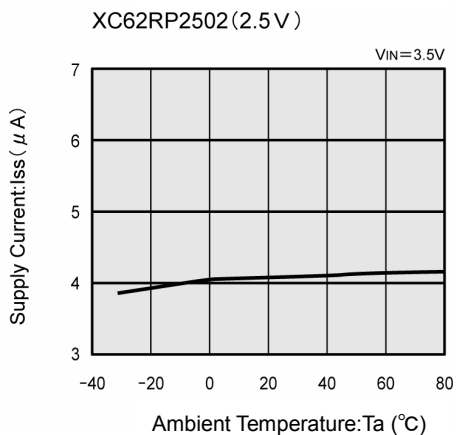
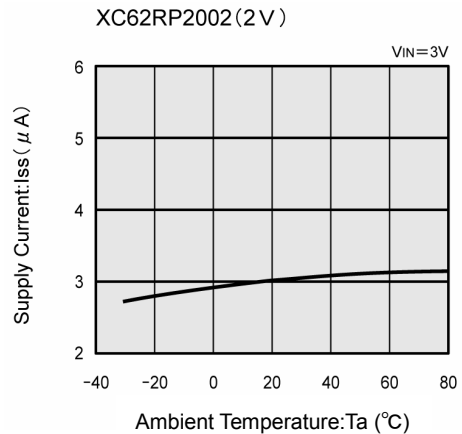
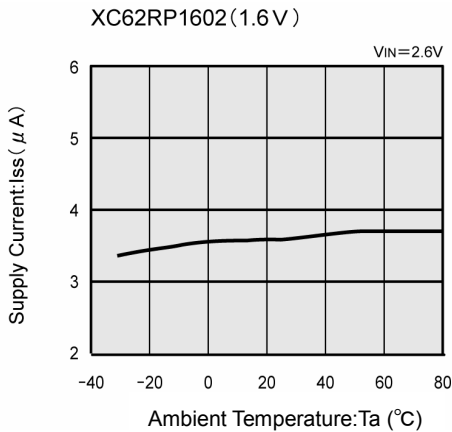

TYPICAL PERFORMANCE CHARACTERISTICS (Continued)

(7) Input Transient Response

XC62RP2002 (2V)

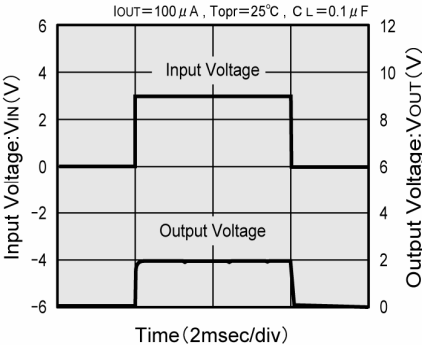

XC62RP2502 (2.5V)

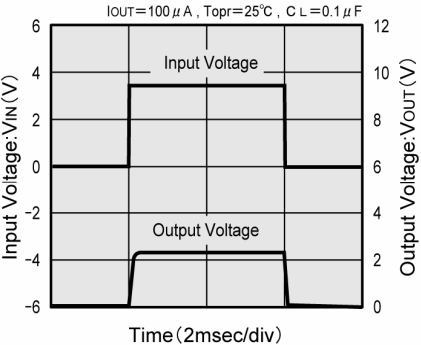

(8) Input Transient Response 2

XC62RP2002 (2V)

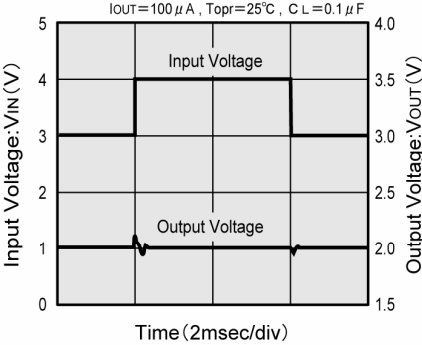

XC62RP2502 (2.5V)

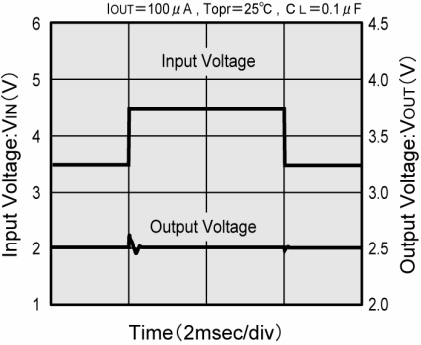

(9) Load Transient Response

XC62RP2002 (2V)

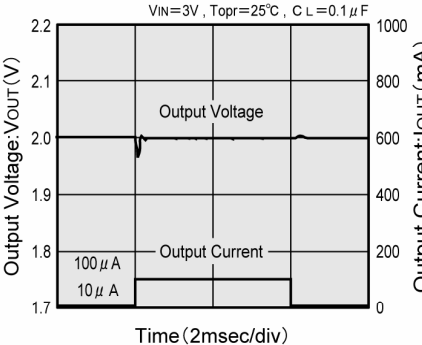

XC62RP2002 (2V)

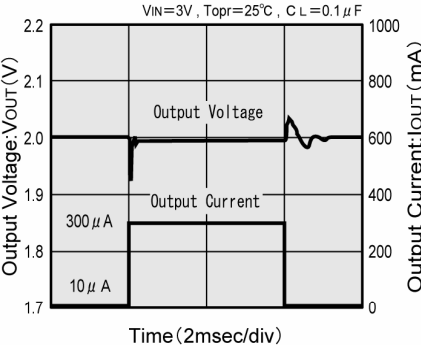

XC62RP2502 (2.5V)

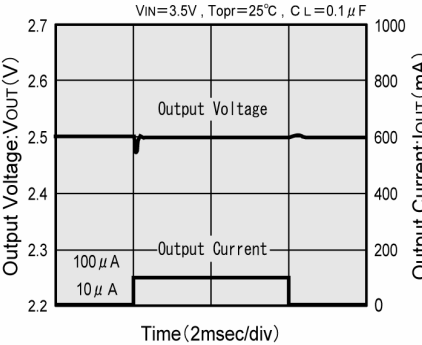

(10) Ripple Rejection Rate

XC62RP2502 (2.5V)

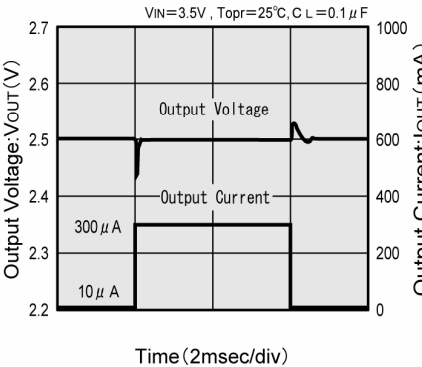

XC62RP2502 (2.5V)

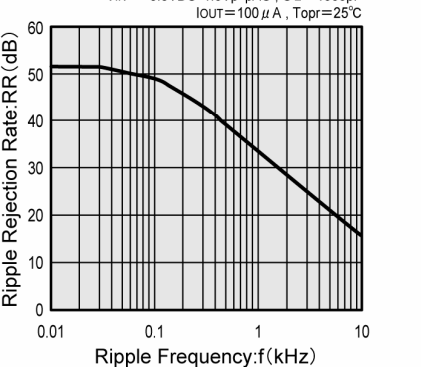

PACKAGING INFORMATION

● SOT-23

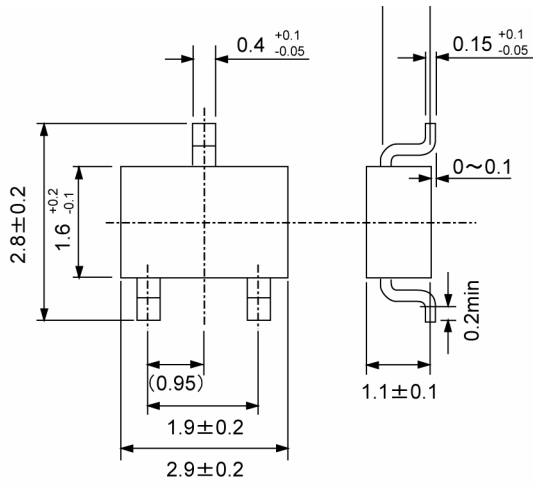

● SOT-89

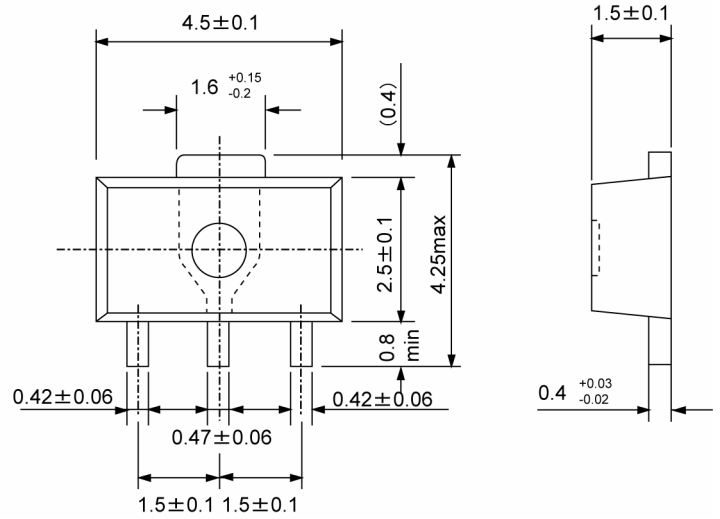

● TO-92

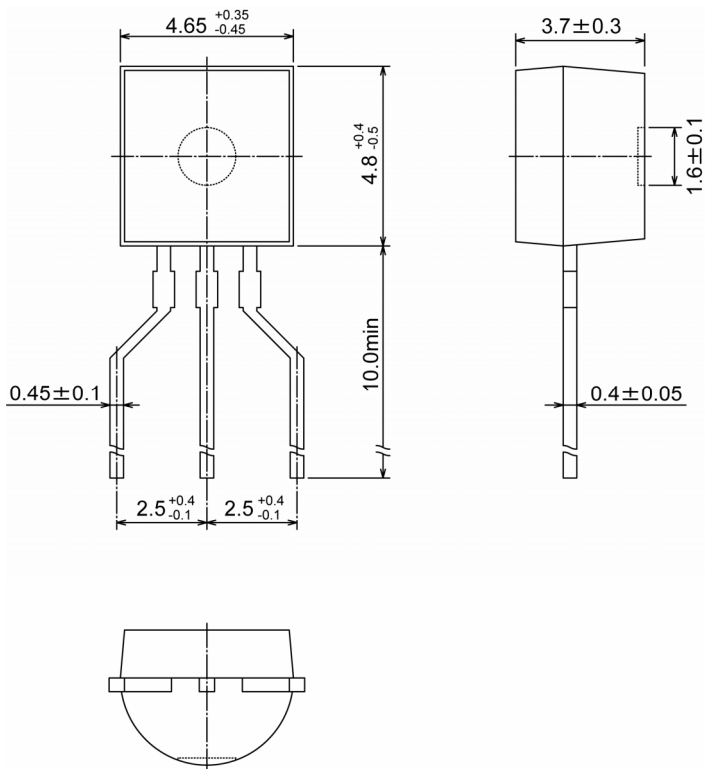

MARKING RULE

●SOT-23, SOT-89

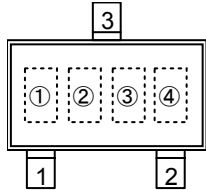

SOT-23
(TOP VIEW)

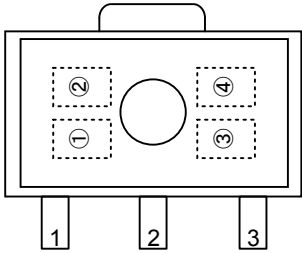

SOT-89
(TOP VIEW)

①Not used

②Represents integer of output voltage

MARK	VOLTAGE (V)
A	0.x
B	1.x
C	2.x
D	3.x

③Represents decimal number of output voltage

MARK	VOLTAGE (V)	MARK	VOLTAGE (V)
A	x.0	F	x.5
B	x.1	H	x.6
C	x.2	K	x.7
D	x.3	L	x.8
E	x.4	M	x.9

④Represents production lot number
0 to 9, A to Z repeated (G, I, J, O, Q, W excepted)

●TO-92

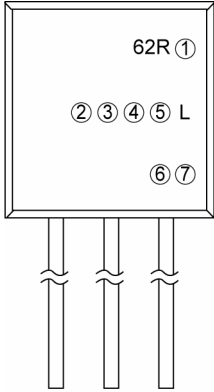

TO-92 (L Type)
(TOP VIEW)

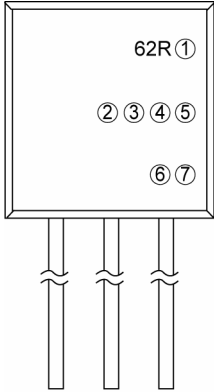

TO-92 (T Type)
(TOP VIEW)

①Represents polarity of output voltage

MARK	POLARITY
P	+ (Positive)

②③Represents output voltage

MARK		OUTPUT VOLTAGE (V)
②	③	
3	3	3.3
5	0	5.0

④Represents temperature characteristics

MARK	TEMPERATURE CHARACTERISTICS
0	±100 ppm (TYP.)

⑤Represents output voltage accuracy

MARK	OUTPUT VOLTAGE ACCURACY
1	Within ±1% (semi-custom)
2	Within ±2%

⑥Represents a least significant digit of production year

MARK	PRODUCTION YEAR
3	2003
4	2004

⑦Represents production lot number
0 to 9, A to Z repeated (G, I, J, O, Q, W excepted)

1. The products and product specifications contained herein are subject to change without notice to improve performance characteristics. Consult us, or our representatives before use, to confirm that the information in this catalog is up to date.
2. We assume no responsibility for any infringement of patents, patent rights, or other rights arising from the use of any information and circuitry in this catalog.
3. Please ensure suitable shipping controls (including fail-safe designs and aging protection) are in force for equipment employing products listed in this catalog.
4. The products in this catalog are not developed, designed, or approved for use with such equipment whose failure of malfunction can be reasonably expected to directly endanger the life of, or cause significant injury to, the user.
(e.g. Atomic energy; aerospace; transport; combustion and associated safety equipment thereof.)
5. Please use the products listed in this catalog within the specified ranges.
Should you wish to use the products under conditions exceeding the specifications, please consult us or our representatives.
6. We assume no responsibility for damage or loss due to abnormal use.
7. All rights reserved. No part of this catalog may be copied or reproduced without the prior permission of Torex Semiconductor Ltd.

TOREX SEMICONDUCTOR LTD.