

Power MOSFET

130 mAmps, 50 Volts

P-Channel SOT-323

These miniature surface mount MOSFETs reduce power loss conserve energy, making this device ideal for use in small power management circuitry. Typical applications are dc-dc converters, load switching, power management in portable and battery-powered products such as computers, printers, cellular and cordless telephones.

- Energy Efficient
- Miniature SOT-323 Surface Mount Package Saves Board Space
- Pb-Free Package is available.

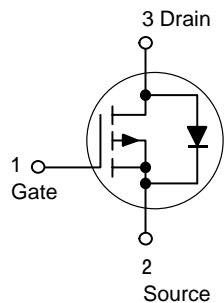

THERMAL CHARACTERISTICS

Characteristic	Symbol	Max	Unit
Total Device Dissipation FR-5 Board (Note 3.) $T_A = 25^\circ\text{C}$ Derate above 25°C	P_D	225 1.8	mW mW/ $^\circ\text{C}$
Thermal Resistance, Junction to Ambient	$R_{\theta JA}$	556	$^\circ\text{C}/\text{W}$
Total Device Dissipation Alumina Substrate, (Note 4.) $T_A = 25^\circ\text{C}$ Derate above 25°C	P_D	300 2.4	mW mW/ $^\circ\text{C}$
Thermal Resistance, Junction to Ambient	$R_{\theta JA}$	417	$^\circ\text{C}/\text{W}$
Junction and Storage Temperature	T_J, T_{stg}	-55 to +150	$^\circ\text{C}$

MAXIMUM RATINGS ($T_J = 25^\circ\text{C}$ unless otherwise noted)

Rating	Symbol	Value	Unit
Drain-to-Source Voltage	V_{DSS}	50	V_{dc}
Gate-to-Source Voltage – Continuous	V_{GS}	± 20	V_{dc}
Drain Current			mA
– Continuous @ $T_A = 25^\circ\text{C}$	I_D	130	
– Pulsed Drain Current ($t_p \leq 10 \mu\text{s}$)	I_{DM}	520	
Total Power Dissipation @ $T_A = 25^\circ\text{C}$	P_D	225	mW
Operating and Storage Temperature Range	T_J, T_{stg}	- 55 to 150	$^\circ\text{C}$
Thermal Resistance – Junction-to-Ambient	$R_{\theta JA}$	556	$^\circ\text{C}/\text{W}$
Maximum Lead Temperature for Soldering Purposes, for 10 seconds	T_L	260	$^\circ\text{C}$

LBSS84WT1G

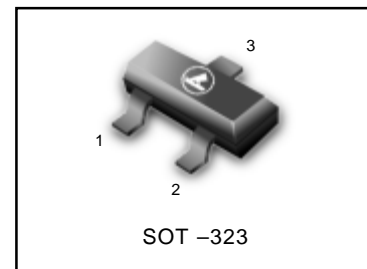

Marking Diagram

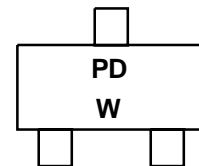

W = Work Week

ORDERING INFORMATION

Device	Package	Shipping
LBSS84WT1G	SOT-323	3000/Tape&Reel
LBSS84WT1G	SOT-323	10000/Tape&Reel

LBSS84WT1G

ELECTRICAL CHARACTERISTICS ($T_A = 25^\circ\text{C}$ unless otherwise noted)

Characteristic	Symbol	Min	Typ	Max	Unit
----------------	--------	-----	-----	-----	------

OFF CHARACTERISTICS

Drain-to-Source Breakdown Voltage ($V_{GS} = 0\text{ Vdc}$, $I_D = 250\ \mu\text{Adc}$)	$V_{(BR)DSS}$	50	–	–	Vdc
Zero Gate Voltage Drain Current ($V_{DS} = 25\text{ Vdc}$, $V_{GS} = 0\text{ Vdc}$) ($V_{DS} = 50\text{ Vdc}$, $V_{GS} = 0\text{ Vdc}$) ($V_{DS} = 50\text{ Vdc}$, $V_{GS} = 0\text{ Vdc}$, $T_J = 125^\circ\text{C}$)	I_{DSS}	–	–	0.1 15 60	μAdc
Gate-Body Leakage Current ($V_{GS} = \pm 20\text{ Vdc}$, $V_{DS} = 0\text{ Vdc}$)	I_{GSS}	–	–	± 60	μAdc

ON CHARACTERISTICS (Note 1.)

Gate-Source Threshold Voltage ($V_{DS} = V_{GS}$, $I_D = 1.0\text{ mAdc}$)	$V_{GS(th)}$	0.8	–	2.0	Vdc
Static Drain-to-Source On-Resistance ($V_{GS} = 5.0\text{ Vdc}$, $I_D = 100\text{ mAdc}$)	$r_{DS(on)}$	–	5.0	10	Ohms
Transfer Admittance ($V_{DS} = 25\text{ Vdc}$, $I_D = 100\text{ mAdc}$, $f = 1.0\text{ kHz}$)	$ y_{fs} $	50	–	–	mS

DYNAMIC CHARACTERISTICS

Input Capacitance	($V_{DS} = 5.0\text{ Vdc}$)	C_{iss}	–	30	–	pF
Output Capacitance	($V_{DS} = 5.0\text{ Vdc}$)	C_{oss}	–	10	–	
Transfer Capacitance	($V_{DG} = 5.0\text{ Vdc}$)	C_{rss}	–	5.0	–	

SWITCHING CHARACTERISTICS (Note 2.)

Turn-On Delay Time	(VDD = -15 Vdc, $I_D = -2.5\text{ Adc}$, $R_L = 50\ \Omega$)	$t_{d(on)}$	–	2.5	–	ns
Rise Time		t_r	–	1.0	–	
Turn-Off Delay Time		$t_{d(off)}$	–	16	–	
Fall Time		t_f	–	8.0	–	
Gate Charge		Q_T	–	6000	–	pC

SOURCE-DRAIN DIODE CHARACTERISTICS

Continuous Current	I_S	–	–	0.130	A
Pulsed Current	I_{SM}	–	–	0.520	
Forward Voltage (Note 2.)	V_{SD}	–	2.5	–	V

1. Pulse Test: Pulse Width $\leq 300\ \mu\text{s}$, Duty Cycle $\leq 2\%$.
2. Switching characteristics are independent of operating junction temperature.

TYPICAL ELECTRICAL CHARACTERISTICS

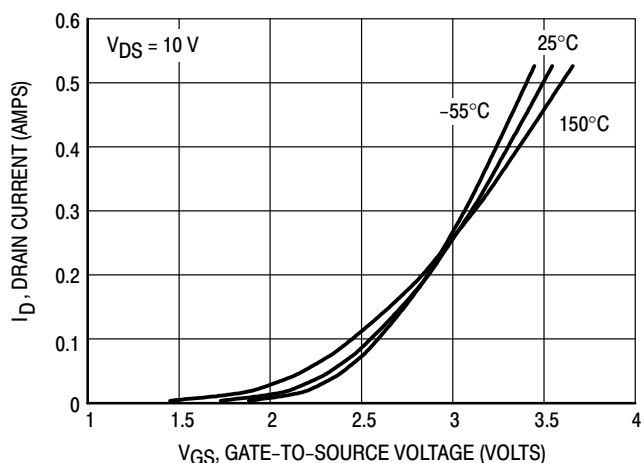

Figure 1. Transfer Characteristics

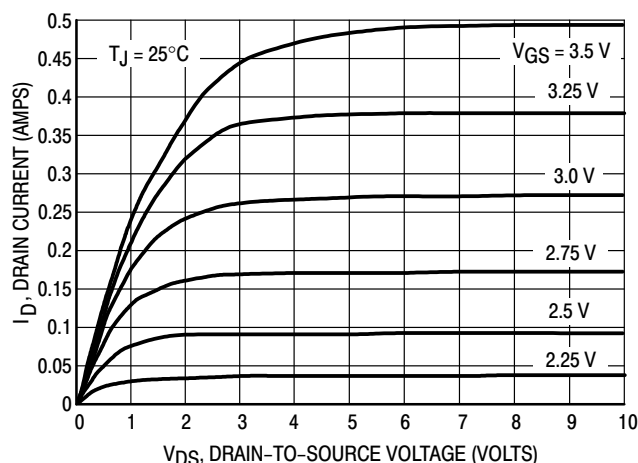

Figure 2. On-Region Characteristics

LBSS84WT1G

TYPICAL ELECTRICAL CHARACTERISTICS

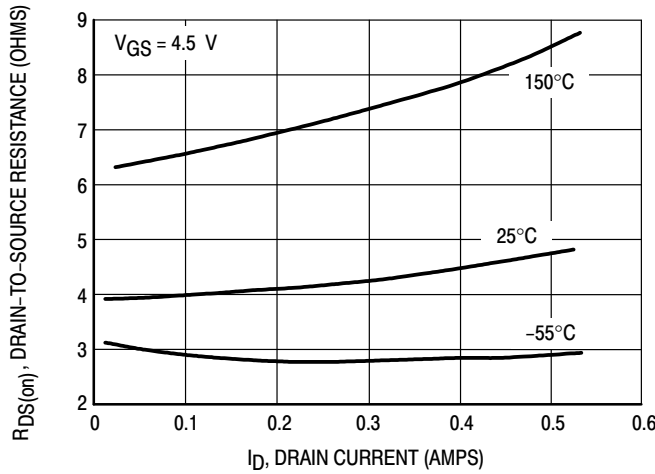

Figure 3. On-Resistance versus Drain Current

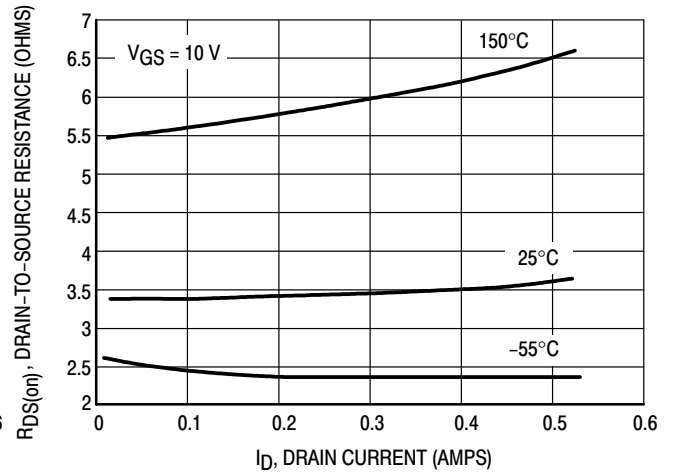

Figure 4. On-Resistance versus Drain Current

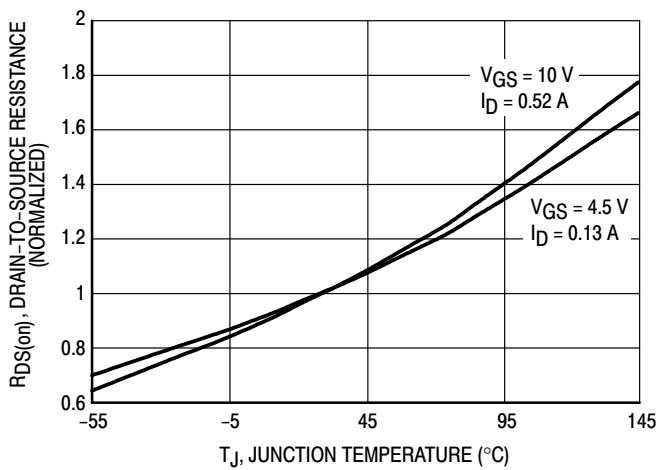

Figure 5. On-Resistance Variation with Temperature

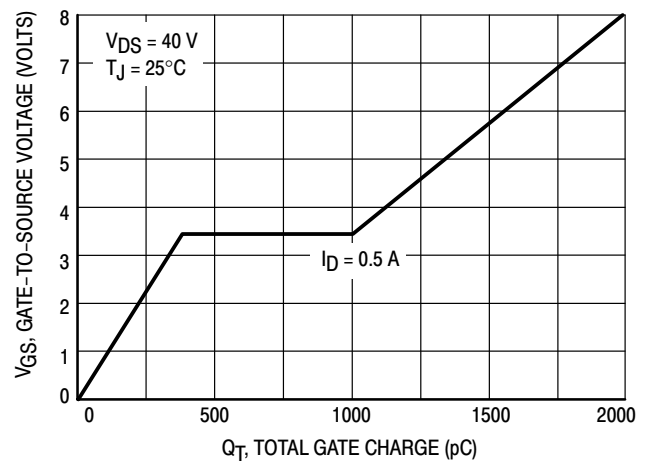

Figure 6. Gate Charge

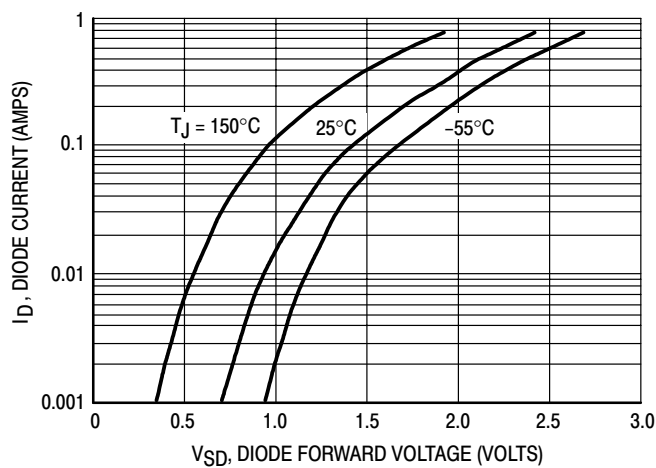
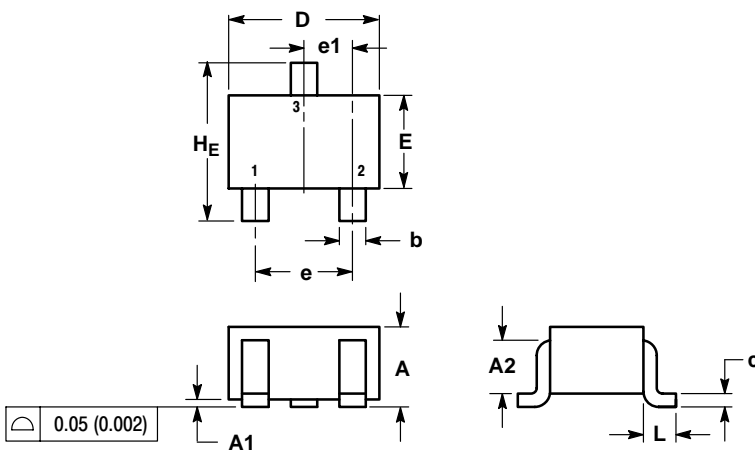

Figure 7. Body Diode Forward Voltage

LBSS84WT1G

SC-70 (SOT-323)



NOTES:
 1. DIMENSIONING AND TOLERANCING PER ANSI Y14.5M, 1982.
 2. CONTROLLING DIMENSION: INCH.

DIM	MILLIMETERS			INCHES		
	MIN	NOM	MAX	MIN	NOM	MAX
A	0.80	0.90	1.00	0.032	0.035	0.040
A1	0.00	0.05	0.10	0.000	0.002	0.004
A2	0.7 REF			0.028 REF		
b	0.30	0.35	0.40	0.012	0.014	0.016
c	0.10	0.18	0.25	0.004	0.007	0.010
D	1.80	2.10	2.20	0.071	0.083	0.087
E	1.15	1.24	1.35	0.045	0.049	0.053
e	1.20	1.30	1.40	0.047	0.051	0.055
e1	0.65 BSC			0.026 BSC		
L	0.425 REF			0.017 REF		
HE	2.00	2.10	2.40	0.079	0.083	0.095

GENERIC MARKING DIAGRAM

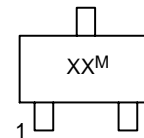

- XX = Specific Device Code
- M = Date Code
- = Pb-Free Package

*This information is generic. Please refer to device data sheet for actual part marking. Pb-Free indicator, "G" or microdot "▪", may or may not be present.

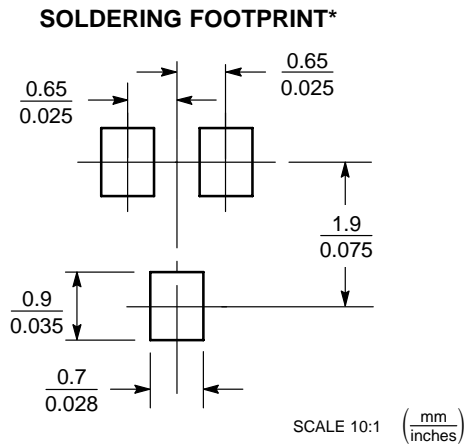

EMBOSSED TAPE AND REEL DATA FOR DISCRETES

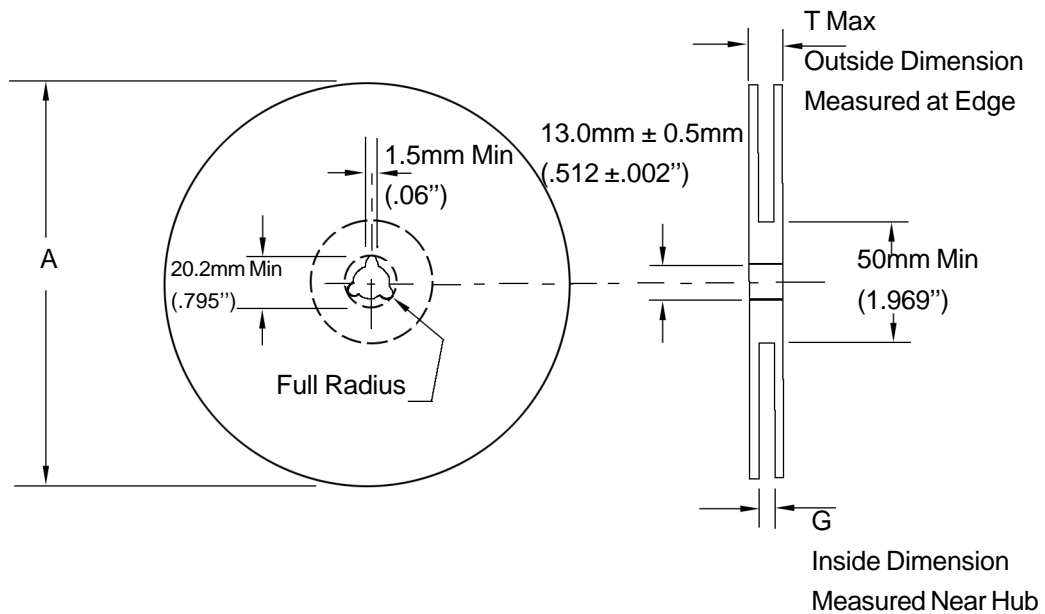

Size	A Max	G	T Max
8 mm	330mm (12.992")	8.4mm+1.5mm, -0.0 (.33"+.059", -0.00)	14.4mm (.56")
12mm	330mm (12.992")	12.4mm+2.0mm, -0.0 (.49 "+ .079", -0.00)	18.4mm (.72")
16mm	360mm (14.173")	16.4mm+2.0mm, -0.0 (.646"+.078", -0.00)	22.4mm (.882")
24 mm	360mm (14.173")	24.4mm+2.0mm, -0.0 (.961"+.070", -0.00)	30.4mm (1.197")

Reel Dimensions

Metric Dimensions Govern — English are in parentheses for reference only

Storage Conditions

Temperature: 5 to 40 Deg.C (20 to 30 Deg. C is preferred)

Humidity: 30 to 80 RH (40 to 60 is preferred)

Recommended Period: One year after manufacturing

(This recommended period is for the soldering condition only. The characteristics and reliabilities of the products are not restricted to this limitation)

Shipment Specification

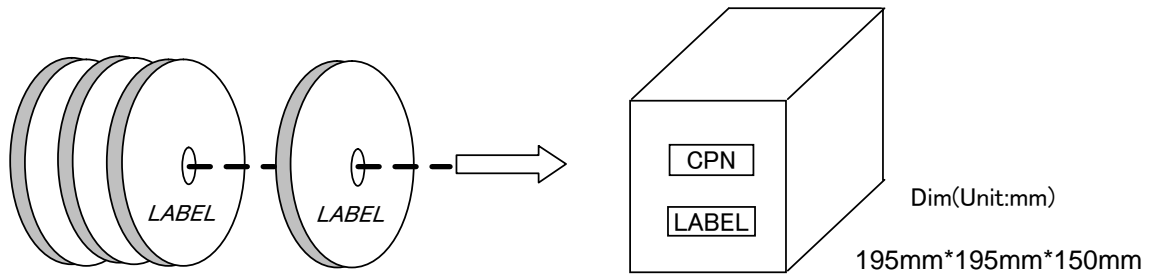

10 Reel

3000PCS/Reel
8000PCS/Reel (SOT-723,SOD-723)

10Reel/Inner Box
30KPCS/Inner Box
80KPCS/Inner Box (SOT-723,SOD-723)

Dim(Unit:mm)
460mm*400mm*420mm

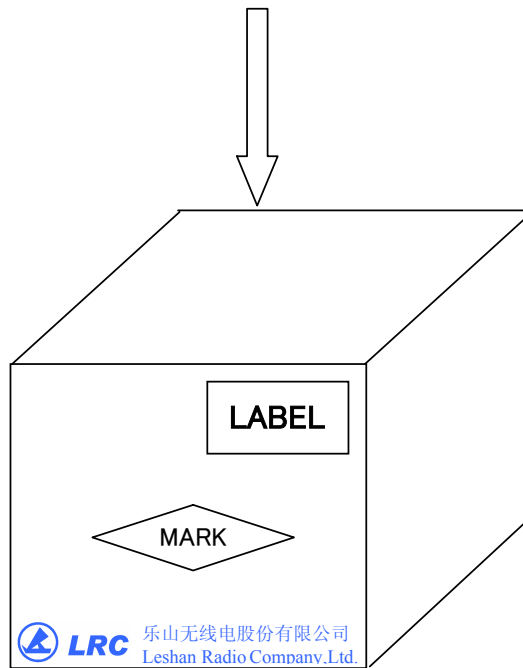

12 Inner Box/Carton

360KPCS/Carton
960KPCS/Carton (SOT-723,SOD-723)