

# CATV Ultra-Linear Power Amp

# TGA2801D-SG



## Key Features

- Ultra-Low Distortion (52dBm IP3 typ.)
- High Power Compression (P1dB 31.5 dBm typ.)
- Flat Gain
- Wide Bandwidth (40MHz - 1GHz)
- Low DC Power Consumption
- Single Supply Bias (+12V)
- Proven GaAs Technology

## Description

The TriQuint TGA2801D-SG is an ultra-linear, packaged power amplifier which operates from 40MHz to 1000MHz. The amplifier is packaged in a standard 16 lead SOIC package. The amplifier provides a flat gain along with ultra-low distortion. It also provides a high output power with a low DC power consumption. This amplifier is ideally suited for use in CATV distribution systems or other applications requiring high output powers and extremely low distortion.

Evaluation Boards are available upon request.  
RoHS & Lead-Free compliant

## Primary Applications

- HFC Nodes
- CATV Line Amplifiers
- Head End Equipment

Gain in a Typical Circuit  
w/External Balun Effects Removed

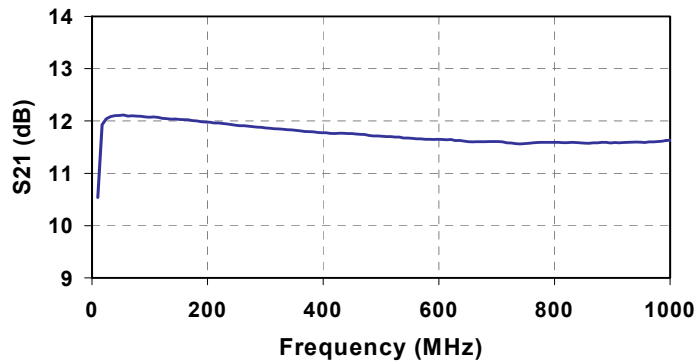

TGA2801D Compression

Flat to 870 MHz: 110 Ch, no QAM, 550mA

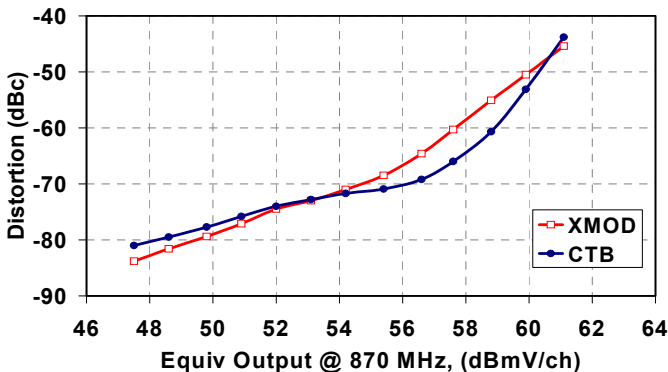

TGA2801D Compression

13.5 dB Tilt to 870 MHz: 79 Ch, QAM to 870 MHz with 6 dB offset, 550mA

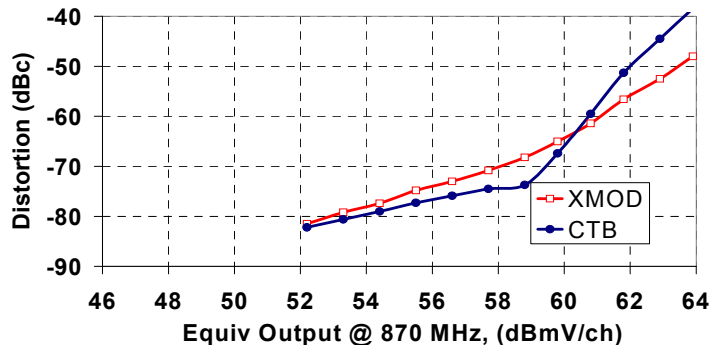

**Maximum Ratings 1/**

Symbol	Parameter	Min	Max	Units	Notes
V <sub>DD</sub>	Bias Supply Voltage	0	15	V	
I <sub>DD</sub>	Bias Supply Current		615	mA	
P <sub>IN</sub>	RF Input Power		70	dBmV	
T <sub>ASSY</sub>	Assembly Temperature (30 seconds max)		260	°C	
T <sub>STG</sub>	Storage Temperature	-65	150	°C	
T <sub>CASE</sub>	Package Operating Temperature (Heat Slug)	-40	120	°C	

1/ These values reflect maximum operable values for this device. Operating above the recommended values may directly affect median lifetime, T<sub>M</sub>.

**DC Specifications**

Symbol	Parameter	Typ	Unit
V <sub>DD</sub>	Bias Supply Voltage	12	V
I <sub>DD</sub>	Bias Supply Current	540	mA
V <sub>G1</sub>	Gate 1 Voltage (Pin 7)	0.68	V
V <sub>G2</sub>	Gate 2 Voltage (Pin 2)	4.15	V
V <sub>out1</sub>	RF Output 1 Voltage (Pin 14)	V <sub>DD</sub>	V
V <sub>out2</sub>	RF Output 2 Voltage (Pin 11)	V <sub>DD</sub>	V

**Thermal Information**

Parameter	Test Conditions	T <sub>CH</sub> (°C)	θ <sub>JC</sub> (°C/W)	T <sub>M</sub> (hrs)
θ <sub>JC</sub> Thermal Resistance (Channel to Backside of Package)	V <sub>DD</sub> = 12V I <sub>DD</sub> = 540mA P <sub>DISS</sub> = 6.48W T <sub>BASE</sub> = 85°C	139	8.3	5E8

**RF Specifications**

$T_A=25^{\circ}\text{C}$ ,  $V_{DD}=12\text{V}$

Symbol	Parameter	Min	Typ	Max	Units
BW	Bandwidth	40		1000	MHz
$S_{21}$	Gain <u>1/</u>	10	12		dB
GF	Gain Flatness <u>1/</u>		$\pm 0.3$		dB
NF	Noise Figure		2.75		dB
$P_{1dB}$	1dB Gain Compression	29	31.5		dBm
$IP_3$	Two-Tone, Third-Order Intercept (750MHz)	44	52		dBm
CTB	Composite Triple Beat Distortion <u>2/</u>		-80		dBc
CSO	Composite Second Order Distortion <u>2/</u>		-72		dBc
XMOD	Cross Modulation <u>2/</u>		-73		dBc
IRL	Input Return Loss <u>1/ 3/</u>		22		dB
ORL	Output Return Loss <u>1/ 3/</u>		22		dB
$I_D$	Drain Current <u>4/</u>		540	600	mA

1/ Measured performance of chip alone. Balun effects have been removed.

2/ 112-Channel flat, +44dBmV/channel output

3/ Using application circuit on last page

4/ Increasing drain current will improve linearity of device

**Typical Measured S-Parameters  
Using Application Circuit**  
(includes effects of external baluns)

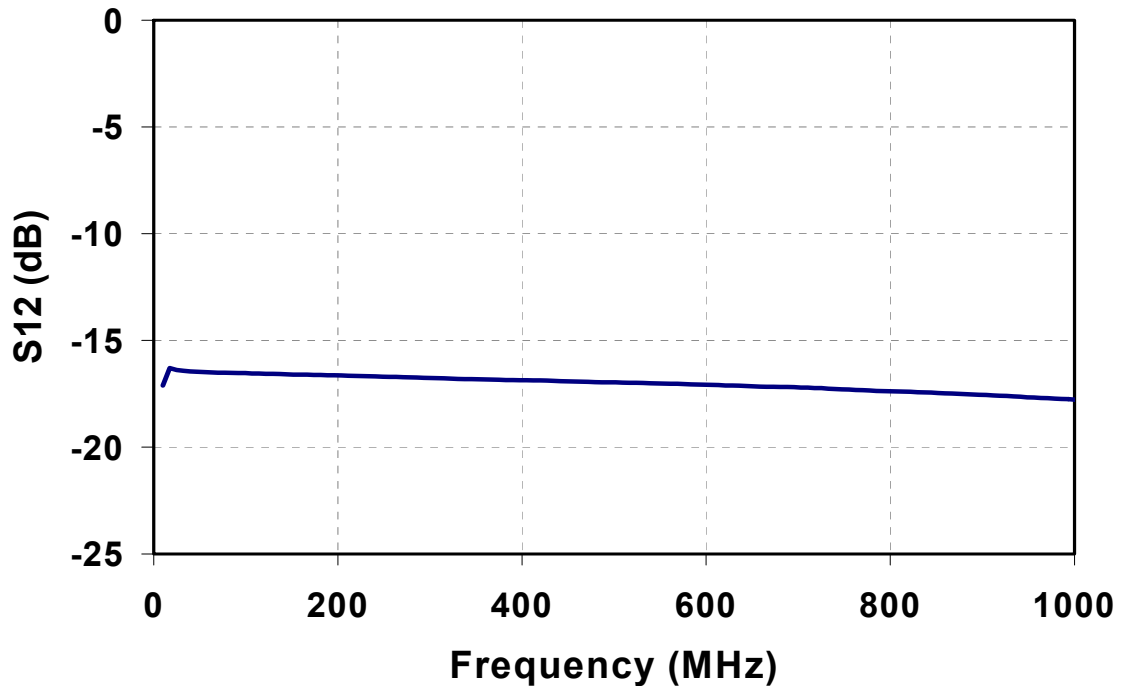
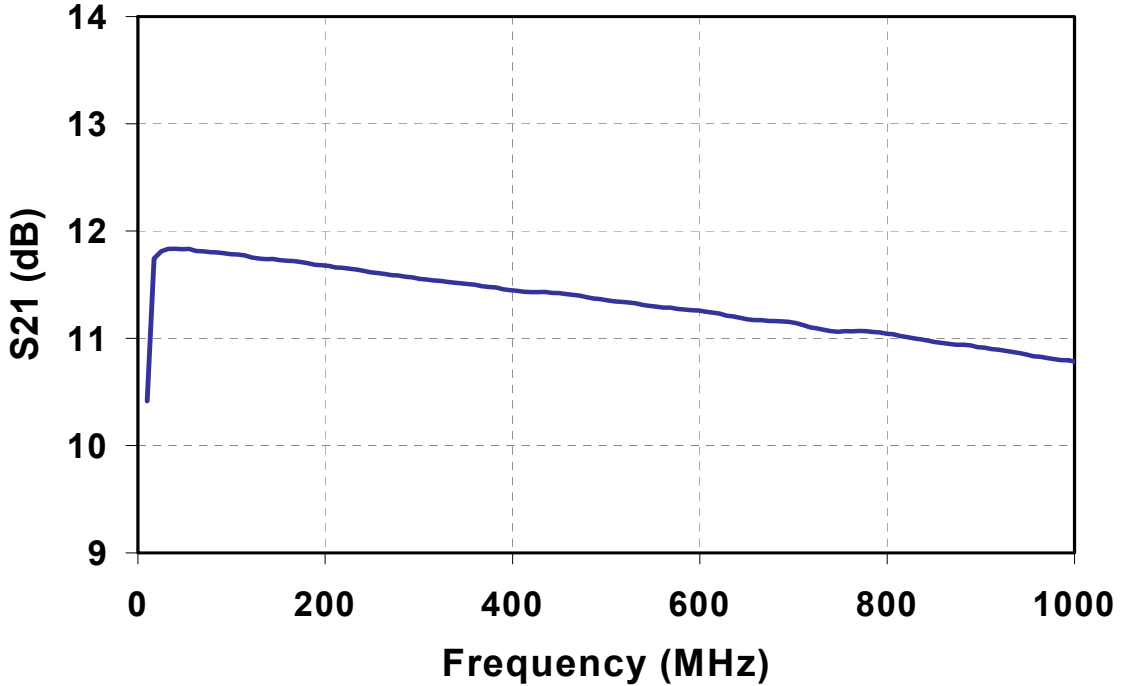

**Typical Measured S-Parameters  
Using Application Circuit**  
(includes effects of external baluns)

**TGA2801D-SG**

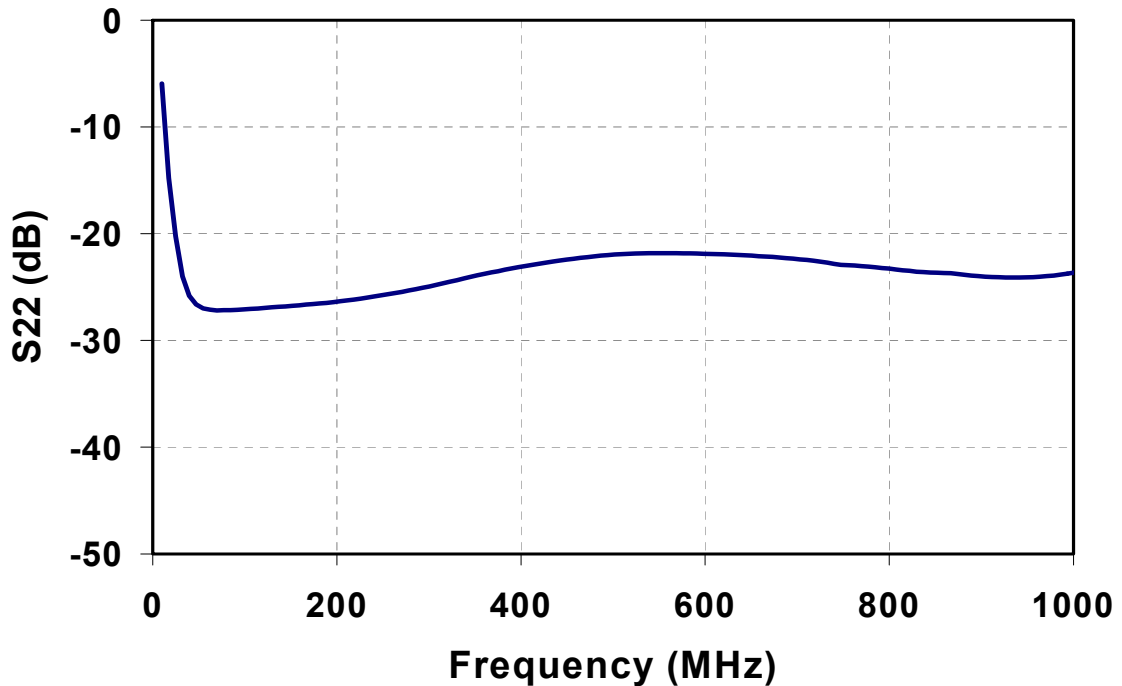
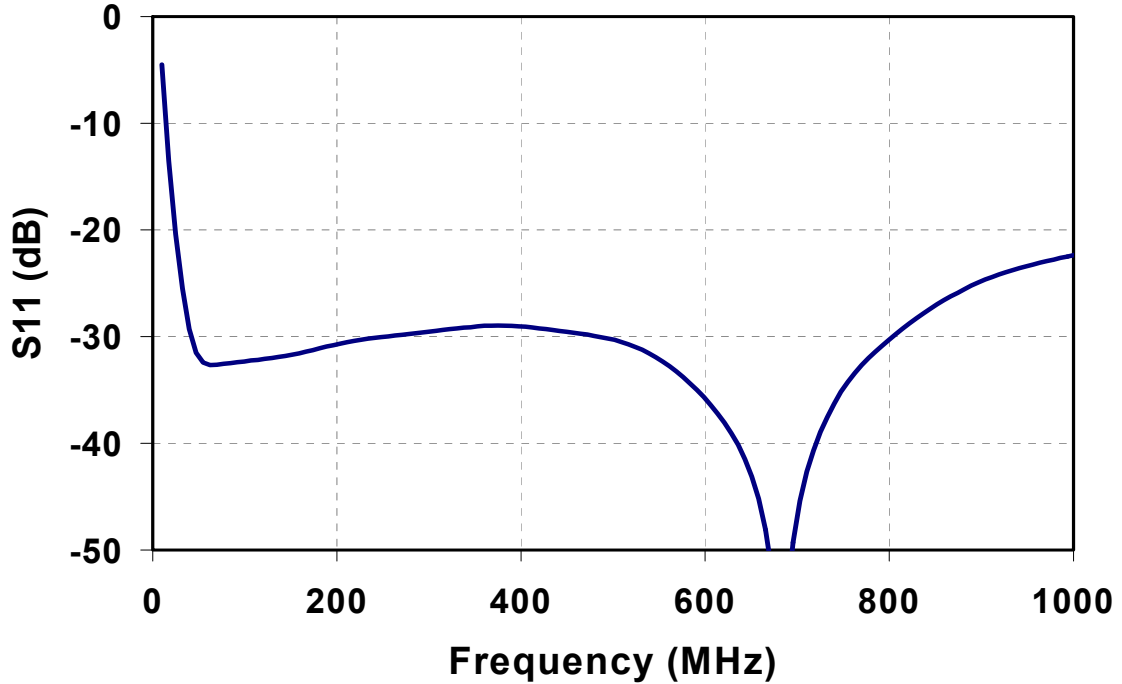

**Typical Measured Performance  
Using Application Circuit**  
(includes effects of external baluns)

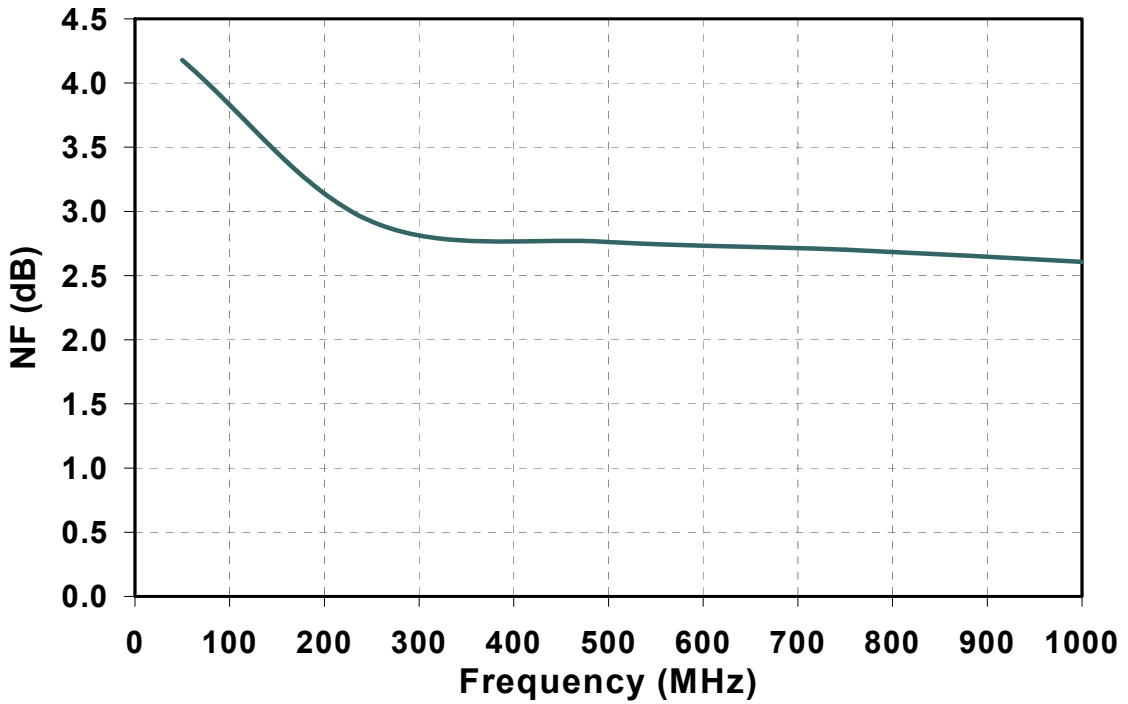

**Mechanical Specifications**

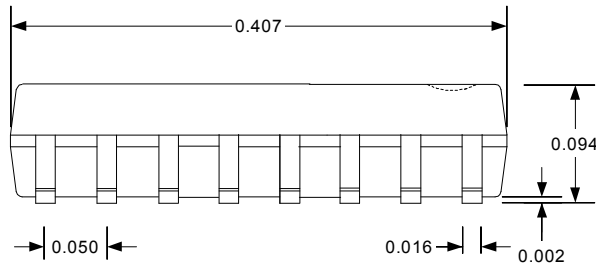
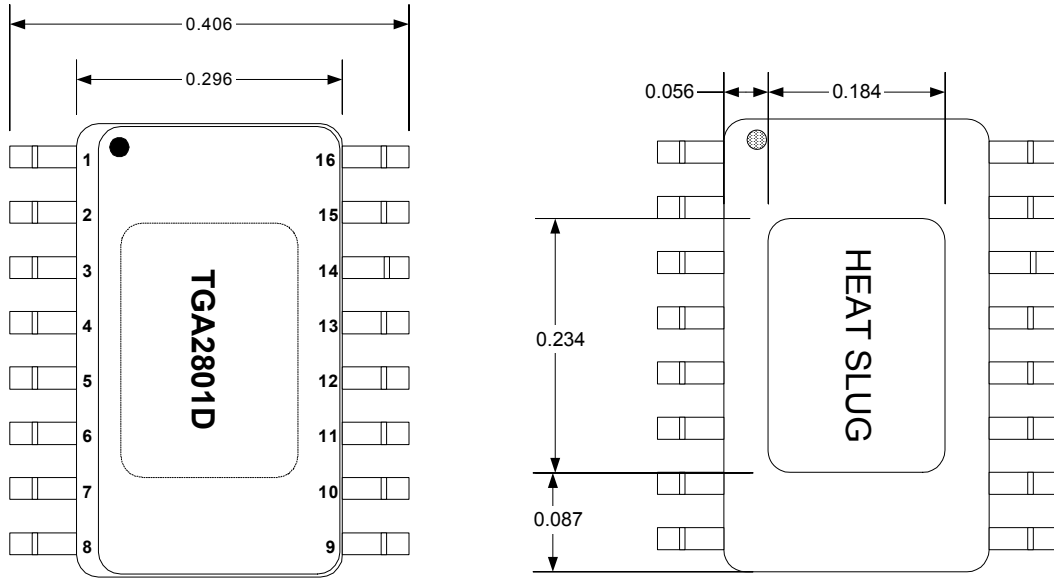

**Bottom View**

**Pinout**

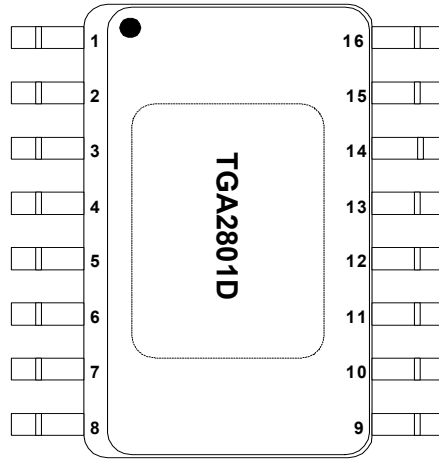

**Pin Description**

Pin	Description
1	GND
2	Gate 2: Open Circuit on PC Board
3	RF Input 1
4	GND
5	GND
6	RF Input 2
7	Gate 1: Current Adjust $R_1 = \text{open circuit}$
8	GND
9	GND
10	$V_{DD}$
11	RF Output 2
12	GND
13	GND
14	RF Output 1
15	$V_{DD}$
16	GND



Recommended Assembly

TGA2801D-SG

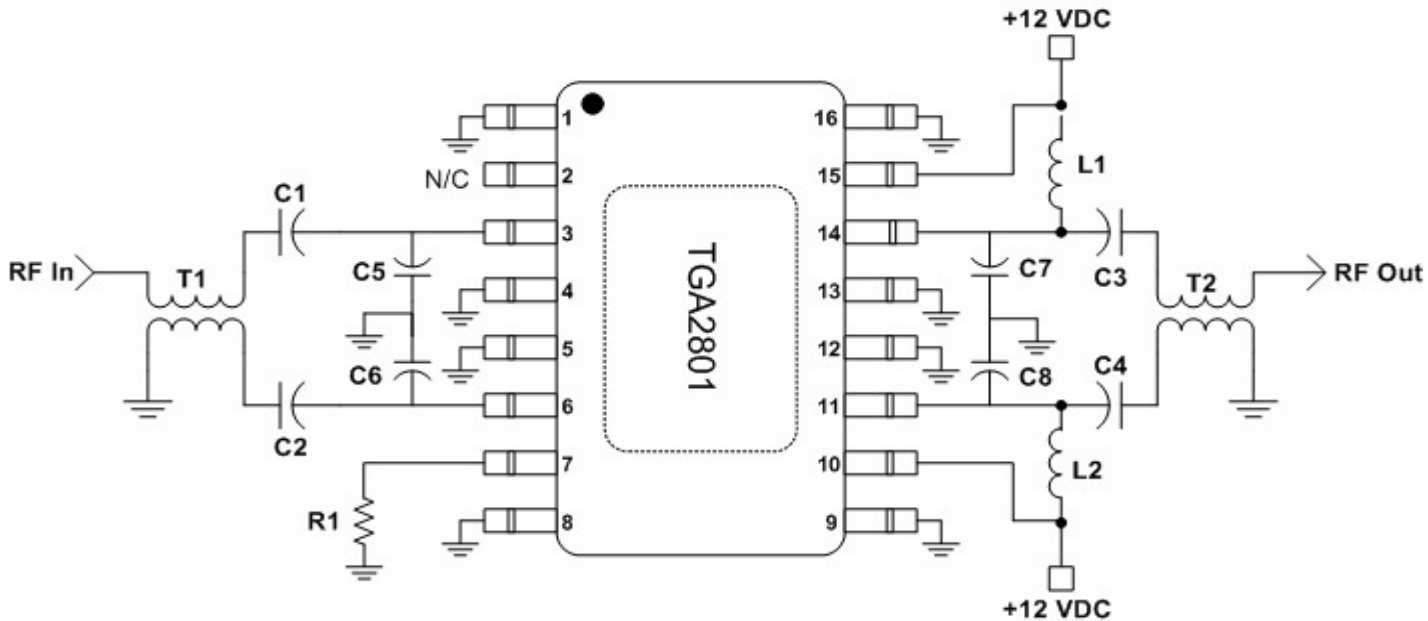

Ref	Description
C1	0.01 $\mu$ F Capacitor
C2	0.01 $\mu$ F Capacitor
C3	300pF Capacitor
C4	300pF Capacitor
C5 - C8	1.0pF - 2.0pF Capacitor <u>3/</u>
L1	390nH Inductor
L2	390nH Inductor
R1	Current Adjust <u>2/</u> R <sub>1</sub> = open circuit
T1	Balun <u>1/</u>
T2	Balun <u>1/</u>

1/ Balun performance impacts amplifier return losses and gain. Best performance can be achieved by winding 34 or 36 gauge bifilar wire around a small binocular core made from low-loss magnetic material. Suitable wire may be obtained from MWS Wire Industries. Core vendors include Ferronics, Fairrite, TDK, and Micrometals.

Alternatively, off-the-shelf baluns can be purchased from a number of vendors including Mini-Circuits (**ADTL1-10-75-1, used for this data**), ADTL1-18-75), M/A-COM (ETC1-1-13), and Pulse Engineering (CX2071).

2/ Current can be adjusted by either changing resistor, R1, or forcing a voltage on pin 7.

3/ Tunes out balun inductance. Selected for best return loss.