

Description

The 1812L series device provides surface mount overcurrent protection for applications where resettable protection is desired.

Features

- RoHS compliant and lead-free
- Fast response to fault currents
- Compact design saves board space
- Low resistance
- Low-profile
- Compatible with high temperature solders

Applications

- Plug and play protection for motherboards and peripherals
- USB peripherals
- PCI cards
- Game console port protection



Agency Approvals

AGENCY	AGENCY FILE NUMBER
	E183209
	R50082521

Electrical Characteristics

Part Number	Marking	I _{hold} (A)	I _{trip} (A)	V _{max} (Vdc)	I _{max} (A)	P _{d max.} (W)	Maximum Time To Trip		Resistance			Agency Approvals	
							Current (A)	Time (Sec.)	R _{min} (Ω)	R _{typ} (Ω)	R _{1max} (Ω)		
1812L010	LF010	0.10	0.30	30	100	0.8	0.50	1.50	1.600	7.000	15.000	X	X
1812L014	LF014	0.14	0.34	60	10	0.8	1.50	0.15	1.500	4.000	6.000	X	X
1812L020	LF020	0.20	0.40	30	100	0.8	8.00	0.02	0.800	2.900	5.000	X	X
1812L050-C	LF050	0.50	1.00	15	100	0.8	8.00	0.15	0.150	0.600	1.000	X	X
1812L075-C	LF075	0.75	1.50	13.2	100	0.8	8.00	0.20	0.100	0.260	0.450	X	X
1812L075/24	LF075-24	0.75	1.50	24	100	0.8	8.00	0.20	0.110	0.200	0.290	X	X
1812L075/33	LF075-33	0.75	1.50	33	20	0.8	8.00	0.20	0.110	0.260	0.400	X	X
1812L110-C	LF110	1.10	2.20	6	100	0.8	8.00	0.30	0.040	0.120	0.210	X	X
1812L110/16	LF110-16	1.10	1.95	16	100	0.8	8.00	0.50	0.060	0.120	0.180	X	X
1812L110/33	LF110-33	1.10	1.95	33	20	0.8	8.00	0.50	0.060	0.120	0.200	X	X
1812L125-C	LF125	1.25	2.50	15	100	0.8	8.00	0.40	0.050	0.160	0.250	X	X
1812L125/6	LF125-6	1.25	2.50	6	100	0.8	8.00	0.40	0.050	0.090	0.140	X	X
1812L150-C	LF150	1.50	3.00	8	100	0.8	8.00	0.30	0.040	0.070	0.110	X	X
1812L150/12	LF150-12	1.50	3.00	12	100	0.8	8.00	0.50	0.040	0.070	0.110	X	X
1812L150/24	LF150-24	1.50	3.00	24	20	0.8	8.00	1.50	0.040	0.070	0.120	X	X
1812L160-C	LF160	1.60	2.80	8	100	0.8	8.00	1.00	0.030	0.066	0.100	X	X

Electrical Characteristics (continued)

Part Number	Marking	I _{hold} (A)	I _{trip} (A)	V _{max} (Vdc)	I _{max} (A)	P _d max. (W)	Maximum Time To Trip		Resistance			Agency Approvals	
							Current (A)	Time (Sec.)	R _{min} (Ω)	R _{typ} (Ω)	R _{1max} (Ω)		
1812L160/12	LF160-12	1.60	2.80	12	100	0.8	8.00	1.00	0.030	0.066	0.100	X	X
1812L200-C	LF200	2.00	3.50	8	100	0.8	8.00	2.00	0.020	0.040	0.060	X	X
1812L260-C	LF260	2.60	5.00	6	100	0.8	8.00	2.50	0.015	0.030	0.047	X	X

I_{hold} = Hold current: maximum current device will pass without tripping in 20°C still air.
 I_{trip} = Trip current: minimum current at which the device will trip in 20°C still air.
 V_{max} = Maximum voltage device can withstand without damage at rated current (I_{max})
 I_{max} = Maximum fault current device can withstand without damage at rated voltage (V_{max})
 P_d = Power dissipated from device when in the tripped state at 20°C still air.
 R_{min} = Minimum resistance of device in initial (un-soldered) state.

R_{typ} = Typical resistance of device in initial (un-soldered) state.
 R_{1max} = Maximum resistance of device at 20°C measured one hour after tripping or reflow soldering of 260°C for 20 sec.

Caution: Operation beyond the specified rating may result in damage and possible arcing and flame.

Temperature Rerating

Part Number	Ambient Operation Temperature								
	-40°C	-20°C	0°C	23°C	40°C	50°C	60°C	70°C	85°C
Part Number	Hold Current (A)								
1812L010	0.16	0.14	0.12	0.10	0.08	0.07	0.06	0.05	0.03
1812L014	0.23	0.19	0.17	0.14	0.12	0.10	0.09	0.08	0.06
1812L020	0.29	0.26	0.23	0.20	0.17	0.15	0.14	0.12	0.10
1812L050-C	0.77	0.68	0.59	0.50	0.44	0.40	0.37	0.33	0.29
1812L075-C	1.15	1.01	0.88	0.75	0.65	0.60	0.55	0.49	0.43
1812L075/24	1.06	0.95	0.84	0.75	0.60	0.55	0.50	0.45	0.37
1812L075/33	1.10	1.00	0.88	0.75	0.66	0.60	0.56	0.47	0.36
1812L110-C	1.59	1.43	1.26	1.10	0.95	0.87	0.80	0.71	0.60
1812L110/16	1.58	1.43	1.27	1.10	0.95	0.85	0.77	0.71	0.58
1812L110/33	1.55	1.40	1.25	1.10	0.93	0.83	.073	.063	.050
1812L125-C	2.00	1.75	1.52	1.25	1.00	0.95	0.90	0.75	0.53
1812L125/6	2.00	1.75	1.52	1.25	1.00	0.95	0.90	0.75	0.53
1812L150-C	2.06	1.93	1.79	1.50	1.28	1.10	1.02	0.80	0.68
1812L150/12	2.04	1.88	1.68	1.50	1.25	1.10	1.00	0.80	0.60
1812L150/24	2.05	1.87	1.67	1.50	1.25	1.08	0.95	0.77	0.60
1812L160-C	2.20	2.06	1.91	1.60	1.36	1.17	1.09	0.85	0.72
1812L160/12	2.18	2.01	1.79	1.60	1.34	1.16	1.07	0.83	0.60
1812L200-C	3.08	2.71	2.35	2.00	1.80	1.60	1.50	1.07	0.80
1812L260-C	4.00	3.52	3.06	2.60	2.34	2.08	1.95	1.39	1.04

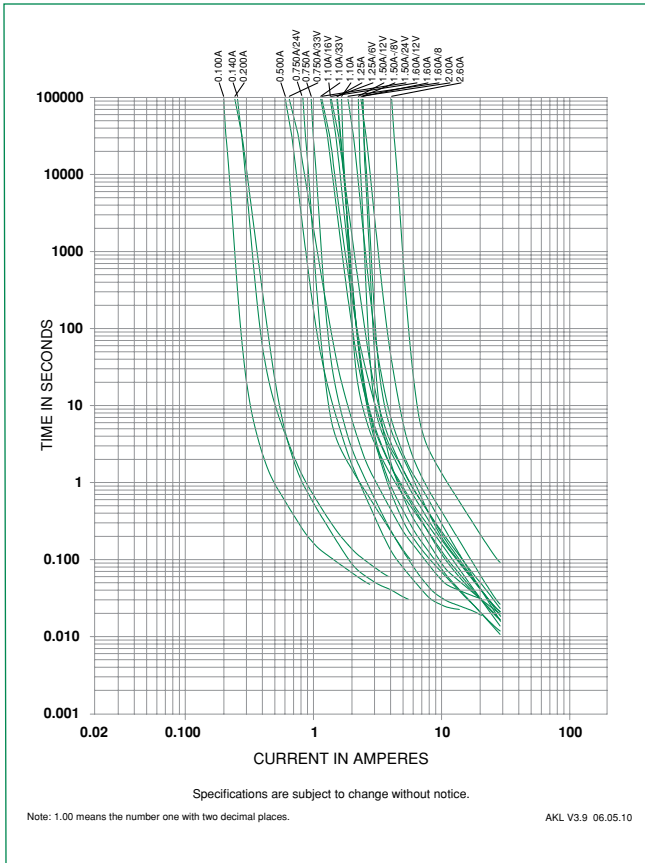
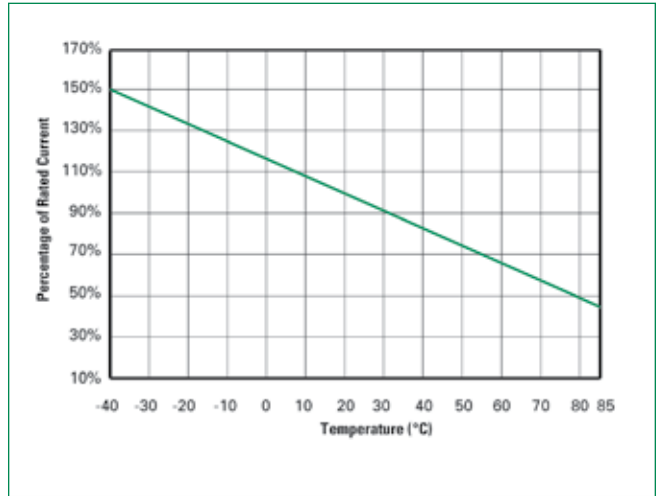
Average Time Current Curves

Temperature Derating Curve

The average time current curves and temperature derating curve performance is affected by a number of variables, and these curves provided as guidance only. Customer must verify the performance in their application.

Soldering Parameters

Condition	Reflow
Peak Temp/ Duration Time	260°C / 10 Sec
Time above liquids (TAL) 220°C	60 Sec ~ 100 Sec
Preheat 120°C~ 180°C	50 Sec ~ 150 Sec
Storage Condition	0°C~35°C, ≤70%RH

- Recommended reflow methods: IR, vapor phase oven, hot air oven, N₂ environment for lead-free
- Devices are not designed to be wave soldered to the bottom side of the board.
- Recommended maximum paste thickness is 0.25mm (0.010 inch)
- Devices can be cleaned using standard industry methods and solvents.

Note: If reflow temperatures exceed the recommended profile, devices may not meet the performance requirements.

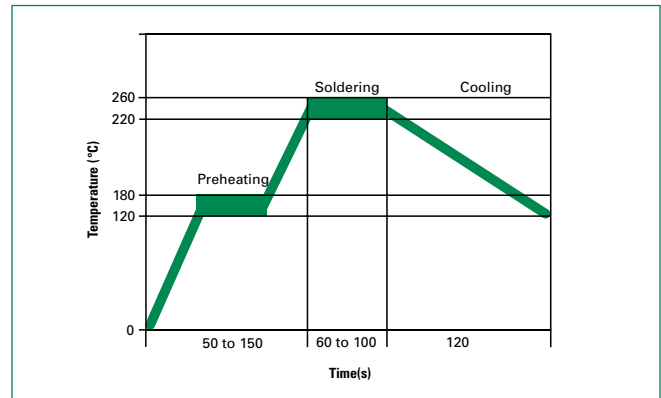

Physical Specifications

Terminal Material	Solder-Plated Copper (Solder Material: Matte Tin (Sn))
Lead Solderability	Meets EIA Specification RS186-9E, ANSI/J-STD-002 Category 3.

Environmental Specifications

Operating/Storage Temperature	-40°C to +85°C
Maximum Device Surface Temperature in Tripped State	125°C
Passive Aging	+85°C, 1000 hours ±5% typical resistance change
Humidity Aging	+85°C, 85%R.H. 1000 hours ±5% typical resistance change
Thermal Shock	MIL-STD-202 Method 107G +85°C/-40°C 20 times -30% typical resistance change
Solvent Resistance	MIL-STD-202, Method 215 No change
Vibration	MIL-STD-883C, Method 2007.1, Condition A No change

Dimensions

MARKING CODE VARIES
WITH AMPERAGE AND VOLTAGE RATING
(SEE CHART)
SHOWN ARE:
- 1.1A/6V RATING (LEFT)
- 1.1A/33V RATING (RIGHT)

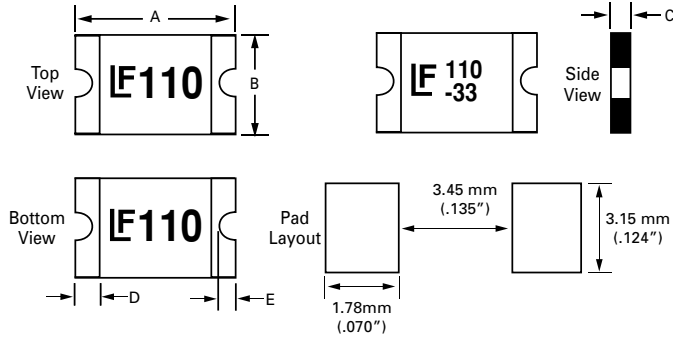

Part Number	A		B		C		D		E									
	Inches	mm	Inches	mm	Inches	mm	Inches	mm	Inches	mm								
	Min.	Max.	Min.	Max.	Min.	Max.	Min.	Max.	Min.	Max.								
1812L010	0.17	0.19	4.37	4.73	0.12	0.13	3.07	3.41	0.03	0.05	0.75	1.25	0.01	0.30	0.01	0.03	0.25	0.65
1812L014	0.17	0.19	4.37	4.73	0.12	0.13	3.07	3.41	0.03	0.08	0.75	1.95	0.01	0.30	0.01	0.03	0.25	0.65
1812L020	0.17	0.19	4.37	4.73	0.12	0.13	3.07	3.41	0.02	0.04	0.55	1	0.01	0.30	0.01	0.03	0.25	0.65
1812L050-C	0.17	0.19	4.37	4.73	0.12	0.13	3.07	3.41	0.02	0.03	0.5	0.75	0.01	0.30	0.01	0.02	0.25	0.5
1812L075-C	0.17	0.19	4.37	4.73	0.12	0.13	3.07	3.41	0.02	0.03	0.5	0.75	0.01	0.30	0.01	0.02	0.25	0.5
1812L075/24	0.17	0.19	4.37	4.73	0.12	0.13	3.07	3.41	0.03	0.06	0.75	1.55	0.01	0.30	0.01	0.03	0.25	0.65
1812L075/33	0.17	0.19	4.37	4.73	0.12	0.13	3.07	3.41	0.03	0.06	0.75	1.55	0.01	0.30	0.01	0.03	0.25	0.65
1812L110-C	0.17	0.19	4.37	4.73	0.12	0.13	3.07	3.41	0.02	0.03	0.5	0.71	0.01	0.30	0.01	0.02	0.25	0.5
1812L110/16	0.17	0.19	4.37	4.73	0.12	0.13	3.07	3.41	0.03	0.05	0.75	1.25	0.01	0.30	0.01	0.03	0.25	0.65
1812L110/33	0.17	0.19	4.37	4.73	0.12	0.13	3.07	3.41	0.05	0.08	1.2	2	0.01	0.30	0.01	0.03	0.25	0.65
1812L125-C	0.17	0.19	4.37	4.73	0.12	0.13	3.07	3.41	0.03	0.05	0.75	1.25	0.01	0.30	0.01	0.02	0.25	0.5
1812L125/6	0.17	0.19	4.37	4.73	0.12	0.13	3.07	3.41	0.02	0.03	0.45	0.75	0.01	0.30	0.01	0.03	0.25	0.65
1812L150-C	0.17	0.19	4.37	4.73	0.12	0.13	3.07	3.41	0.02	0.03	0.4	0.71	0.01	0.30	0.01	0.03	0.25	0.65
1812L150/12	0.17	0.19	4.37	4.73	0.12	0.13	3.07	3.41	0.03	0.05	0.75	1.25	0.01	0.30	0.01	0.03	0.25	0.65
1812L150/24	0.17	0.19	4.37	4.73	0.12	0.13	3.07	3.41	0.03	0.07	0.8	1.8	0.01	0.30	0.01	0.03	0.25	0.65
1812L160-C	0.17	0.19	4.37	4.73	0.12	0.13	3.07	3.41	0.02	0.03	0.4	0.75	0.01	0.30	0.01	0.03	0.25	0.65
1812L160/12	0.17	0.19	4.37	4.73	0.12	0.13	3.07	3.41	0.03	0.05	0.75	1.25	0.01	0.30	0.01	0.03	0.25	0.65
1812L200-C	0.17	0.19	4.37	4.73	0.12	0.13	3.07	3.41	0.03	0.05	0.81	1.2	0.01	0.30	0.01	0.02	0.25	0.5
1812L260-C	0.17	0.19	4.37	4.73	0.12	0.13	3.07	3.41	0.03	0.05	0.8	1.34	0.01	0.30	0.01	0.02	0.25	0.5

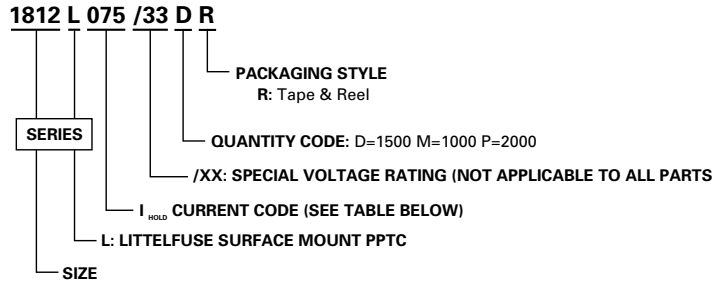
Part Numbering System

Packaging

I_{hold} (A)	I_{hold} Code	Voltage Option	Packaging Option	Quantity	Quantity & Packaging Codes
0.10	010		Tape and Reel	1500	DR
0.14	014		Tape and Reel	1500	DR
0.20	020		Tape and Reel	2000	PR
0.50	050		Tape and Reel	2000	PR
0.75	075		Tape and Reel	2000	PR
		/24	Tape and Reel	1500	DR
		/33	Tape and Reel	1500	DR
1.10	110		Tape and Reel	2000	PR
		/16	Tape and Reel	1500	DR
		/33	Tape and Reel	1000	MR
1.25	125		Tape and Reel	1500	DR
		/6	Tape and Reel	2000	PR
1.50	150		Tape and Reel	2000	ZR
		/12	Tape and Reel	1500	DR
		/24	Tape and Reel	1000	MR
1.60	160		Tape and Reel	2000	PR
		/12	Tape and Reel	1500	DR
2.00	200		Tape and Reel	1500	DR
2.60	260		Tape and Reel	1000	ZR