

TPD2005F

Low-Side Power Switch Array (8 Channels) for Motors, Solenoids, and Lamp Drivers

The TPD2005F is an 8-channel high-side switch array for vertical power MOS FET output. A monolithic power IC, it can directly drive a power load from a CMOS or TTL logic circuit (such as an MPU). It offers overcurrent and overtemperature protection functions.

Features

- A high-side switch array incorporating an N-channel power MOS FET (1.2 Ω_{max.}) and an 8-channel charge pump
- Can directly drive a power load from a microprocessor.
- Built-in protection against thermal shutdown protection and overcurrent protection
- 8-channel access enables space-saving design
- High operating voltage : 40 V
- Low on resistance : 1.2 Ω_{max.} (@V_{DD} = 12 V, I_O = 0.5 A (per channel))
- Supports parallel operation.
- Low operating current : 5 mA max. (@V_{DD} = 40 V, V_{IN} = 0 V)
- Supplied in an SSOP-24 package (300 mil) in embossed taping.

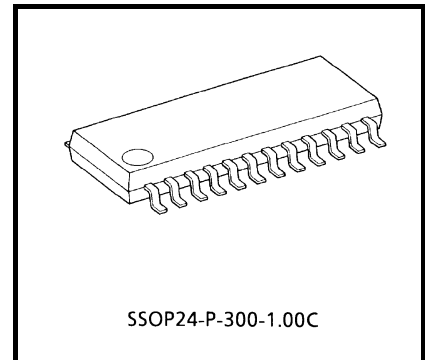

Weight: 0.29g (typ.)

Pin Assignment

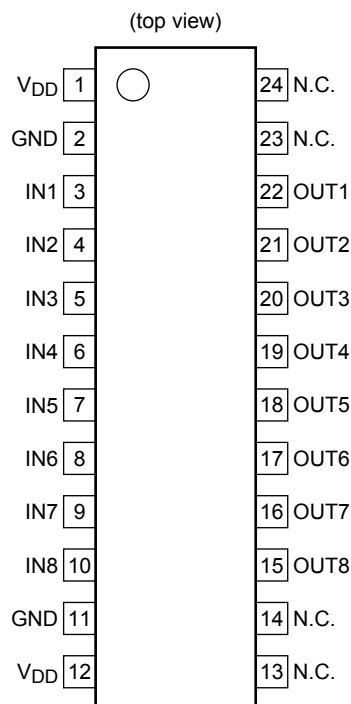

Marking

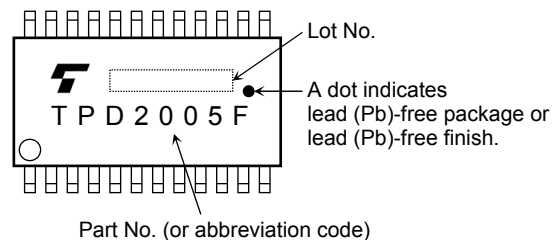

Note: Due to its MOS structure, this product is sensitive to static electricity.

Block Diagram

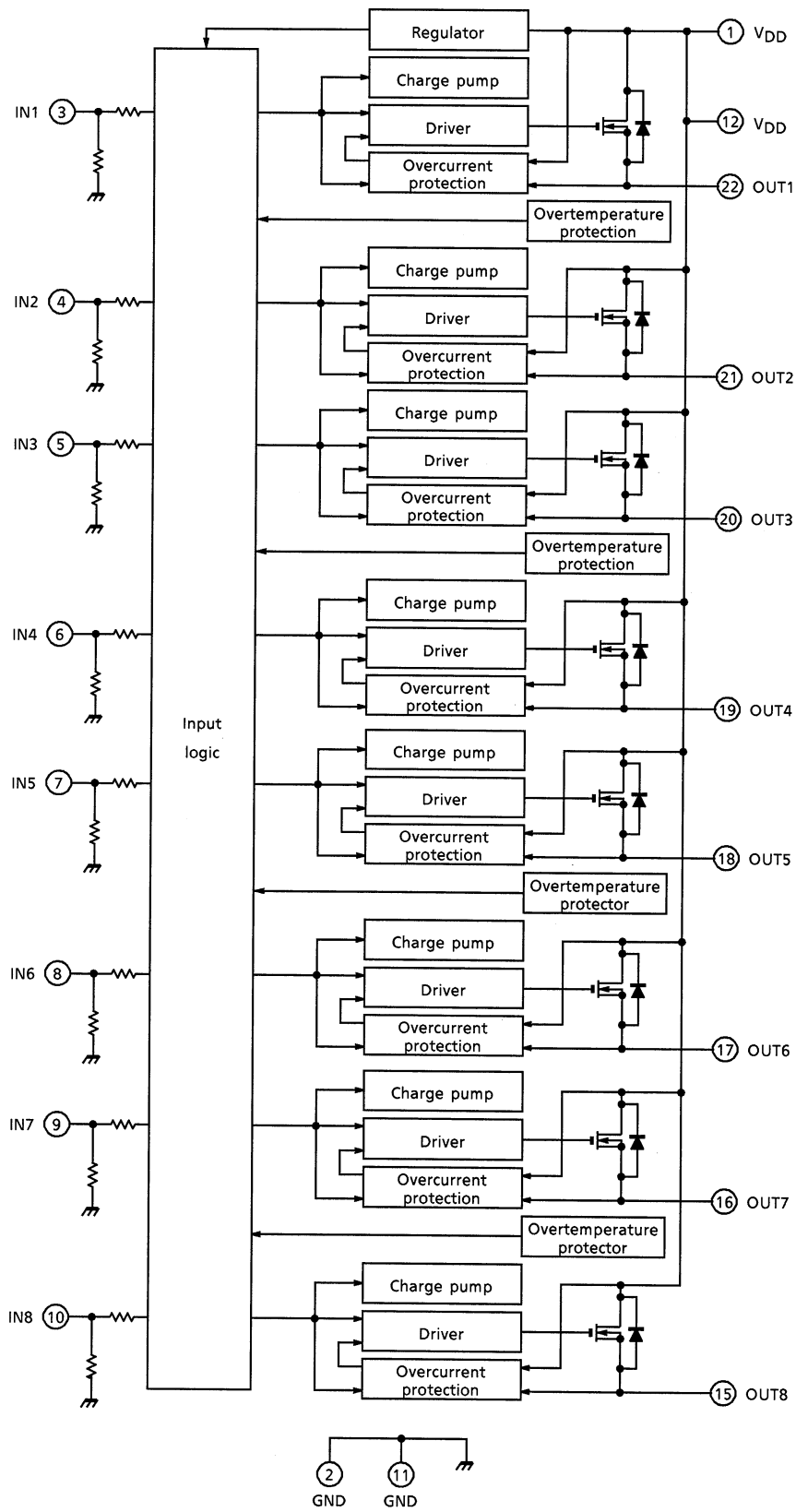

Pin Description

Pin No.	Symbol	Description
1	V _{DD}	Power supply pin; in common with the pin No.12 internally.
2	GND	GND pin; in common with the pin No.11 internally.
3	IN1	Control input pin for channel 1 and built-in pull-down resistor (100 kΩ typ.)
4	IN2	Control input pin for channel 2 and built-in pull-down resistor (100 kΩ typ.)
5	IN3	Control input pin for channel 3 and built-in pull-down resistor (100 kΩ typ.)
6	IN4	Control input pin for channel 4 and built-in pull-down resistor (100 kΩ typ.)
7	IN5	Control input pin for channel 5 and built-in pull-down resistor (100 kΩ typ.)
8	IN6	Control input pin for channel 6 and built-in pull-down resistor (100 kΩ typ.)
9	IN7	Control input pin for channel 7 and built-in pull-down resistor (100 kΩ typ.)
10	IN8	Control input pin for channel 8 and built-in pull-down resistor (100 kΩ typ.)
11	GND	GND pin; in common with the pin No.2 internally.
12	V _{DD}	Power supply pin; in common with the pin No.1 internally.
13	N.C.	—
14	N.C.	—
15	OUT8	Output pin for channel 8
16	OUT7	Output pin for channel 7
17	OUT6	Output pin for channel 6
18	OUT5	Output pin for channel 5
19	OUT4	Output pin for channel 4
20	OUT3	Output pin for channel 3
21	OUT2	Output pin for channel 2
22	OUT1	Output pin for channel 1
23	N.C.	—
24	N.C.	—

Timing Chart

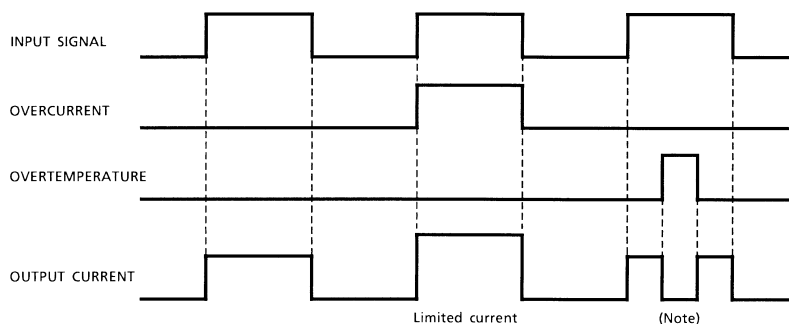

Note: The overheating detector circuits feature hysteresis. After overheating is detected, normal operation is restored only when the junction temperature falls by the hysteresis amount (10°C typ.) in relation to the overheating detection temperature.

Truth Table

Input Signal	Output Signal	State
L	L	Normal
H	H	
L	L	Overcurrent
H	Internally limited	
L	L	Overtemperature
H	L	

Absolute Maximum Ratings (Ta = 25°C)

Characteristic	Symbol	Rating	Unit
Supply voltage	V _{DD}	45	V
Input voltage	V _{IN}	- 0.5 ~ 7	V
Drain-source voltage	V _{DS}	60	V
Output current	I _O	Internally limited	A
Power dissipation (operating all channels, ta = 25°C)	P _T	0.8	W
		1.2 (Note)	
Single pulse avalanche energy	E _{AS}	10	mJ
Operating temperature	T _{opr}	- 40 ~ 85	°C
Junction temperature	T _j	150	°C
Storage temperature	T _{stg}	- 55 ~ 150	°C

Note: Using continuously under heavy loads (e.g. the application of high temperature/current/voltage and the significant change in temperature, etc.) may cause this product to decrease in the reliability significantly even if the operating conditions (i.e. operating temperature/current/voltage, etc.) are within the absolute maximum ratings and the operating ranges.

Please design the appropriate reliability upon reviewing the Toshiba Semiconductor Reliability Handbook ("Handling Precautions"/Derating Concept and Methods) and individual reliability data (i.e. reliability test report and estimated failure rate, etc).

Thermal Characteristics

Characteristic	Symbol	Rating	Unit
Thermal resistance junction to ambient (Operating all channels, Ta = 25°C)	ΣR _{th(j-a)}	156.3	°C / W
		104.2 (Note)	

Note: 60 mm × 60 mm × 1.6 mm when a device is mounted on a glass epoxy PCB (DC).

Electrical Characteristics

(Unless otherwise specified, $V_{DD} = 8 \sim 40V$, $T_j = 25^\circ C$)

Characteristic	Symbol	Test Circuit	Test Condition	Min	Typ.	Max	Unit
Operating supply voltage	V_{DD}	—	—	8	—	40	V
Supply current	I_{DD}	—	$V_{DD} = 40 V, V_{IN} = 0 V$	—	—	5	mA
Input voltage	"L" level	V_{IL}	—	—	—	1.5	V
	"H" level	V_{IH}	—	3.5	—	—	
Input current	I_{IL}	—	$V_{DD} = 24 V, V_{IN} = 0 V$	-10	—	10	μA
	I_{IH}	—	$V_{DD} = 24 V, V_{IN} = 5 V$	—	50	200	
On resistance	$R_{DS(ON)}$	—	$V_{DD} = 12 V, I_O = 0.5 A$	—	0.9	1.2	Ω
Output leakage current	I_{OL}	—	$V_{DD} = 40 V, V_{IN} = 0 V$	—	—	100	μA
Overcurrent protection	I_S	—	—	1	—	3	A
Thermal shutdown	T_{SD}	—	—	—	160	—	$^\circ C$
	ΔT_{SD}	—	—	—	10	—	
Switching time	t_{ON}	1	$V_{DD} = 12 V, R_L = 24 \Omega$	—	11	200	μs
	t_{OFF}			—	4	50	

Description of Protector Circuit

(1) Overtemperature Protection

- There are four built-in overheating detector circuits, one each for channels 1 and 2; channels 3 and 4; channels 5 and 6; and channels 7 and 8, respectively. The circuit logic is such that, when any of the four detectors detects overheating, the circuit turns off the output of both its channels (for example, both channels 1 and 2).
- The overheating detector circuits feature hysteresis. After overheating is detected, normal operation is restored only when the junction temperature falls by the hysteresis amount ($10^\circ C$ typ.) in relation to the overheating detection temperature.

(2) Overcurrent Protection

- When overcurrent is detected, the overcurrent limiter function limits the output current. Normal operation is restored when the load current drops below the overcurrent detection value.

Test Circuit

Switching Time

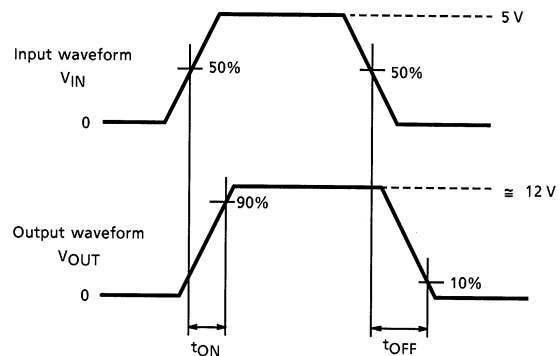
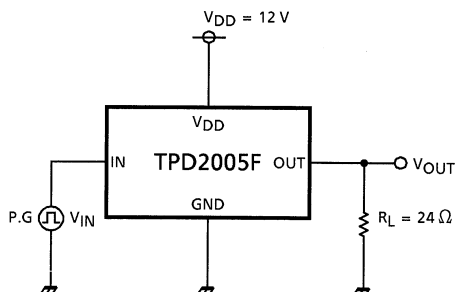

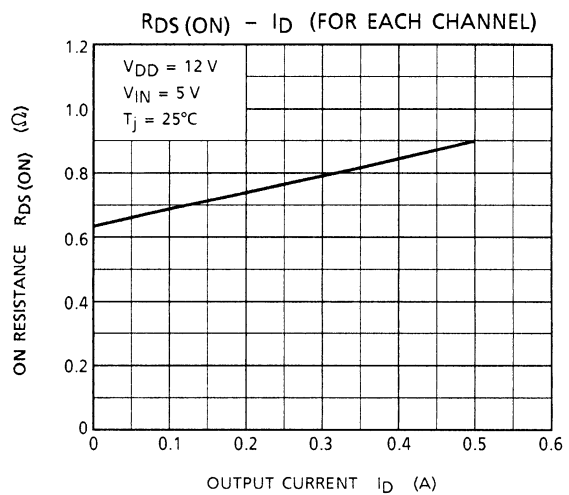
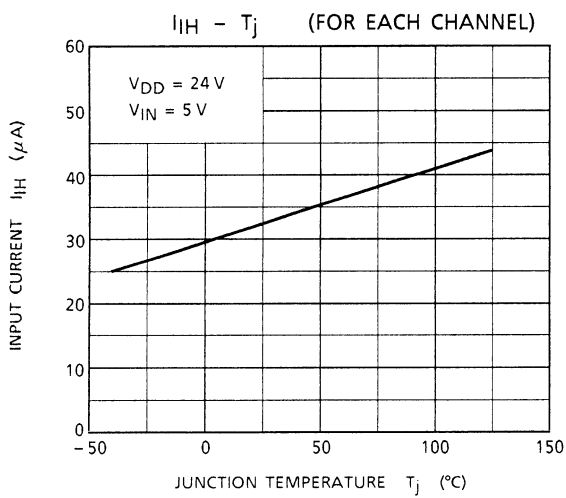
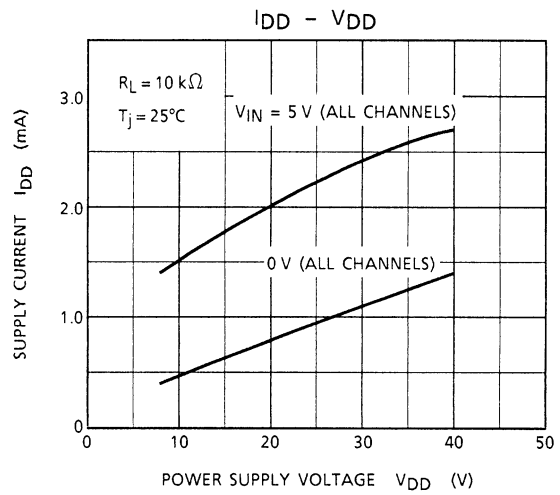
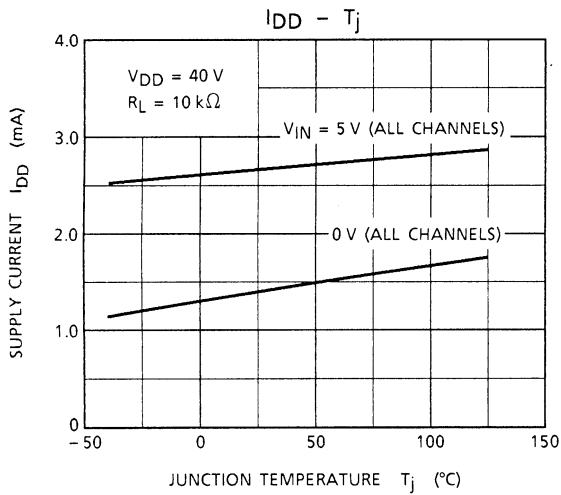
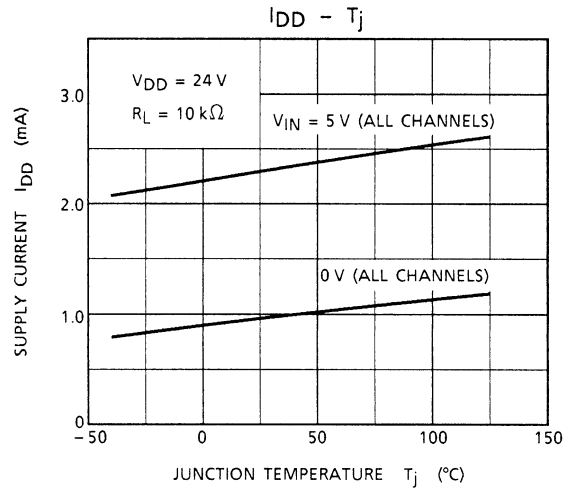
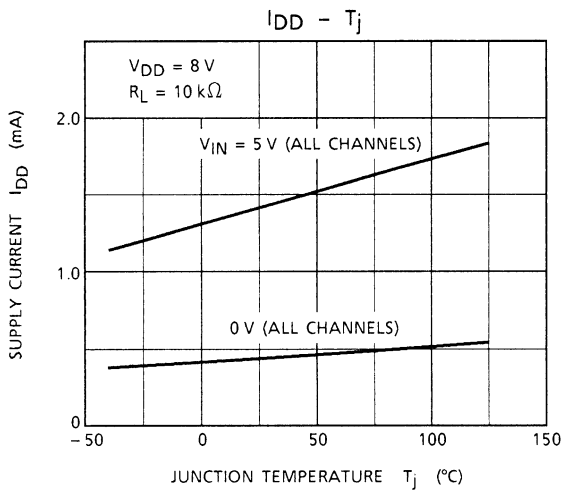

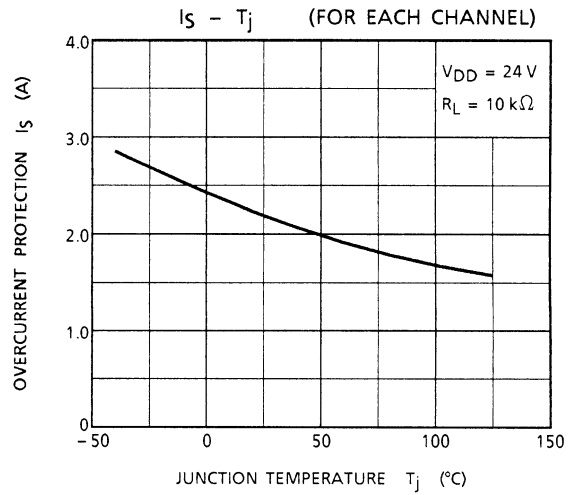
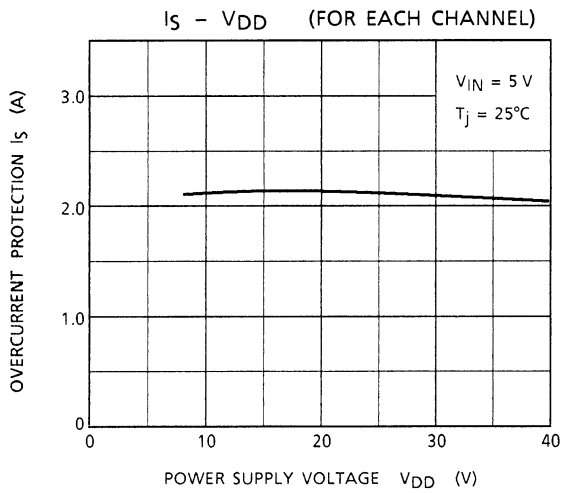
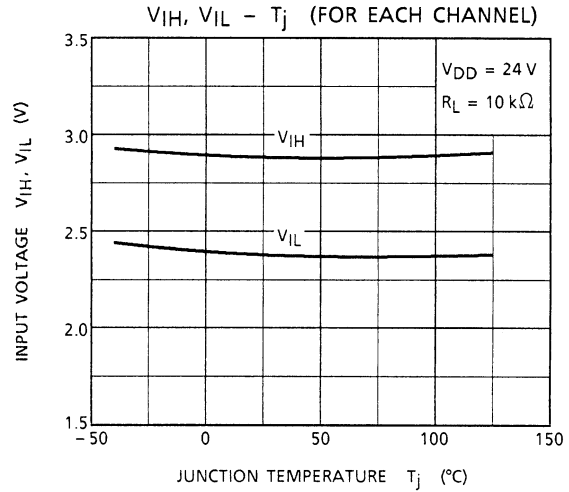
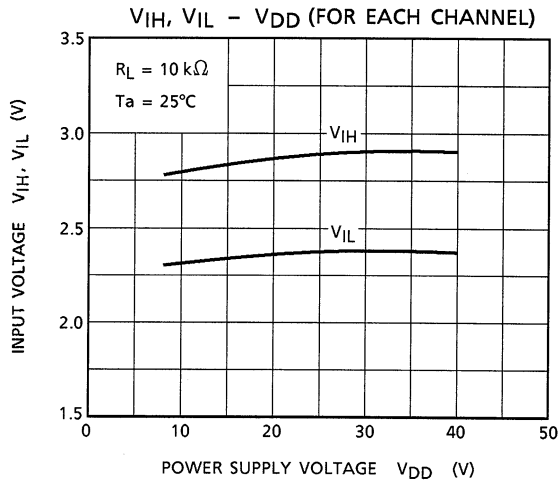
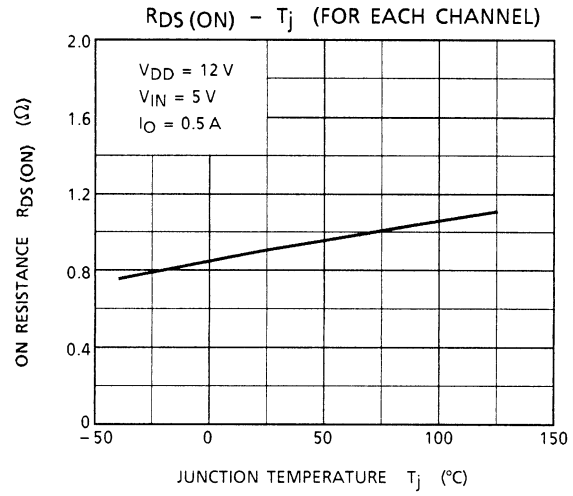
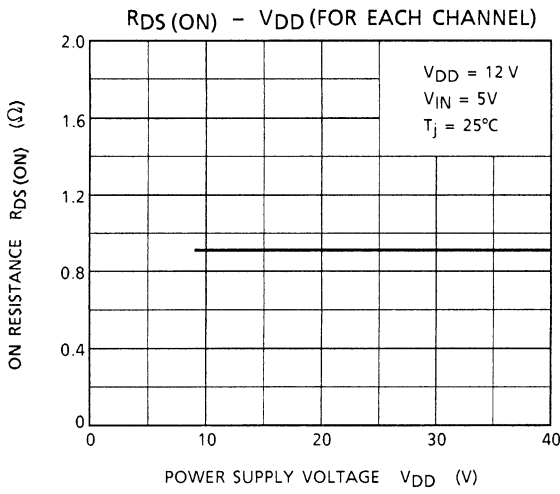

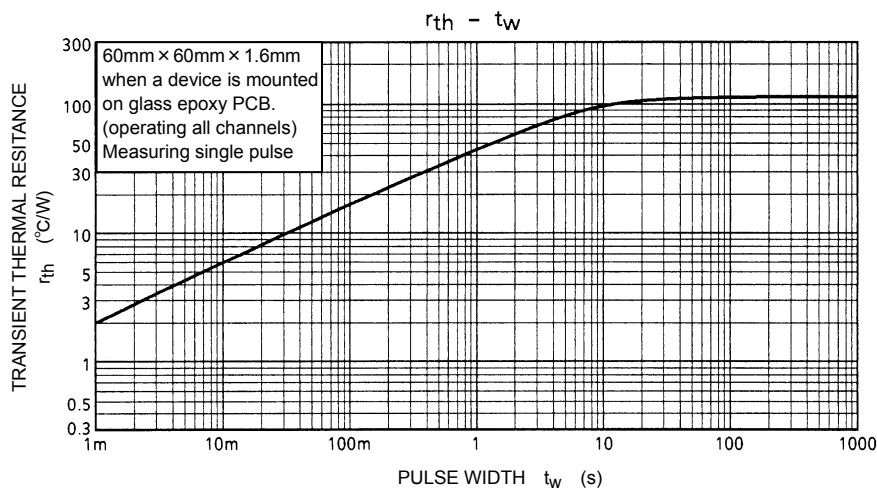
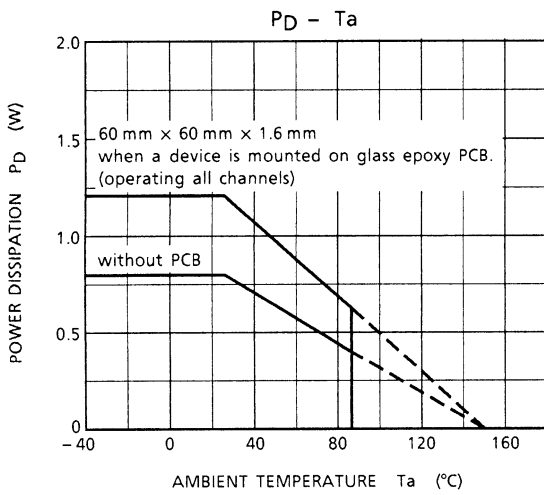
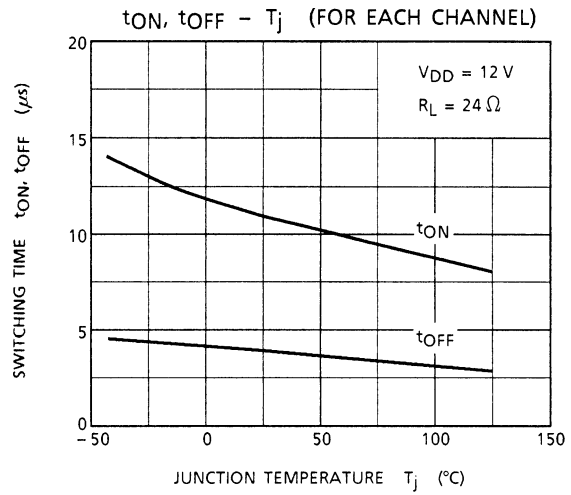
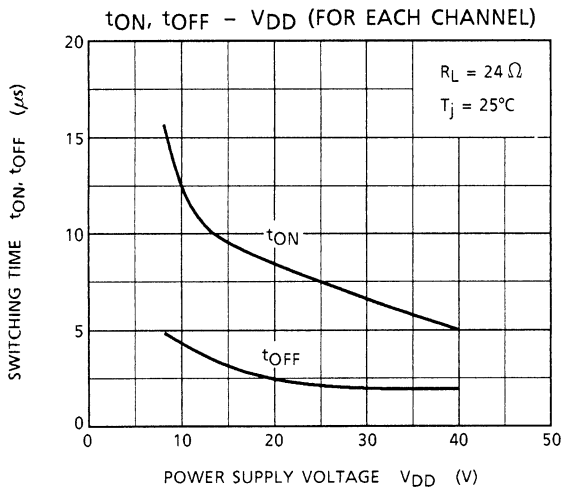

Caution on Usage

1. As protection against reverse connection of batteries is not provided, take protective measures using external circuits.
2. As a negative bias protector circuit is not built into the output pins, if negative bias is applied to the output pins, be sure to connect a freewheel diode between OUT and GND.

Moisture-Proof Packing

After the pack is opened, use the devices in a 30°C, 60% RH environment, and within 48 hours.

Embossed-tape packing cannot be baked. Devices so packed must be within their allowable time limits after unpacking, as specified on the packing.

Standard tape packing quantity: 2000 devices / reel (EL1)

Package Dimensions

SSOP24-P-300-1.00C

Unit: mm

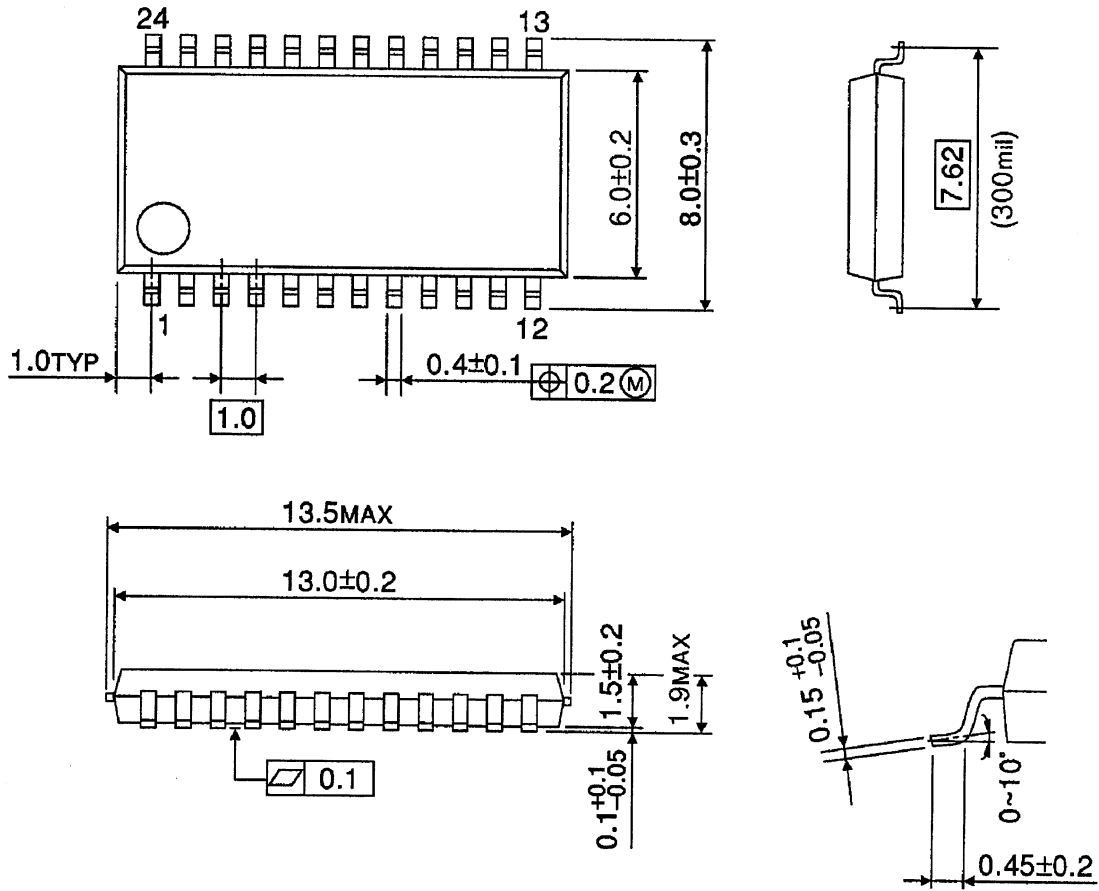

Weight: 0.29g (typ.)

RESTRICTIONS ON PRODUCT USE

20070701-EN

- The information contained herein is subject to change without notice.
- TOSHIBA is continually working to improve the quality and reliability of its products. Nevertheless, semiconductor devices in general can malfunction or fail due to their inherent electrical sensitivity and vulnerability to physical stress. It is the responsibility of the buyer, when utilizing TOSHIBA products, to comply with the standards of safety in making a safe design for the entire system, and to avoid situations in which a malfunction or failure of such TOSHIBA products could cause loss of human life, bodily injury or damage to property.
In developing your designs, please ensure that TOSHIBA products are used within specified operating ranges as set forth in the most recent TOSHIBA products specifications. Also, please keep in mind the precautions and conditions set forth in the "Handling Guide for Semiconductor Devices," or "TOSHIBA Semiconductor Reliability Handbook" etc.
- The TOSHIBA products listed in this document are intended for usage in general electronics applications (computer, personal equipment, office equipment, measuring equipment, industrial robotics, domestic appliances, etc.). These TOSHIBA products are neither intended nor warranted for usage in equipment that requires extraordinarily high quality and/or reliability or a malfunction or failure of which may cause loss of human life or bodily injury ("Unintended Usage"). Unintended Usage include atomic energy control instruments, airplane or spaceship instruments, transportation instruments, traffic signal instruments, combustion control instruments, medical instruments, all types of safety devices, etc.. Unintended Usage of TOSHIBA products listed in this document shall be made at the customer's own risk.
- The products described in this document shall not be used or embedded to any downstream products of which manufacture, use and/or sale are prohibited under any applicable laws and regulations.
- The information contained herein is presented only as a guide for the applications of our products. No responsibility is assumed by TOSHIBA for any infringements of patents or other rights of the third parties which may result from its use. No license is granted by implication or otherwise under any patents or other rights of TOSHIBA or the third parties.
- Please contact your sales representative for product-by-product details in this document regarding RoHS compatibility. Please use these products in this document in compliance with all applicable laws and regulations that regulate the inclusion or use of controlled substances. Toshiba assumes no liability for damage or losses occurring as a result of noncompliance with applicable laws and regulations.